

RADIO'S LIVEST MAGAZINE



November
25 Cents
Canada 30c

Radio-Craft

HUGO GERNSBACK Editor

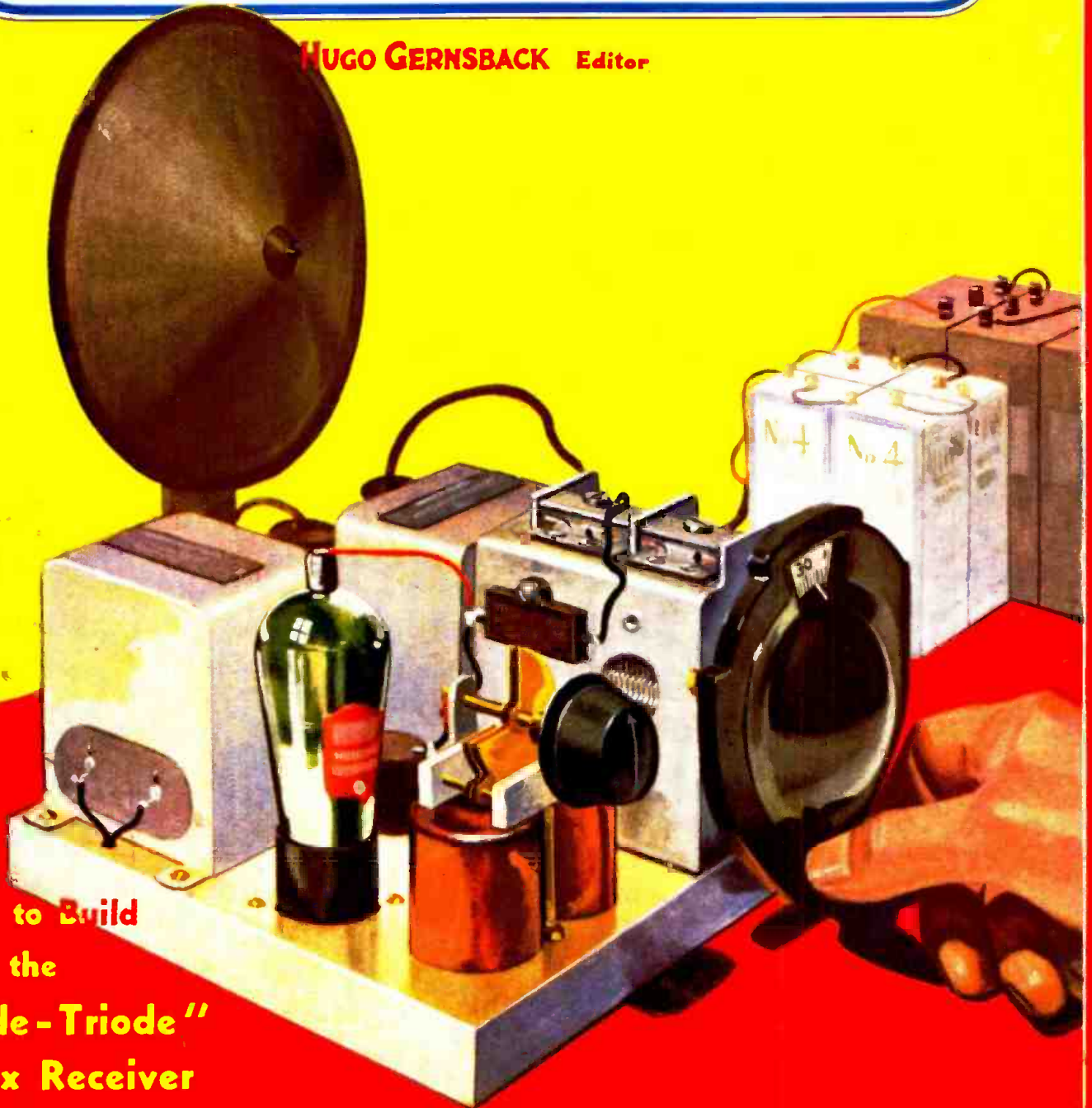

How to Build
the
"Diode-Triode"
Reflex Receiver
See Page 266

The Velocity Microphone—New Adapters—Electromagnetic Music
A Uni-Directional Loop Adapter—A Portable P. A. Amplifier

SPEED

SPEED

SPEED



EFFICIENCY!!

*Ever the Goal of the Progressive
Manufacturer*

EFFICIENCY!!

*Ever the Need of the
Service Man*

EFFICIENCY!!

*Ever Necessary to
Flawless Reception
in the Home.*

SPEED

**Gives this and more....With
Radio's Premier Tube Developments**

**TRIPLE-TWIN • TELEVISION • FOTO-LECTRIC
TUBES**

*Write for latest free bulletins—Turn to Page 320A
for our Card—Keep up with progress by contact with*

SPEED!

CABLE RADIO TUBE CORP.
230-240 NO. NINTH ST. BROOKLYN, N.Y.



**ARE YOU
"SET"
TO START
THE RACE TO
BETTER
TIMES
?**

The **TRAINED MAN** *always Wins!*

It's just as true—or even truer—in business as in sport. The man with real, practical TRAINING is the one to win. Now that business is returning to normal there's going to be a harder race to win the prizes of big-pay jobs, independence and a future, than ever before. Are you "all set" to race? Have you the necessary TRAINING to bring you in among the winners! If not, DON'T WAIT! Get the training NOW while there's still time!

Get Your Training for Work in Profitable **RADIO-TELEVISION** *in the Great Coyne School in Only 10 Weeks*

Here's the most fascinating, fastest-growing field in the world today. In Radio there are thousands of jobs paying BIG MONEY—up to \$50 a week and more. COYNE TRAINING fits you to hold better jobs—prepare to be a Designer, Inspector or Tester . . . a Radio Salesman, Service or Installation Man . . . Operator or Manager of a Broadcasting Station . . . a Wireless Operator on a Ship or Airplane . . . Coyne trains you, too, for Talk-

ing Picture and Television and Sound Work! In just a few short weeks, by exclusive Coyne methods, you are trained for a future that holds marvelous opportunities for top-notch salaries, or for a business of your own and real independence. Find out about this great game—get all particulars—see how simple it is for any ambitious man to get into it with the help of this great, nationally-recognized school.

LEARN BY DOING—NO BOOK STUDY

When you come to COYNE for training you start right in doing practical, interesting work on the greatest layout of Radio, Television and Sound Equipment you ever dreamed of seeing. Scores of the most up-to-minute Radio Receivers, real Broadcasting Equipment, latest Television Apparatus, Talking Picture and Sound Reproduction Equipment, Code Practice Equipment, etc., are here for you to use and learn by actual operation, servicing and repair. Previous experience or advanced education isn't needed. The useless theory—the tedious book study—is cut out by COYNE methods. We replace it with actual practice and experience in modern, completely equipped shops in our own huge building. The result is that you get more training in 10 weeks at COYNE than you ordinarily could in long months of tiresome book study.

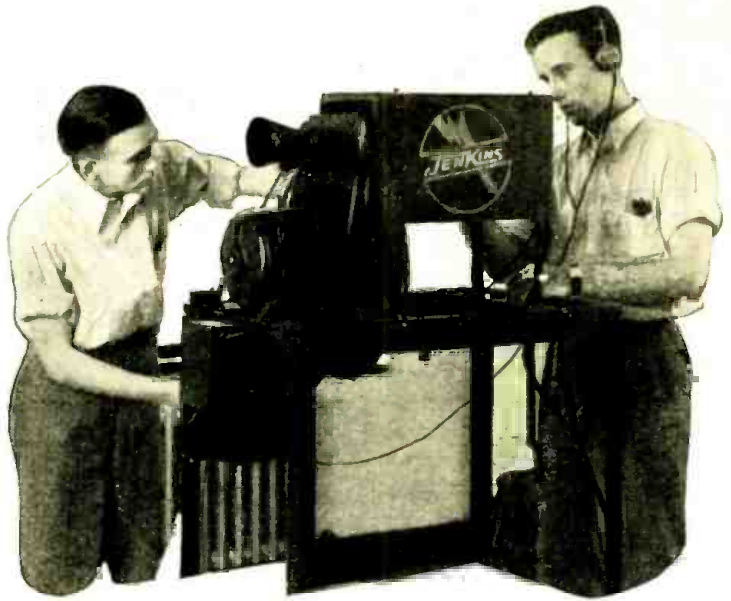

Earn as You Learn — We'll Help You

Don't let lack of ready cash hold you back in getting the TRAINING you must have to be a winner. Many COYNE students make all or a good share of their living expenses while going to school. If you need that kind of help just let me know. We run an efficient Employment Service to help you get spare-time employment while you are here—and that aids you in finding full-time jobs whenever you need them during your whole life. COYNE has been training men for nearly a THIRD OF A CENTURY—its value has been tested and proven by thousands of men who are now successful and happy. YOU can have a future like that—YOU can be one of the winners in the race of life. Why not learn how easy it is?

SEND NOW FOR BIG FREE BOOK

Just mail the Coupon! It will bring you a thrilling big book, illustrated with actual photographs taken in COYNE SHOPS and showing how our methods TRAIN you so practically that employers are glad to have you if you have a background of COYNE TRAINING. This book tells you everything you want to know about the tremendous RADIO FIELD—describes the vast opportunities that exist in it—tells about the future in it for men who know. It's a book of FACTS that is more fascinating than fiction. You'll enjoy every word of it—and it may be the means of starting you on a real, successful, prosperous career. GET IT AT ONCE. Just mail the coupon!

COYNE ELECTRICAL SCHOOL

H. C. LEWIS, President Founded 1899
500 S. Paulina St., Dept. 82-8H CHICAGO, ILL.

H. C. Lewis, President,
Radio Division, Coyne Electrical School,
500 S. Paulina St., Dept. 82-8H Chicago, Ill.
Dear Mr. Lewis: Send me your Big, FREE Radio Book, and tell me how I can get the TRAINING that will make me a WINNER.

NAME _____
ADDRESS _____
CITY _____ STATE _____



HUGO GERNSBACK, Editor-in-Chief

LOUIS MARTIN
Associate Editor

R. D. WASHBURNE
Technical Editor

CONTENTS OF THE NOVEMBER, 1932, ISSUE

VOLUME IV

Number 5

EDITORIAL:

The Decline of Radio Sets Hugo Gernsback 265

NEW DEVELOPMENTS IN RADIO:

The Latest Radio Equipment 268
Electromagnetic Music E. E. Kassel 270
A Church Sound System Karl Dobesch 271
The Velocity Microphone J. P. Taylor 272
The Crystal Microphone 273

SERVICE MEN'S DEPARTMENT:

Announcing the Weston 663 Volt-Ohmmeter
L. van der Mel 273
The Specialty Tester Jack Grand 277
A Universal Analyzer Adapter Herman Bublitz 278
Constructing Adapters for Test Equipment
F. L. Sprayberry 280
Short Cuts in Radio Service 282
Operating Notes Charles Wackid 284
The Service Man's Forum 285

RADIO SERVICE DATA SHEETS:

No. 77: Kolster Models K-140 and K-142, 10-Tube
Superheterodynes 286
No. 78: Columbia Models C-90A and C-90B, 11-Tube
Superheterodynes 287

TECHNICAL RADIO TOPICS:

How to Build the "Diode-Triode" Reflex Receiver
R. D. Washburne and Francis R. Harris 266
How to Build and Operate A Uni-Directional Loop
Adapter C. W. Palmer 274
A Universal P.A. Amplifier Leon J. Littmann 276
RADIO-KRAFT Kinks 279
An All-Wave Superheterodyne E. H. Scott 288
The Radio Craftsman's Page 290
RADIO-CRAFT'S Information Bureau 291
Quasi-Optical Home Experiments John B. Brennan 295
Over-the-Counter Suggestions Jack Grand 296
Book Review 309
"Potentiometer Shunt" Resistance Tester
H. Harrison 320A
Measuring Soldering Iron Temperature
Arthur Vaughn 320B

IN OUR NEXT FEW ISSUES:

A "2-VOLT" SUPERHETERODYNE. Not everyone has the good fortune of an available power line; still others prefer battery operation—this new job will satisfy both interests. New tubes, a new circuit arrangement, and easy to build.

NOISE METERS. Some interesting information concerning the instrument that visually indicates the proportion of noise which exists in our sphere of everyday activity.

HOW TO CONSTRUCT A MUTUAL CONDUCTANCE METER. It is one thing to say that a tube is "good," or "bad," but it is another to find exactly HOW MUCH. Technicians must have the FACTS which this meter makes available.

INTERESTING USES FOR YOUR RADIO SET. Receivers incorporate many structural elements that may be conveniently adapted to numerous uses, as the authors show.

RADIO-CRAFT is published monthly, on the fifth of the month preceding that of date; its subscription price is \$2.50 per year. (In Canada and foreign countries, \$3.00 a year to cover additional postage.) Entered at the post office at Mt. Morris, Ill., as second-class matter under the act of March 3, 1879. Trademark and copyright by permission of Gernsback Publications, Inc., 98 Park Place, N. Y. C.

Text and illustrations of this magazine are copyright and must not be reproduced without permission of the copyright owners. We are also agents for WONDER STORIES and WONDER STORIES QUARTERLY. Subscription to these magazines may be taken in combination with RADIO-CRAFT at reduced Club rates. Write for information.

Copyright 1932. GERNSBACK PUBLICATIONS, INC.

H. GERNSBACK, President
S. GERNSBACK, Treasurer

J. M. HERZBERG, Vice-President
I. S. MANHEIMER, Secretary

Published by **TECHNI-CRAFT PUBLISHING CORPORATION**. Publication office: 404 No. Wesley Ave., Mount Morris, Illinois. Editorial and Advertising Office: 96-98 Park Place, New York City. Chicago Advertising Office: 737 North Michigan Avenue, Chicago, Ill. Western Advertising office: 220 No. Catalina St., Los Angeles, Calif. L. F. McClure, Chicago Advertising Representative. Loyd B. Chappell, Western Advertising Representative.

London Agent: Hachette & Cie., 3 La Belle Sauvage, Ludgate Hill, E.C. 4
Paris Agent: Hachette & Cie.,
111 Rue Reaumur
Australian Agent: McGill's Agency
179 Elizabeth St., Melbourne

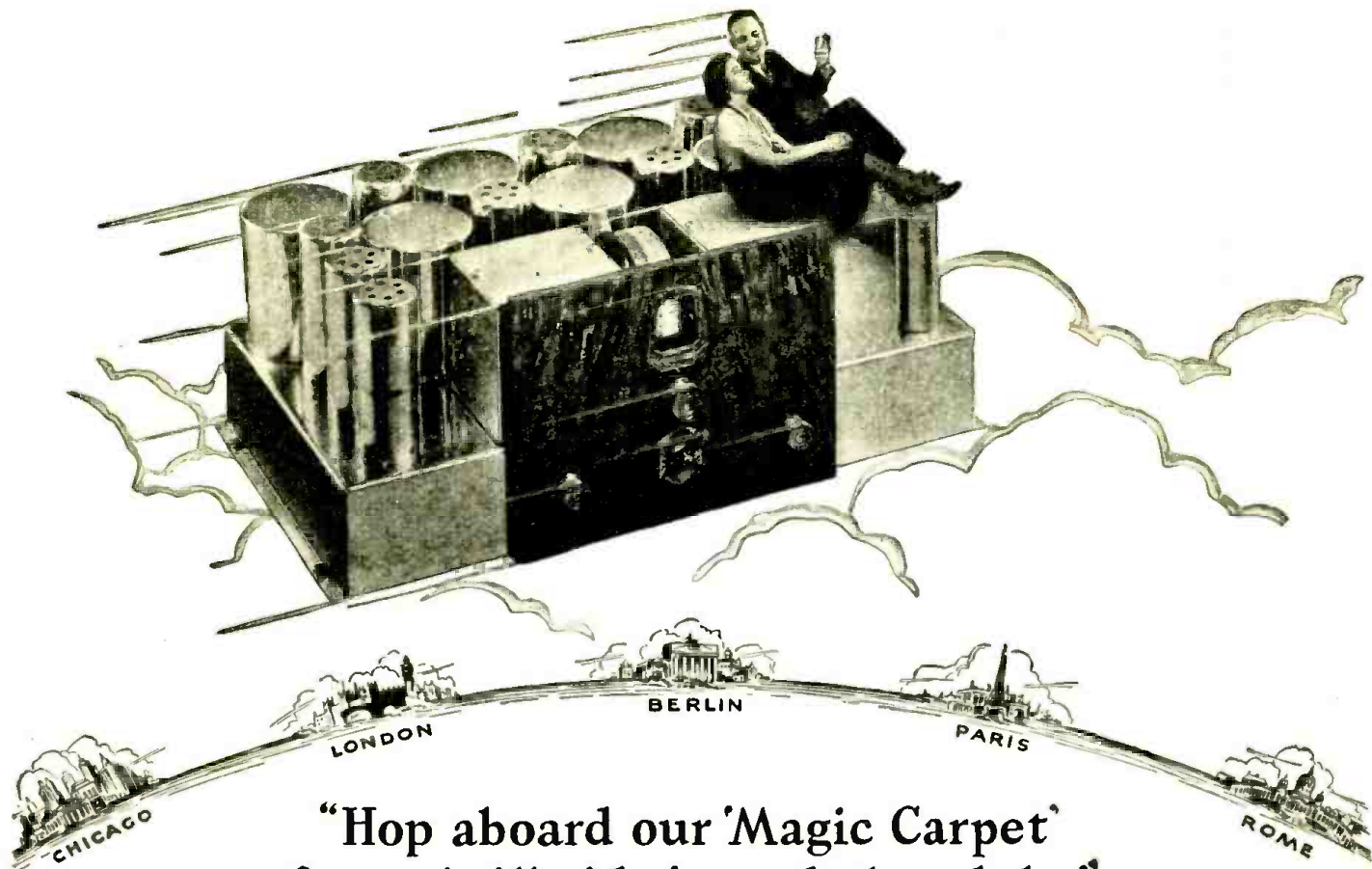

“Hop aboard our ‘Magic Carpet’
for a thrill-ride ‘round the globe”
LONDON · PARIS · ROME · MADRID

JUST turn a switch and—z-i-p! we’re off on a world tour via radio. Because it’s a new **SCOTT ALLWAVE DELUXE** there’ll be no fussing and fumbling about—only one dial to tune, no coils to plug in, no trimmers to adjust carefully. Just use the convenient log furnished with the set and the foreign station you want—maybe 10,000 miles or more away—comes in on the dot.

Let’s Start to Merrie England!

Let’s try G5SW, Chelmsford, England. Get it any day between 3:00 and 6:00 P.M. Hear peppy dance music from the Hotel Mayfair in London (Yes, those Britishers furnish music that’s as “hot” as any orchestra in the States!). Then, too, there are world news broadcasts that tell listeners all over the far-flung British Empire the news of the day in the homeland. At 6:00 P.M. (Midnight London time) it’s thrilling to hear “Big Ben,” in the House of Parliament, strike the hour of midnight in a sonorous voice.

Foreign Reception Every Day in the Year

Tired of the English program, eh? Like something French? That’s easy—let’s go to gay Parcc.

Here’s Radio Colonial, Paris, France, and it is on the air for the **SCOTT ALLWAVE DELUXE** any day between 3:00 and 6:00 P.M. Hear those dulcet tones of a spirited Mademoiselle? What, you can’t understand French? Never mind, here’s an orchestra and a song. Music is a universal language. This is Monday—that’s lucky, for there’ll be an hour’s talk in English today about the encampment of the Veterans of Foreign Wars to be held in Paris in 1935.

10,000-Mile Distant Stations Guaranteed

Unusual to get such reception? Not at all for this receiver. This new **SCOTT ALLWAVE DELUXE** is guaranteed to bring it in like that—yes, absolutely guaranteed to bring in foreign stations 10,000 miles or more away, every day of every week in the year, with loud speaker volume.

How can they make such a guarantee? Well, chiefly because the **SCOTT ALLWAVE DELUXE** is a custom-made receiver. It is built with as much care and

precision as a fine watch. There’s skilled designing and engineering behind it too—as well as parts good enough to carry a five-year guarantee against failure.

Most Perfect Tone Quality in Radio

Want to hear some more? Sure! Where do you want to go? Germany? All right. Here’s Zeesen. It can be **SCOTT**-ed any morning between 9:30 and 11:00. From it you will hear about the grandest symphony concerts put on the air any place. You’ll be glad your **SCOTT ALLWAVE DELUXE** has such exquisite tone. And it is exquisite tone! So perfect that, in a studio test, observers were unable to distinguish between the actual playing of a pianist and the **SCOTT** reproduction of a piano solo from a broadcasting station when the set and the pianist were concealed behind a curtain.



Tired of Germany? Then let’s jump to Spain on our “Magic Carpet.” Here’s EAQ, Madrid. Hear the castanets and guitars! Always typically Spanish music from this station between 7:00 and 9:00 P.M. You’ll enjoy EAQ doubly because they thoughtfully make their announcements in both English and their native tongue.

Opera Direct from the Eternal City

Want a quick trip farther south? Here’s Rome—12RO. The lady announcer’s voice is saying, “Radio Roma, Napoli.” From here, between 3:00 and 6:00 P.M. daily, you’ll hear grand opera with its most gorgeous voices and with the finest accompaniments.

So you want to hear what’s doing on the other side of the world now? That’s easy, let’s get up early and pick up VK2ME, from Sydney, Australia, any Sunday morning between 5:00 and 8:30 A.M., or VK3ME, Melbourne, any Wednesday or Saturday morning, between 4:00 and 6:30 A.M. Hear the call of the famous bird of the Antipodes—the Kookaburra. There’ll be

an interesting and varied program, music, and always a talk on the scenic or industrial attraction of the country.

Australian Stations Sound Close as Home

Can I get Australia easily? Why, of course you can! In a test didn’t one **SCOTT ALLWAVE** pick up every regular program from VK2ME in Chicago, 9,500 miles away, over a whole year’s time? Quite a record? You bet! And what’s more, the programs received were recorded on phonograph records, and one was even played back to Australia over long distance telephone, and they heard it clear as a bell! That’s performance!

These are but a few of the more than 200 foreign stations that may be heard by **SCOTT** owners.

Tired of foreign travel? Well, let’s jog about the STATES—or Canada or Mexico—on the regular broadcast frequencies. Wonderful? You bet! There was never finer reception. Or you can eavesdrop on police calls, international phone transmission, gabbing amateur wireless telephony fans. Your fun with a **SCOTT ALLWAVE DELUXE** is unlimited.

New Values! Prices Lowest Ever!

Too expensive for you? Not at all! A **SCOTT ALLWAVE DELUXE** won’t cost you more than any good model of an ordinary receiver. And it gives so much more in pleasure and satisfaction!

You’d like to know more about it—the technical details, and proofs of those wonderful performances? Easy! Just tear out the coupon below, fill in your name and address, and mail it TODAY.

THE E. H. SCOTT RADIO LABORATORIES, INC.
4450 Ravenswood Ave., Dept. C-112, Chicago, Ill.

Tell me how I can have a **SCOTT ALLWAVE DELUXE** for a “Magic Carpet” of my own, and send me complete technical details, proofs of performance, and complete information.

Name.....
Address.....
City..... State.....



More Money

I show beginners how
-- experienced service men

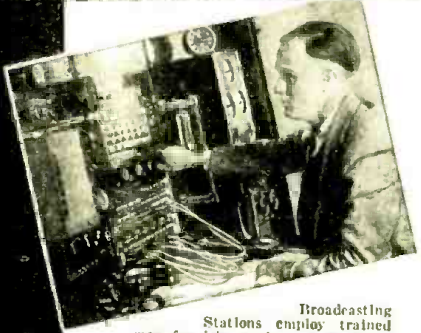

Broadcasting Stations employ trained men for jobs paying up to \$5,000 a year.



Television—the coming field of many great opportunities—is covered by my course.



Spare time set servicing pays many N.R.I. men \$200 to \$1,000 a year. Full time men make as much as \$50, \$65, and \$75 a week.



Talking Movies—an invention made possible by Radio—employs many well trained Radio men for jobs paying as much as \$75 to \$200 a week.

My book, "Rich Rewards in Radio," gives you full information on the opportunities in Radio and explains how I train beginners at home to become Radio Experts and experienced service men for better Radio jobs—better pay. It's free. Clip and mail the coupon NOW. Radio's amazing growth has made hundreds of fine jobs which pay \$50, \$60, \$75, and as much as \$100 a week. Many of these jobs lead to salaries as high as \$125 and \$150 a week.

Radio—the Field with a Future

Once or twice in a man's lifetime a new business is started in this country. You have seen how the men and young men who got into the automobile, motion picture, and other industries when they were started had the first chance at the big jobs—the \$5,000, \$10,000, and \$15,000 a year jobs. Radio offers the same chance that made men rich in those businesses. It has already made many men independent and will make many more wealthy in the future. You will be kicking yourself if you pass up this once-in-a-lifetime opportunity for financial independence.

Many Radio Experts make \$50 to \$100 a week

In the short space of a few years, 300,000 Radio jobs have been created, and thousands more will be made by its future development. Men with the right training—the kind of training I will give you in the N.R.I. Course—have stepped into Radio at 2 and 3 times their former salaries. Experienced service men as well as beginners praise N.R.I. training for what it has done for them.

Many make \$5, \$10, \$15 a week extra in spare time almost at once

My Course is world-famous as the one "that pays for itself." The day you enroll I send you material, which you should master quickly, for doing 28 Radio jobs common in most every neighborhood. Throughout your Course I will show you how to do other repair and service jobs on the side for extra money. I will not only show you how to do the jobs, but how to get them. I'll give you the plans and ideas that have made \$200 to \$1,000 a year for N.R.I. men in their spare time. G. W. Page, 110 Raleigh Apts., Nashville, Tenn., wrote me: "I made \$935 in my spare time while taking your Course." My book, "Rich Rewards in Radio," gives many letters from students who earned four, five, and six times their tuition fee before they graduated.

Get ready for jobs like these

Broadcasting stations use engineers, operators, station managers and pay up to \$5,000 a year. Radio manufacturers

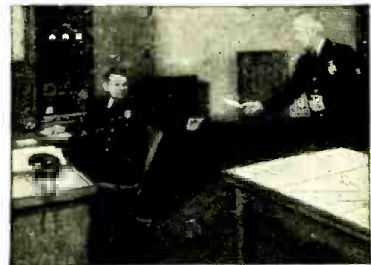

Police Departments are finding Radio a great aid in their work. Many good jobs have been made in this new field.

Some Radio Firms That Have Hired N. R. I. Men

Atwater-Kent
Crosley Radio Corp.
City of Akron (Police Dept.)
DeForest Radio Co.
F. A. D. Andrea Co.
General Electric Mfg. Co.
Grigsby-Grunow Co.
Kulster
National Broadcasting Co.
Pan-American Airways
Paramount Sound Studios
Philco-Phila. Storage Battery Co.
Radio Corp. of America
Radio Corp. of China
Stewart-Warner Corp.
Stromberg-Carlson Mfg. Co.
U. S. Army
U. S. Navy
U. S. Naval Research Lab.
U. S. Coast Guard
U. S. Dept. of Commerce
Westinghouse Electric Co.
Western Electric Co.
Zenith Radio Corp.
American Tel. & Tel. Co.
Thomas A. Edison, Inc.
Pacific Air Transport Broadcasting Stations.

WRC	WSIX
KSH	WHAD
PWX	WLW
WMAQ	WENR
WJAX	WEIB
WBOW	WKJQ
WOL	WRNY
WCHD	WQAM
KMOX	WCSR
KWWG	WGHI

Some of the Jobs N. R. I. Trains Men For

- Broadcast Engineer
- Maintenance Man in Broadcasting Station
- Installation Engineer of Broadcast Apparatus
- Operator in Broadcast Station
- Aircraft Radio Operator
- Operator of Airway Beacons
- Service Man on Sound Picture Apparatus
- Operator of Sound Picture Apparatus
- Ship Operator
- Service Man on Public Address Systems
- Installation Engineer on Public Address Systems
- Sales Manager for Retail Stores
- Service Manager for Retail Stores
- Auto Radio Installation and Service Man
- Television Broadcast Operator
- Set Servicing Expert

Act! MAIL COUPON Today - - - Get The Facts About

for You in Radio

**to get into Radio quickly
how to get better jobs-better pay**

Here's Proof



\$400 Each Month

"I spent fifteen years as travelling salesman and was making good money, but could see the opportunities in Radio. Tell me, I am not sorry, for I have made more money than ever before. I have made more than \$100 each month and it really was your course that brought me to this. I can't say too much for your school." J. G. Dahlstead, Radio Station KVA, San Francisco, Cal.



Radio Service Man Doubles Salary

"I spent 15 years building and repairing Radios, but felt I could refresh my memory and learn about development I had overlooked. Upon completion, I was appointed Service Manager of Park & Hull, and was immediately repaid for the cost and time spent in study. I give the N.R.I. full credit for my success in the Radio field—it immediately increased my earnings 100%." J. E. McLaughlin, 1511 Gullford Ave., Baltimore, Md.



From \$10 to \$50 a week in spare time

"Besides being employed by the Power & Light Company to locate Radio interference in this district, which is a very good position, I have a service business of my own that nets me from \$10 to \$50 a week in spare time. I owe all my success to the National Radio Institute, as I was only a common factory worker before taking the course." H. L. Penie, 812 W. High Street, Lima, Ohio.

employ testers, inspectors, foremen, engineers, service men, buyers, and managers for jobs paying up to \$6,000 a year. Radio dealers and jobbers (there are over 35,000) employ service men, salesmen, buyers, managers and pay up to \$100 a week. Radio operators on ships enjoy life, see the world, with board and lodging free, and get good pay besides. Talking pictures pay as much as \$75 to \$200 a week to men with Radio training. There are hundreds of opportunities for you to have a spare time or full time Radio business of your own—to be your own boss. I'll show you how to start your own business with practically no capital—how to do it on money made in spare time while learning. My book tells you of other opportunities. Be sure to get it at once. Just clip and mail the coupon.

You can learn at home in your spare time to be a Radio Expert

Hold your job. There is no need for you to leave home. I will train you quickly and inexpensively during your spare time. You don't have to be a high school or college graduate. My Course is written in a clear, interesting style that most anyone can grasp. I give you practical experience under my 50-50 method of training—one-half from lesson books and one-half from practical experiments with equipment given without extra charge. This unique and unequalled method has been called one of the greatest developments in correspondence Radio training. N.R.I. pioneered and developed it. It makes learning at home easy, fascinating, practical.

Learn the secrets of Short Wave, Television, Talking Pictures, Set Servicing, Broadcasting

I'll give you more training than you need simply to get a job—I'll give you your choice, and not charge you extra either, of my Advanced Courses so that you may SPECIALIZE in these subjects—(1) Television, (2) Set Servicing and Merchandising, (3) Sound Pictures and Public Address Systems, (4) Broadcasting, Commercial and Ship Radio Stations, (5) Aircraft Radio. Advanced specialized training like this gives you a decided advantage.

Your Money Back if you are Not Satisfied

I will give you an agreement in writing, legal and binding upon this Institute, to refund every penny of your money upon completing my Course if you are not satisfied with my Lessons and Instruction Service. The resources of the National Radio Institute, Pioneer and World's Largest Home-Study Radio School, stands behind this agreement.

Find out what Radio offers you. Get my book AT ONCE

One copy of my valuable 64-page book, "Rich Rewards in Radio," is free to any resident of the U. S. and Canada over 15 years old. It has started hundreds of men and young men on the road to better jobs and a bright future. It has shown hundreds of men who were in blind alley jobs, how to get into easier, more fascinating, better paying work. It tells you what my graduates are doing and making, where the good jobs are in Radio, what they pay, how you can quickly and easily fit yourself to be a Radio Expert. The Coupon will bring you a copy free. Send it at once. Your request does not obligate you in any way. ACT NOW.

J. E. SMITH, President
Dept. 2MX, National Radio Institute
Washington, D. C.

SPECIAL Radio Equipment for Broad Practical Experience Given Without Extra Charge

My course is not all theory. I'll show you how to use my special Radio Equipment for conducting experiments and building circuits which illustrate important principles used in such well-known sets as Westinghouse, General Electric, Philco, R.C.A., Victor, Majestic, and others. You work out with your own hands many of the things you read in our lesson books. This 50-50 method of training makes learning at home easy, interesting, fascinating, intensely practical. You learn how sets work, why they work, how to make them work when they are out of order. Training like this shows up in your pay envelope—when you graduate you have had training and experience—you're not simply looking for a job where you can get experience.



With N.R.I. equipment you learn to build and thoroughly understand set testing equipment—you can use N.R.I. equipment in your spare time service work for extra money.

I have doubled and tripled the salaries of many. Find out about this tested way to **BIGGER PAY**



FILL OUT AND MAIL THIS COUPON TODAY

Mr. J. E. SMITH, President
National Radio Institute, Dept. 2MX
Washington, D. C.

Dear Mr. Smith: Send me your book, "Rich Rewards in Radio," which points out the opportunities for spare time and full time jobs in Radio and your famous 50-50 method of training men to become Radio experts through home study. This request does not obligate me.

Name.....

Address.....

City.....State.....

The Famous Course That Pays For Itself

A NEW FREE SERVICE

Booklets that will be mailed to you free if you send in coupon below

75. SOLAR ELECTROLYTIC CONDENSERS

This catalog presents electrolytic condensers of both the wet and dry types, and includes an unusual variety. Several of the condensers are of new design and are being adopted for the latest models of receivers. Practically all types of fixed condensers generally used in radio sets during the past few years are incorporated in the line. They range from little molded mica condensers to large multiple section electrolytics for filter and power factor correction purposes, and can be had in many different mechanical sizes and shapes. Valuable technical information, such as capacity and D.C. leakage at varying temperatures, effect of frequency changes on capacity and power factor, etc., is also given. This catalog contains 16 pages and is bound in a durable paper cover. *Solar Manufacturing Corporation.*

76. THE COAST-TO-COAST "BROADCAST"

The "Broadcast" is the Fall 1932 edition of a 100-page mail order catalog that is a veritable encyclopedia. Its listings are very varied, and run from soldering lugs to complete 100-watt public address amplifiers. Every article is well illustrated and described for the benefit of radio dealers and Service Men, for whom the volume is specifically intended.

More than 25 per cent of this catalog is devoted to public address amplifiers and equipment, on which the engineers of the company have done considerable work. A number of special amplifiers for both portable and stationary use are described, and special attention is given to a universal 15-watt job that performs equally well either from 110 volts A.C. or a storage-battery operated A.C. power unit. In view of the fact that 1932 is a year of unusual political importance, with many candidates for public office taking to the microphone, an amplifier of this type is likely to be a very profitable item for the Service Man. Many useful technical hints on P.A. operation are included.

A large amount of space is also given to replacement power transformers, condensers and resistors for ordinary service work. This catalog is well prepared and is worth saving. *Coast-to-Coast Radio Corporation.*

77. SAMSON MICROPHONES AND ACCESSORIES

The well-known line of Samson "PAM" amplifiers is now being supplemented by a

Radio-Craft READERS' BUREAU

On this page are listed booklets, catalogs, pamphlets, etc., of Manufacturers, Schools, Institutions, and other organizations, which may be of interest to readers of "Radio-Craft." The list is revised each month, and it will be kept as up-to-date and accurate as possible. In all cases the literature has been selected because of the valuable information which the books contain.

This Service is absolutely free to all Readers of "Radio-Craft."

Fill in and mail the coupon below; make sure that your name and address are included and are plainly written. Order by number only.

series of high quality microphones and accessories, which are described in a bulletin which gives their technical characteristics. The first seven "mikes" are of the double-carbon-button type. Four of these are intended for suspension in the familiar ring stand, two are of the hand type, and the last resembles an ordinary desk telephone. The second group comprises three dynamic microphones, which use the same unit in different forms of mounting. The third and last group is a pair of condenser "mikes" designed for broadcasting purposes. All these microphones are of interest to public address and broadcasting specialists. *Samson Electric Company.*

78. MAKING AUTO RADIO SETS ALL ELECTRIC

The popularity of the auto radio set has stimulated radio engineers toward the development of economical and satisfactory sources of "B" power to replace batteries. One of the most successful devices brought out so far is the Carter Genemotor, which is described in a folder of the above name. This machine is a small rotary converter that operates on the car's six-volt storage battery and supplies smooth direct current at 135 or 180 volts at current drains of 20 or 30 milliamperes, depending on the par-

ticular model. The outstanding feature of this converter is its low current consumption, which is less than two amperes. As this is only about as much current as the parking lights take, the battery is not overloaded, the charging generator does not require readjustment, and the normal operation of the car is not impaired. The machine measures only 5 x 5 $\frac{1}{4}$ x 9 $\frac{1}{2}$ inches and is easily installed. A special model for sound trucks is available. This draws 4 $\frac{1}{2}$ amperes from the storage battery and supplies 225 volts at 75 milliamperes. *Carter Genemotor Corporation.*

79. MILES MICROPHONES

Microphones, dynamic speaker units, trumpets, baffles, horns, interphone systems, and public address amplifiers, in interesting variety and number, are described in this new catalog and supplemental data sheets, which should be kept on file by every Service Man or technician who works with public address amplifiers and associated apparatus. The "Connectophone" system for private communication within an office, department or building is of special interest, as it offers Service Men a new field of business. *Miles Reproducer Company, Inc.*

80. FLECHTHEIM CONDENSERS

A wide variety of fixed condensers, ranging from tiny midgets, the size of postage stamps, to heavy transmitting units a foot high, are described and illustrated in the latest Flechtheim catalog. This is very useful for reference in design and service work, as it gives the mechanical dimensions and electrical characteristics of all models in minute detail. *A. M. Flechtheim & Co.*

RADIO-CRAFT 75-80
Readers Bureau
96-98 Park Place, New York, N. Y.

Please send me free of charge the following booklets indicated by numbers in the published list above:

No.

Name

Address

City..... State.....

(Please check the following)

I am
(1) Service Man (2) Experimenter
(3) Dealer (4) Jobber
(5) Radio Engineer
(6) Licensed Amateur

(7) Professional or Amateur Set Builder
This coupon will not be honored unless you check off your classification above.

New

[15 to 550 Meters]
Improved Super-Heterodyne Circuit

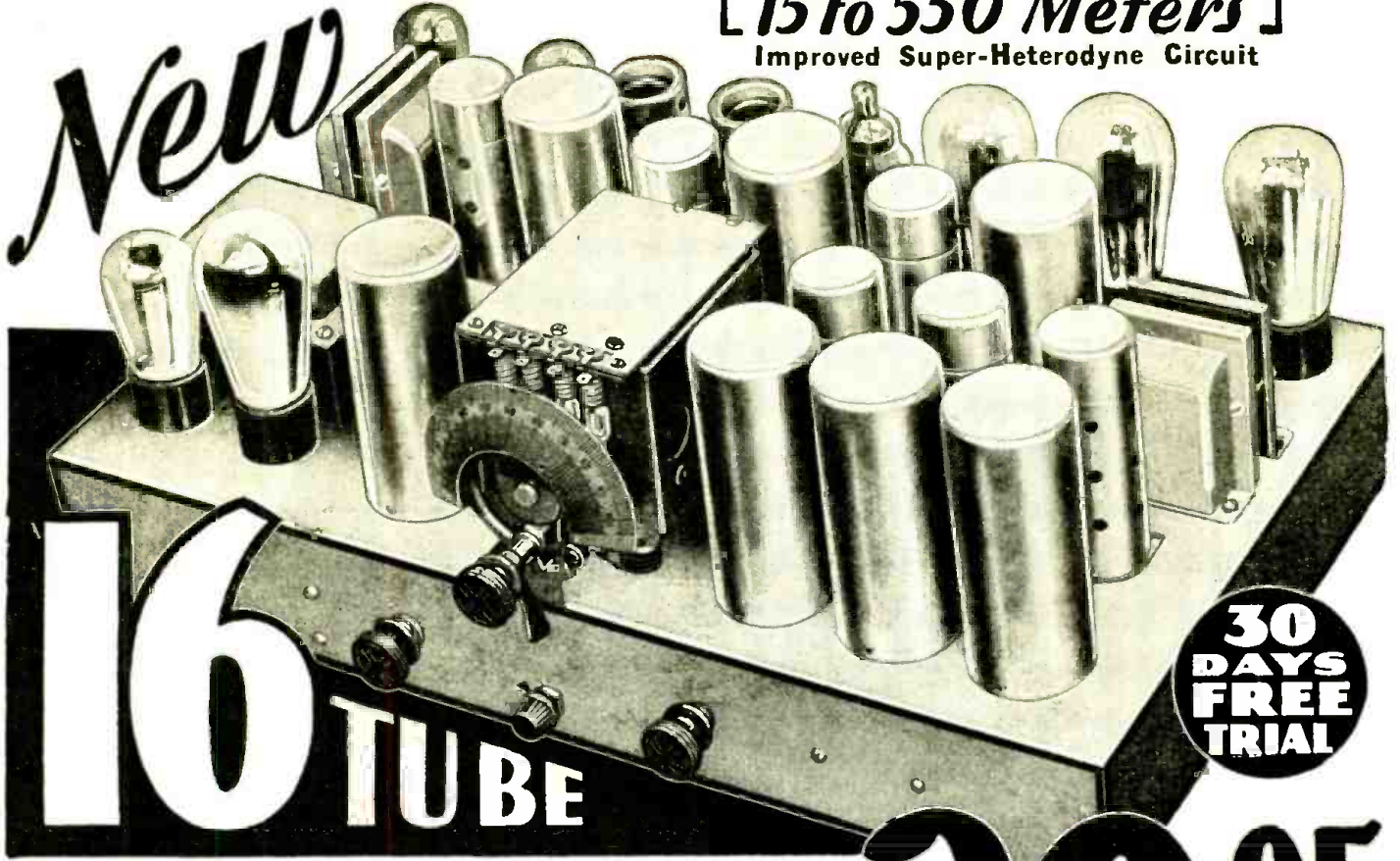

16 TUBE

30 DAYS FREE TRIAL

ALL-WAVE RADIO Only \$39.95

Completely Assembled with Large Dual Speakers

World Wide Reception may be yours when you own this sensational new Midwest 16-tube ALL-WAVE set with a tuning range of 15 to 550 meters. Hear standard U. S. broadcasts from coast to coast, listen to amateurs, police calls, airplane conversations, and, when conditions are favorable, short-wave broadcasts from England, Germany, France, Italy, South America, Australia, and other stations all over the world. You get the **WHOLE WORLD OF RADIO** when you get this new 16-tube Midwest—and you buy it at an amazingly low price direct from the big Midwest factory, on easy payments if you wish. No middlemen's profits to pay when you buy the Midwest way.

Don't be satisfied with less than a 16-tube Midwest ALL-WAVE set. A receiver covering only the regular broadcast waves is only half a set. Improvements in short-wave programs and receivers have made ordinary broadcast sets obsolete. The Midwest All-Wave gives you everything that's good in radio, both at home and from abroad—and all in one single dial set with perfect tone and volume control and the marvelous new color-lite tuning and STAT-OMIT.

ALL THE NEW 1933 FEATURES

- Stat-Omit Tuning Silencer
- Class "B" Amplification
- Color-Lite Wave Band Selector
- Acoustically Matched Dual Speakers . .
- Full Band Automatic Volume Control
- Dual Power, Two separate transformers
- Dual Ratio Dial
- One Complete Chassis
- Complete Scientific Shielding
- 18 Tuned Circuits, 9 in cascade
- 15 to 550 Meter Tuning Range
- Image Frequency Suppressor
- Fractional Microvolt Sensitivity
- Full-Floating Variable Condenser
- Absolutely Faithful Tone Reproduction
- Positive Tone Control
- Thermal Safety Fuse
- Duplex Duo-Diode Detection
- New Type Tubes
- Low Operating Cost

Read this letter!

"During the past week I logged the following: FYA Pontoise, France; GBK Bugby, England; HVJ Vatican City, Italy; XDA Mexico City; VK2ME Sydney, Australia; VE9GW Bowmanville, Canada; 12Ro, Rome, Italy; G5SW Chelmsford, England; CGA and VE9DR Drummondville, Canada. Also picked up many amateur and airport stations from all over United States. Numerous ship, shore and transatlantic phones from both sides and an Hawaiian Test Station came in clear and sharp. Several Spanish and German speaking stations have also been received but not yet identified. Have received every broadcast from FYA, morning and afternoon, for over a week with wonderful tone and volume. The Midwest set is certainly one to be proud of."
—Wm. S. Teter, Winterpark, Florida.



COMPLETE LINE OF CONSOLES
The big new Midwest catalog shows gorgeous line of artistic consoles in the new six-leg designs. Mail the coupon now. Get all the facts.

Don't buy any radio until you get the big new Midwest catalog. Just sign and mail the coupon or send your name and address on a postal—NOW!

Deal Direct with Factory! SAVE UP TO 50%

Midwest sweeps aside the costly old-fashioned way of selling through distributors and dealers. You buy direct from the Midwest factory with just one small profit added. You save all of the middlemen's profits.

Investigate! Mail the coupon. Get the Midwest catalog. Learn the facts about Midwest 9, 12 and 16-tube ALL-WAVE sets—also Battery sets and amazing new Radio Phonograph. Learn about our sensationally low factory prices, easy payment plan and positive guarantee of satisfaction or money back. Get a bigger, better, more powerful, better toned radio—at a positive saving of 30% to 50%!

TERMS AS LOW AS \$5 DOWN

MIDWEST RADIO CORP.
Dept. 112 (Est. 1920) CINCINNATI, OHIO

RUSH THIS COUPON FOR AMAZING FREE TRIAL OFFER AND BIG BEAUTIFUL CATALOG

Midwest Radio Corp., Dept. 112 Cincinnati, Ohio
Without obligation on my part send me your new 1933 catalog and complete details of your liberal 30-day free trial offer. This is NOT an order.

User Agents Easy EXTRA MONEY! Check here for details.

NAME.....
ADDRESS.....
TOWN.....
STATE.....



Tune the **NEW** way for World-Wide Reception with the **LINCOLN DE-LUXE-SW-33**

FOR 10 DAYS
RIGHT IN YOUR OWN HOME
AND
YOU WILL UNDERSTAND

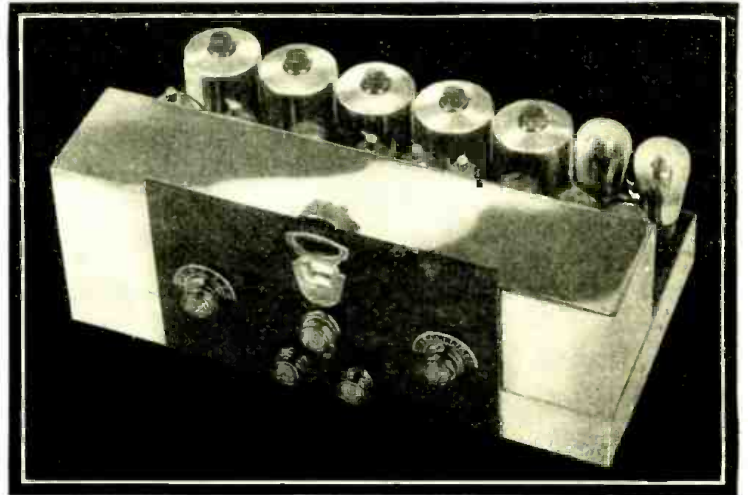

WHY—

*We Have Not Had
One Single Request for Refund on the
Lincoln DeLuxe SW-33*

- WHY — Only eight requests for refund were made in the whole previous year; which were promptly made.
- WHY — The MacMillan Expedition, Professional Experts, and super-critical fans are so enthusiastic about Lincoln performance.
- WHY — Automatic volume control, silent tuning, dual control allowing full sensitivity with low speaker volume, undistorted high amplification and a range of 15-550 meters, is giving Lincoln owners 100% satisfaction.

*You Can Buy the Lincoln DeLuxe SW-33 on a Ten Day Trial With
Money Back Guarantee*

LINCOLN
DeLuxe Receivers

LINCOLN RADIO CORPORATION
Dept. RC-11, 329 S. Wood St., Chicago, Ill.
Please send information on A.C. D.C. receivers.

Name _____
Address _____
City _____ State _____
Print name and address plainly



"Takes the Resistance Out of Radio"

Editorial Offices: 96-98 Park Place, New York, N. Y.

HUGO GERNSBACK, Editor

Vol. IV, No. 5, November, 1932.

THE DECLINE OF RADIO SETS

An Editorial by HUGO GERNSBACK

THE radio industry is apt to place the blame for its declining business during the last two years on the depression, when, as a matter of fact, all of the falling off in business is not necessarily traceable to the depression alone. A large portion of the reduction in business must necessarily be laid right at the doors of the manufacturers themselves who, with a detached disregard of the ultimate consumer, have done everything in their power to discourage not only the customer, but the Service Men too.

The radio industry could very well take a leaf out of the book of the automobile manufacturers and learn that the worn-out slogan "The Customer be Damned" is no longer up-to-date and applicable. Years ago, when something went wrong with your car, you had to crawl underneath it to make necessary adjustments. Nowadays, automobile manufacturers build cars in such a way that when trouble arises it can be rectified with the least possible amount of effort. Can you imagine an automobile manufacturer putting spark plugs in a position so inaccessible that it is well-nigh impossible to reach them? Of course you cannot.

Yet, radio set manufacturers do just this very thing. Have you ever tried to replace a rear tube in some of our present-day receivers? It just can't be done. You must take out the chassis and do a lot of fussing until you can reach the tube. In other words, the radio manufacturer makes it as hard as possible for you. All he seems to be interested in is to sell his set. There are, to be sure, notable exceptions to the rule, but a large percentage of set manufacturers don't seem to give a whoop and blithely go on their old way.

Then, when it comes to tube replacements in general, there certainly is nothing more preposterous under the sun. Have you tried to replace a tube in a set these days—and who hasn't? Unless you are a magician or are equipped with X-Ray eyes; or unless you have Einsteinian faculties that enable you to look around corners, it is next to impossible to put a tube in a socket these days.

There are four, five, six, and seven prongs on the present tubes, and there is, of course, no guiding device that tells you how to place the tube; and unless you can see the holes of the socket, replacement becomes a real job. If all the billions of curse words, invectives and other interesting language were placed on top of each other, and if the inventor of the modern tube socket were placed underneath this pile, humanity would no doubt benefit a great deal.

Of course, the whole thing started originally because the radio manufacturers, out for the last fraction of a cent, did away with the guide tube and socket pin because the guide tube was expensive, and still more expensive to rivet into place. Naturally, they did away with it, forgetting the ultimate consumer in the process. So now we have one of the most intolerable conditions that was ever foisted on a long-suffering humanity. Eventually, the tube and set manufacturers will get together again and do something about it, so you can place a tube in a socket without running a temperature, and without cursing tube and set manufacturers. I have, however, little hope that it will happen during this century.

Exactly the same sort of argument can be advanced for the pilot lamp. Someone originally had a good idea when he thought of placing a pilot lamp on a dial for illumination

purposes so that the customer may see where the set is tuned. All well and good if a first-class lamp of a good American make were used. Unfortunately, manufacturers, dealers, and supply houses, in order to buy as cheaply as possible put—the curse of American business—the cheapest kind of Japanese bulb into the pilot-lamp socket. It is well-known that there are no worse bulbs on the face of the globe than the Japanese. The only thing that can be said for them is that they light up when they are new and that they are very cheap, but everyone knows that they do not last. So that when the poor Service Man comes around the set literally has to be ripped apart and the chassis taken out, nine times out of ten, in order to get that confounded little bulb into place.

It would seem that some bright office boy in the average radio plant could, within five minutes, develop a set where the pilot lamp was really accessible; but in this instance, as well, I have little hope that it will be done during the present century.

I mentioned in a former editorial the fact that many set owners would dearly like to attach one or two extra loudspeakers to their present set. It would certainly help the popularity of the receiver if it could be done. Few manufacturers, however, so far, have seen fit to spend the extra two cents, or fraction of two cents, to equip their sets with extra binding posts in order to make it possible for their customers to attach an extra loudspeaker.

Yet, nothing is done about it, and I do not look forward to any sudden change in this respect either; so if you wish to attach an extra loudspeaker to a modern set, you must cut into the wiring and take a chance of short circuiting apparatus, and putting the set out of commission.

Another thing which the average layman cannot seem to understand is why a set manufacturer (and this covers 90 percent of them) insists on leaving the back of the set exposed. From the most expensive console down to the cheapest midget, all the backs are exposed. For technical reasons it would, of course, not be possible to board up the back because it is necessary, with modern loudspeakers, to have plenty of air through the back as well as through the front. Yet, the manufacturer goes to great pains to put a nice piece of cloth in front of the loudspeaker which protects the speaker from dust and also improves the looks of the set itself.

A bright, five-year-old boy would come to the conclusion that what is good for the front of the speaker must, by the same logic, be good for the back of the set, and so he could, without overworking his mentality, suggest a cheap wooden frame over which the same sort of cloth is stretched and the entire frame fastened with four screws to the back of the set. This would, of course, take care of the set nicely because the several ounces of dust that collect during a year in the inside of the receiver could not get in, and the condensers and other parts would give maximum service; but the bright, young, five-year-old would, of course, not know that the set manufacturer is loathe to spend the extra three or four cents that it would cost for such a cover frame.

Once upon a time a leading automobile manufacturer had a good slogan, which I may paraphrase as follows:

"Whenever worse radio sets are made, the radio industry will make them."

HOW TO BUILD THE "DIODE-TRIODE"

By R. D. WASHBURNE and
FRANCIS R. HARRIS

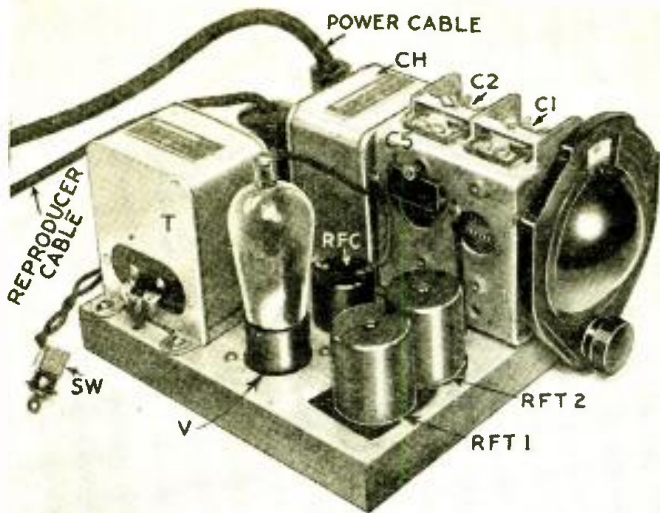

Fig. A
Front view of the receiver. Refer all lettering to the schematic diagram.

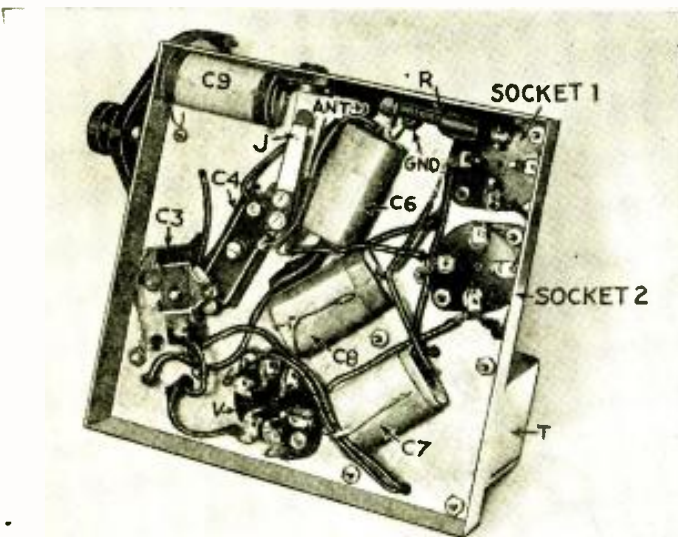

Fig. B
Under-chassis view. The simplicity is self-evident.

IN THIS article the authors present a complete description of a novel receiver design incorporating a modern tube in an "old style" circuit. No one who has owned a reflex receiver of earlier design will dispute the statement that its tone quality was unsurpassed; the present modern development retains this highly desirable characteristic and removes the "bug-a-boos" which made previous designs impractical. Furthermore, three distinct operations are secured in one tube; even the best of previous reflex receiver designs required at least one tube as the detector and another as the combination R.F. and A.F. amplifier. The "secret" lies in the use of a type 85 tube. The characteristics of this heater-type unit, which operates at a filament potential of 6.3 V., make it convenient to use a storage battery, drycells, or 110 V. A.C. or D.C., for the filament, and a "B" battery or "B" eliminator for the plate supply. Controlled regeneration permits the operator to locate stations by the "zero beat" method, where the receiver is to be operated at a point remote from most transmitters. "Locals" operate a loudspeaker with excellent volume; distant stations are easily tuned-in with good volume on either the loudspeaker or headphones.

BACK in 1908 a patent covering the two-element "Fleming Valve" or half-wave "diode" type of tube made its appearance, and close on its heels, there followed another for the three-element "DeForest audion" or "triode," then, in 1914 similar protection was granted to Schloemilch and Von Bronk who had conceived the idea of making the triode function simultaneously both as an R.F. and an A.F. amplifier. In lieu of a tube, however, a crystal detector was used as the half-wave rectifier required to complete this "reflex" receiver combination. An early type of perfected reflex receiver is illustrated in Fig. 1.

In this circuit arrangement, only a single tuned R.F. transformer is required, R.F.T. 1; the second R.F. transformer is an untuned unit, R.F.T. 2; the device V may be any standard type of three-element tube; the potentiometer P is a type of volume and sensitivity control which, in earlier days, was quite popular (particularly, with "B" battery manufacturers!). Resistor R is the usual rheostat.

Things stood at about this stage of development for a great number of years; then, interest in the reflex circuit rapidly waned. Within the next few months, however, consideration of this novel circuit combination will be given considerable impetus, due to the advent of numerous tubes of various characteristics.

One of the most interesting of these is the new "duodiode-triode" which is now available in two models, the "55," requiring a filament potential 2.5 V. and current 1. A., and the "85," requiring a filament potential of 6.3 V. and current of 0.3A (both models are discussed in the September, 1932 issue of RADIO-CRAFT). Fleming's "diode" and DeForest's "triode" are here combined in one envelope.

Thus, it becomes convenient to develop an interesting reflex circuit wherein the actions of the dual R.F. and A.F. triode amplifier and the half-wave diode rectifier may be combined in one tube, as shown in Fig. 2.

The action in reflex receivers is clearly outlined in Radio Service Data Sheet No. 7, "Day-Fan Five 5044," December, 1929, pg. 250. However, for the benefit of those who have forgotten their reflex theory, and those to whom the new combination may present a too-difficult problem, let us follow a signal right through from antenna to reproducer.

Theory of Operation

The signal picked up by the antenna is applied, through coupling condenser C4, to the first resonant circuit which is composed of condenser C1 and the winding S of R.F. transformer R.F.T.1; the effect of C3 in the branch circuit may, for the moment, be neglected. The signal thus tuned-in develops a voltage across coil P of the same unit and, through coupling condenser C5, is applied to the control-grid of the diode-triode, V; the impedance of R.F.C. to signals within the broadcast band is so high that leakage through it may be considered negligible.

The R.F. signal, now amplified by the triode portion of tube V, passes through primary P of R.F. transformer R.F.T.2, and thence, via the leakage path (due to the shielding) afforded by choke Ch. to ground (the chassis). At the same time, a small portion of this R.F. energy is fed back, via feedback condenser C3, to the control-grid circuit, thus producing regeneration. This combination of two tuned circuits and regeneration results in fairly good selectivity.

The next step is to rectify the signal and this is accomplished by applying the desired signal, as selected by the second tuned

REFLEX RECEIVER

Reflex Receivers are especially warranted in these days when one-tube sets are in demand. In building the reflex here, the authors have used the latest tube available—the 85.

circuit C2 and the secondary S of the second R.F. transformer, R.F.T.2, to the rectifier portion of the type 85 tube. (The rectifier portion of the 85 tube is provided with two plates for full-wave operation. However, it is necessary to obtain the greatest possible output from the circuit, since it is limited to one tube and consequently half-wave operation, which doubles the output voltage, is more to be desired. For this reason, either plate alone may be used or, as shown in the schematic circuit of Fig. 2, the two may be connected together.)

The rectified signal develops a voltage across the primary of the A.F. transformer, T, which induces a secondary potential, of increased voltage, in the series-connected windings S1 S2. This A.F. potential, applied to the control-grid of tube V, is amplified by the triode section of the 85. The amplified potential which is then developed across the output choke Ch. is applied to the reproducer system through coupling condenser C6.

Description of Receiver

Although this receiver is capable of very satisfactory "room-volume" reproduction of local programs, it is designed primarily as a headphone type of receiver. Consequently, the jack J is so connected that when the headphones are plugged into circuit, the reproducer is disconnected.

Socket 1 is provided for the power supply, which connects as follows: G, "B+" 180 V.; P, "B-"; F-, "A-"; F+, "A+." Socket 2 is the receptacle for a plug which is wired to the reproducer as follows: G, magnetic reproducer, or dynamic reproducer output transformer primary plate connection; P, magnetic reproducer, or dynamic reproducer output transformer primary "B-" connection; F-, field coil (if used); F+, field coil (if used).

As shown in dotted lines, in Fig. 2, a variable condenser, C 3A, may be connected into circuit as an auxiliary control of volume and sensitivity; it is shown in position in the cover illustration. However, the writers prefer to dispense with this unit, the resulting arrangement being as shown in the photographic illustration, Fig. A.

"Juggle" with condensers C3 and C4 until even regeneration is obtained over the entire broadcast band, for a given size of antenna. Align the tuned circuits by adjusting condensers C1A

and C2A, which are mounted on the condenser gang, while listening to a weak signal.

An extremely important factor in obtaining correct operation from this reflex circuit is the "phase relation" of the R.F. transformers, as contrasted with the A.F. transformers which, in this respect, are quite unaffected by a reversal of connections. For instance, if the connections to primary P of R.F.T.1 are reverse connected, it will be impossible to obtain even regeneration, and instead the circuit will break into oscillation at the shorter wavelengths.

This little set was designed to operate directly from a storage battery, dry battery, or 6.3-volt transformer filament supply and a "B" battery or "B" eliminator plate supply. Its operation under these conditions have been so interesting that there is now contemplated a much more high-power design, to be fully A.C. operated.

List of Parts

- One U.S.L. two-gang variable condenser, 350 mmf. per section, with trimmers, C1, C2;
- One Gen-Win "antenna" small-space shielded screen-grid R.F. transformer, for 350 mmf. condenser, R.F.T.1;
- One Gen-Win "interstage" small-space shielded screen-grid R.F. transformer, for 350 mmf. condenser, R.F.T.2;
- One Hammarlund type EC-35 equalizing condenser, 2 to 35 mmf. (If C3A is not used, substitute as C3 a type EC-80 unit, 20 to 80 mmf.), C3;
- One Hammarlund type MC-35 S midget condenser, 4 to 35 mmf. C3A;
- One XL-Variodenser type G-5, 500 mmf. max., C4;
- One Polymet mica-insulated grid condenser, 30 mmf., C5;
- Three Concourse 1. mf., 300 V., uncased paper condenser, C6, C7, C8;
- One Concourse 25 mf., 35 V., tubular dry electrolytic condenser, C9;
- One Lynch metallized resistor, 2,500 ohms, R;
- One Silver-Marshall R.F. choke, 85 mhy., R.F.C.;
- One Kenyon type BC 3000 A.F. output impedance, 250 hy., Ch.;
- One Kenyon type B 12, 4:1 A.F. transformer (push-pull input type), T;
- One off-on switch, Sw.;
- One B.M.S. closed, single-circuit jack, J;
- One twin-post terminal strip marked Ant. and Gnd.;
- One Kurz-Kasch dial, with transparent scale;
- One Kurz-Kasch knob, for C3;
- One Blau aluminum chassis, 7 1/2 x 7 1/2 x 1 in. high;
- One 3/8-in. to 1/4-in. shaft adapter;
- Two UX-type wafer sockets, 1, 2;
- One 6-prong wafer-type socket, for V;
- One Eveready Raytheon type 85 duodiode-triode, V.

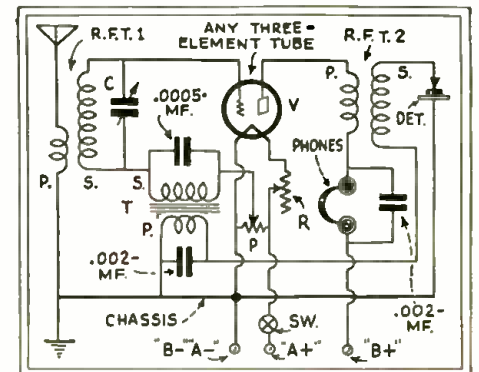
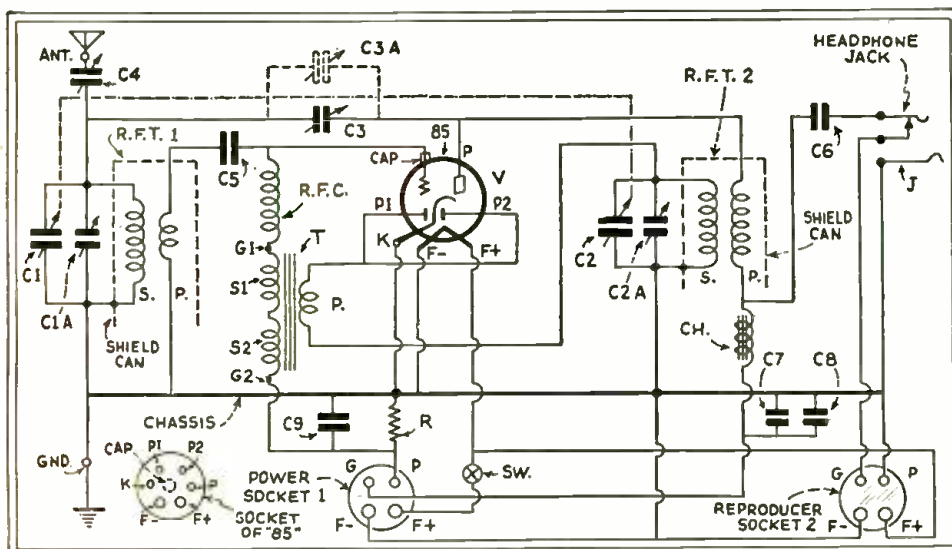

Fig. 1, Above
Schematic of the simplified reflex.

Fig. 2, Left
Complete schematic circuit of the "Diode-Triode" reflex receiver. Refer to the photographs for the placement of the parts.

THE LATEST RADIO EQUIPMENT

THE "MULTIDAPTER"

BECAUSE the avalanche of new tubes has caused thousands of set analyzers and tube checkers to become obsolete, the Radio City Products Co. has produced the very novel "Multidapter" pictured below.

In a single unit it incorporates all the adapters suitable for testing the new five-, six-, and seven-prong tubes and provides terminals for connecting all the elements in any manner suitable for a particular test. The adapter itself fits in to all standard sockets, but for special cases a cord and plug arrangement may be secured. Indeed, it is an extremely timely addition to the service field.

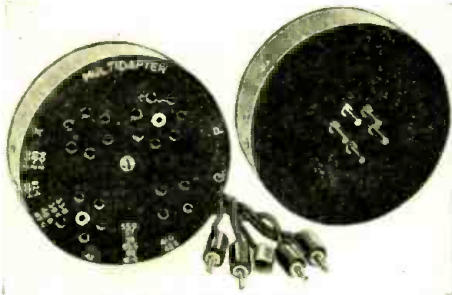

The Radio City Multidapter.

NEW BEEDE METER

SELLING for less than one dollar, the new Beede meter illustrated below meets the crying demand of Service Men for a low-priced meter of good quality. They are provided in all ranges, and with the aid of multipliers, may be easily converted into voltmeters. In fact, they may be considered the "small brother" of the larger instrument described in the October issue. Voltmeter types are also available.

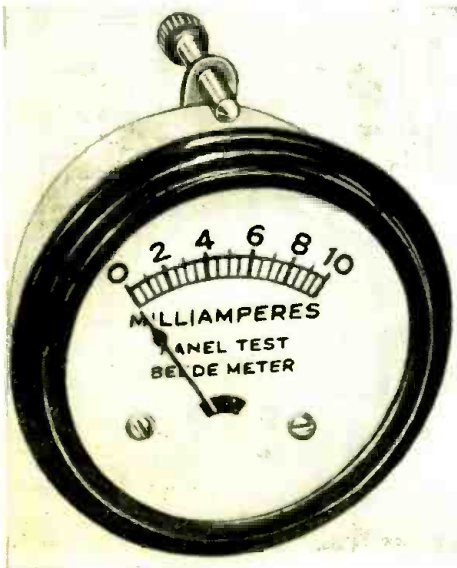

The new small Beede meter.

FRANKLIN TUBE CHECKER

ILLUSTRATED below is the new FRC (Franklin Radio Corp.) tube checker, model H-33. This checker has some very desirable features such as testing facilities for all of the new four-, five-, six-, and seven-prong tubes including the new 83, 85, and 89 without the use of adapters. It checks the plate current of both plates



The Franklin tube checker.

of the '80, 82, 83, 895; the pentode; and the 866 mercury-vapor rectifier.

When testing tubes in this tester, D.C. voltages are applied to the tube at the rated values determined by the manufacturer, thus eliminating the necessity of guess work. A table of normal readings is included in the cover of the unit for easy reference.

An extremely valuable feature is the inclusion of voltage terminals and resistance continuity facilities on the left side of the tester as shown. With these provisions, resistors up to 2 megs. may be measured. An additional feature is the fact that the sockets may be removed to facilitate changes for new tubes.

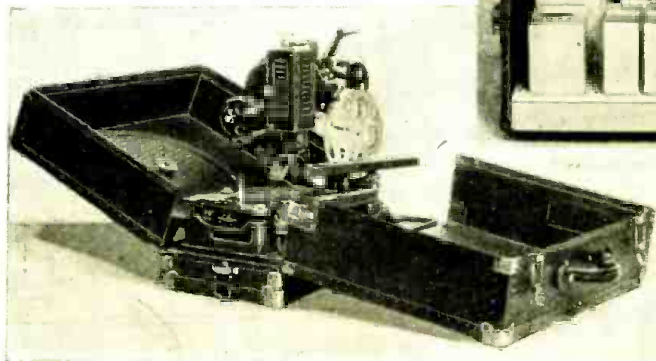

GALVANOMETER SUSPENSION

A PRODUCT of the G-M Laboratories, the galvanometer suspension, illustrated at the left, facilitates the making of galvanometer measurements in locations where extreme vibrations make precision galvanometer work the exception rather than the rule.

Mechanical vibrations travel, in phase, down the tripod support and cancel. Oil pan and vanes further effect the damping.



16 MM. SOUND SYSTEM

PICTURED below is the new Western Electric portable sound-on-disc, 16 mm. motion picture projector known as the type MPS-16 and MPD-16 which are designed to project pictures from 16 mm. film at 24 frames per second in synchronism with the reproduction of sound from a 33 1/3 R.P.M. disc record.

The MPS-16 system includes one projector-turntable unit only for simplex operation, while the MPD-16 system has two such systems for duplex operation. All necessary apparatus, exclusive of the screen, is contained in two carrying cases, one of which houses the complete projector-turntable unit and the other an amplifier-loudspeaker unit. A 7.5 x 6.5-foot picture is obtained with a 2-inch lens with a 45-foot throw.



Left, the carrying case housing the projector; above, the case containing the amplifier and speaker in the W. E. portable sound system.

PORTABLE POWER UNIT

OLD timers will remember the days, some ten years ago, when a portable receiver was really not portable unless an auxiliary crew of six men were required to carry the batteries. Those who were fortunate enough to possess a car, could not afford the space required for additional passengers—the batteries took up so much room.

All this is now changed. A.C. operated receivers dominate almost every home in the metropolitan areas, and with the addition of the portable power unit pictured below, they are soon to envelope the portable field as well.

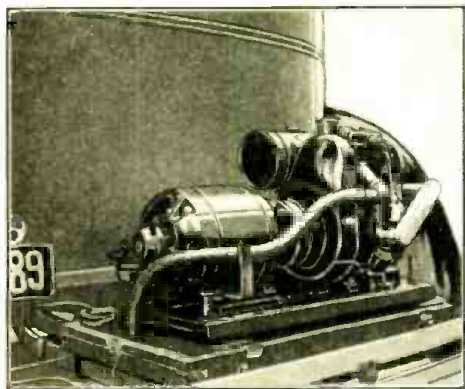

New portable power supply unit.

As may be seen by referring to the photograph, the unit is so designed that it may easily be carried on the trunk rack provided at the rear of the car—out of the way of any and all passengers that may be in the car.

Operated from a separate gasoline engine, the device is designed especially for public address work where a relatively large power consumption is required, although it may be used for ordinary radio receiver operation in conjunction with phonograph equipment.

Because of its unique power supply, the device operates independently of the car battery.

WANTED!

WE are interested in publishing unusual experiences of our readers in radio reception.

If you get unusual DX reception, or if you live in one of those unusual locations where you can pull in almost any station, we would like to have your letters for publication.

We are also very much interested in receiving letters from those who receive foreign broadcasts, particularly trans-oceanic reception. All such letters published, will be paid for at regular space rates.

EDITOR.

NEW "MIDGET" SET

MIDGET receivers have so long dominated the radio field in this country (about two years—which is long for the radio industry) that it is difficult to conceive of any radio manufacturer now producing receivers without at least one midget in his line. Let's see what England says.

Illustrated below is a new model English radio set exhibited at the recent radio exhibition held at Olympia, England. Note, in particular, the diminutive size of the tubes, coils, wire, etc., by comparing them with the men in the foreground.

Don't worry, though—it's only a model!

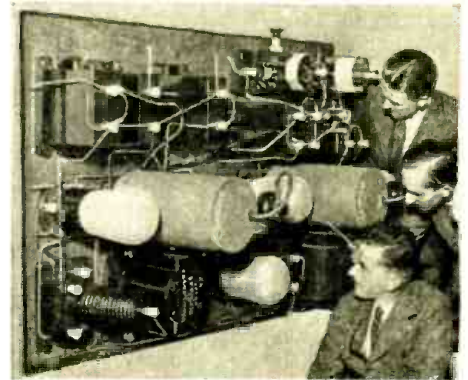

The "midget" receiver by—.

NEW GERMAN DEVELOPMENTS

● BEGINNING with this issue of RADIO-CRAFT, the editors will attempt to bring before its readers the latest devices and advances used in foreign countries. It is hoped that by this procedure, readers will gain a better insight into the advances made in foreign countries, and thus will be better fitted to judge American standards. This month, we start with Germany.

Pictured below is a new receiver manufactured by Telefunken, of Germany. Now, this receiver has many good points which may well be incorporated in American sets.

First, the under-chassis view, shown to the right of the set, is so constructed as to make servicing a relatively easy matter. This, of course, is in direct contradiction to American standards.

Another feature is the fact that the bleeder resistor is made in one long strip consisting of individual components mechanically held together. In the event that one part of the strip goes—it does not become necessary to replace the entire unit. And, each and every part of the strip has its value marked on it, so to avoid useless looking through "parts lists" in order to find the value of the defective unit. Parts lists are provided for replacement work, of course.

The tuning dial is especially unique. The extreme right-hand photograph shows it. Besides having a velvet vernier dial, all stations are marked on the dial to prevent confusion when tuning for stations.

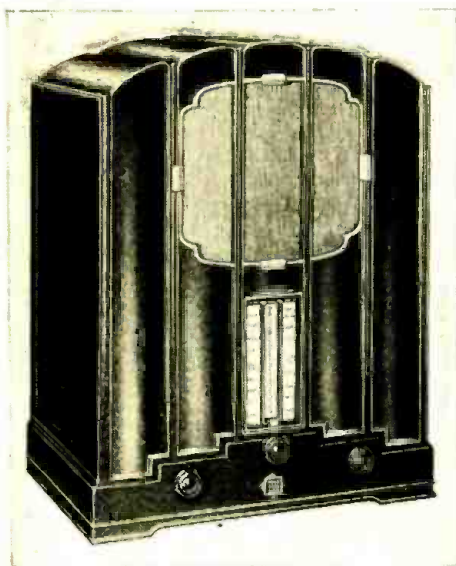

New Telefunken receiver.

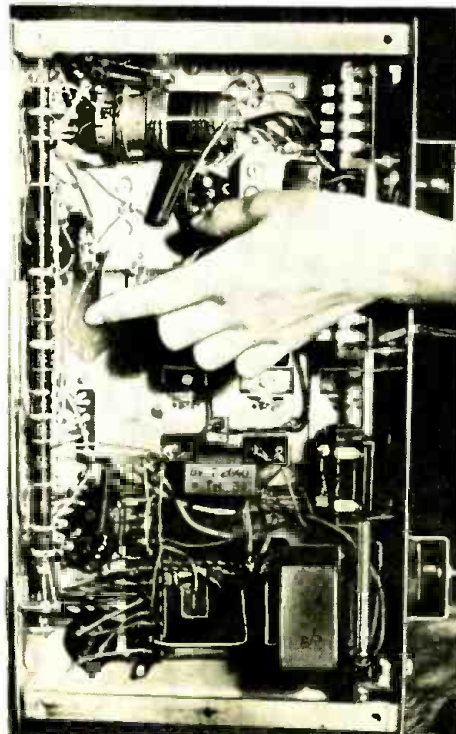

Under-chassis view of the receiver.

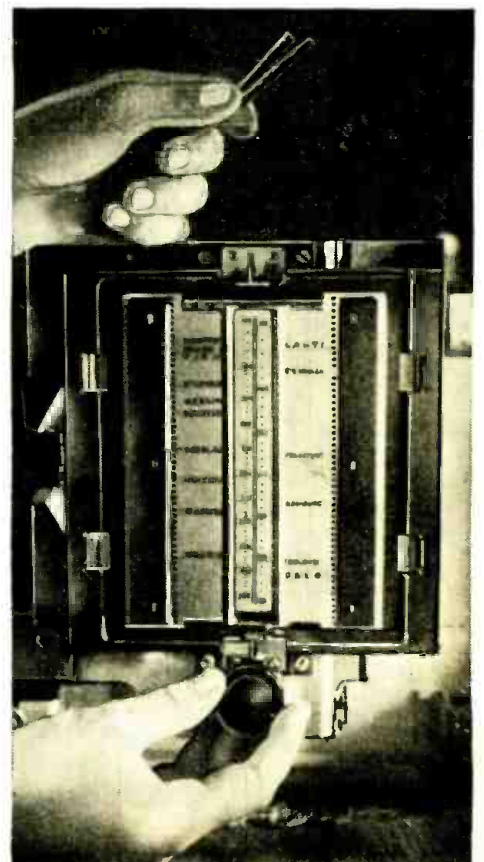

Here's a tuning dial that's not a toy.

ELECTROMAGNETIC MUSIC

An interesting description of the manner in which a new musical instrument produces a wide range of frequencies without the use of vacuum tubes.

By E. E. KASSEL*

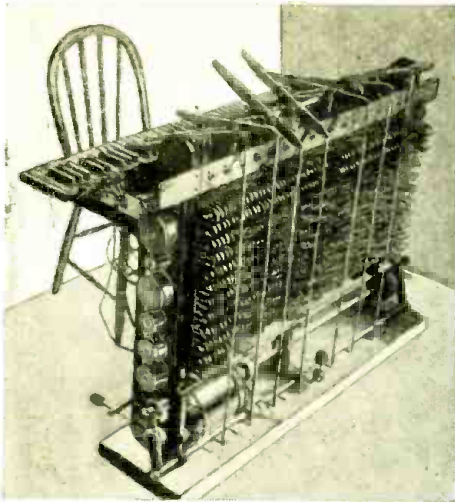

Fig. A
Photograph showing the "works" in the larger model instrument.



Fig. B
The size of the "Gnome" may easily be estimated from this picture.

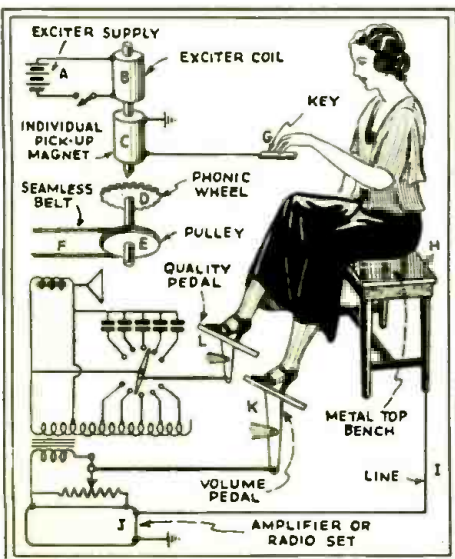

Fig. 1
A sketch illustrating the principle of operation of the "Gnome."

MANY types of electric organs utilizing vacuum tubes and curious circuit arrangements have been built, operated, and described in this and other publications. These instruments have all had some inherent faults such as poor tuning, limited pitches, limited qualities, cumbersome equipment, high cost of production, inability to collaborate with an orchestra because two or more instruments cannot be successfully synchronized, and many other bad features which have so far hindered progress in this line.

It is the belief of Ivan Eremeeff, Russian physicist with laboratories in this country, that the above mentioned difficulties may be obviated by employing a combination of phonic wheels and an electromagnetic system to generate tones. Such a system would not be subjected to the eccentricities of systems employing vacuum tubes. As a result of this contention, two types of musical instruments have been developed and are illustrated in Figs. A and B.

The larger instrument, shown in Fig. A, is a synthetic type, operating on principles involving the synthesis of fundamental frequencies with harmonic, sub-harmonic, multiple, and fractional frequencies, for the production of musical tones of predetermined pitch, volume, and tone quality.

In addition to the numerous different tone qualities, various tonal effects are produced with the aid of a novel keying system. As shown in the photographs and in the sketch of Fig. 1, the keyboards consist of stationary metal keys which are sensitive to the touch of the fingers, the greater the pressure, the better the conductivity, and the greater the volume of the output. The pitches of the keys are in accordance with standardized piano keyboards, and therefore, anyone skilled in the art of playing a piano or organ can shortly adapt himself to the operation of these instruments.

Theory of Operation

The many different tonal effects created by the various keying touches resemble certain known musical sounds as well as many new and heretofore unknown musical effects. The effect of plucking on a stringed instrument; a piano effect, produced with the aid of a tone-diminishing device; an organ effect, in which the tones are carried out as long as the hands remain on the keyboard; a staccato effect;

a light flute effect; a slur effect, and others are among the many tonal variations available with a keyboard of this type.

The source of the tones in these instruments is a series of multi-toothed phonic wheels of the magneto type, and their cooperative adjustable iron core magnets as illustrated in Fig. 1.

Referring to the figure, a pulley E, driven by a belt F, rotates a tooth wheel D, placed directly under a pickup magnet C, which is excited by an exciter coil B. As a result of the changing magnetic flux, an EMF is generated which is directly proportional to the speed of the wheel, the number of teeth, and the size of the pickup magnet C. The pitch or frequencies of the voltage generated depend, of course, upon the speed and number of teeth in the wheel D. The phonic wheels placed upon shafts which revolve by pulleys of different diameters and at different predetermined speeds, according to the frequencies of the pitches of a musical scale, collaborate with their magnets for producing tones of different pitches. These tones are then fed into an ordinary radio amplifier, and then, of course, to the loud-speaker.

The smaller instrument has been called a "Gnome" and works on the same basic principles as employed in the larger type of instrument described above. However, while the large type obtains tone peculiarities by the accurate synthesis of different frequencies at different intensities, the "Gnome" produces tone quality with the aid of a dial wave-alteration control, in which wave forms are modified by the selective connection of the output circuit to different taps of a transformer, or by a system of condensers which are adjusted by a dial.

In both cases, however, the performer is seated upon a bench which has a metal top to which the circuit of the instrument is connected, the body of the performer acting as a conductor to the metal of the keys, the sensitivity of the touch of the fingers determining the effect of tones, as previously described.

A rather novel feature introduced by these instruments is the new method of music writing, including the accurate scientific delineation of curves representing wave forms, in place of ordinary notes and symbols as used in ordinary music writing today. These new methods correctly indicate pitch, by frequency numbers; vol-

(Continued on page 297)

*Mechanical and Photoelectric Instrument Laboratories.

A CHURCH SOUND SYSTEM

By KARL DOBESCH, Berlin



View showing the band microphone in front of altar.

ST. STEPHAN'S CATHEDRAL OF VIENNA, a marvel of Gothic architecture, was handicapped by poor acoustics. Its magnitude made it virtually impossible for the preacher to be heard throughout the nave, inasmuch as the high-towered curved ceiling, through its multiple echoes, drowned the words. In the presentation of ecclesiastical music, the distance of 100 meters (330 feet) between the main altar and the big organ manifested itself unpleasantly by the elapse of 1/3 of a second which the sound requires to overbridge the distance, thus causing considerable difficulty in the way of timing the music and the choirs.

In order to do away with these deficiencies, the chapter of the cathedral tried to bring about improved acoustic conditions by appropriate measures. The task in question was fulfilled completely. After numerous acoustic experiments which were undertaken, it was found that an installation of eleven electro-dynamic loudspeakers was necessary. The placing of the speakers was made, keeping in mind that there should be an equal amount of sound energy in the northern and southern transepts and in the side aisles.

Several loudspeakers had to be especially shielded to suppress echoing. In installing the loudspeakers, not only was the attainment of the best possible acoustic qualities a main factor, but it was also necessary to set them in the least conspicuous places, so as not to disturb the architectural beauty of the interior in any way. Apart from the small dimensions of the loudspeakers, this requisite was fulfilled by a coat of stone-gray paint. Built in the ornaments and carvings of the pillars, in the altars and in the chairs of the choir, they are practically invisible in the dim light of the cathedral.

(Continued on page 298)

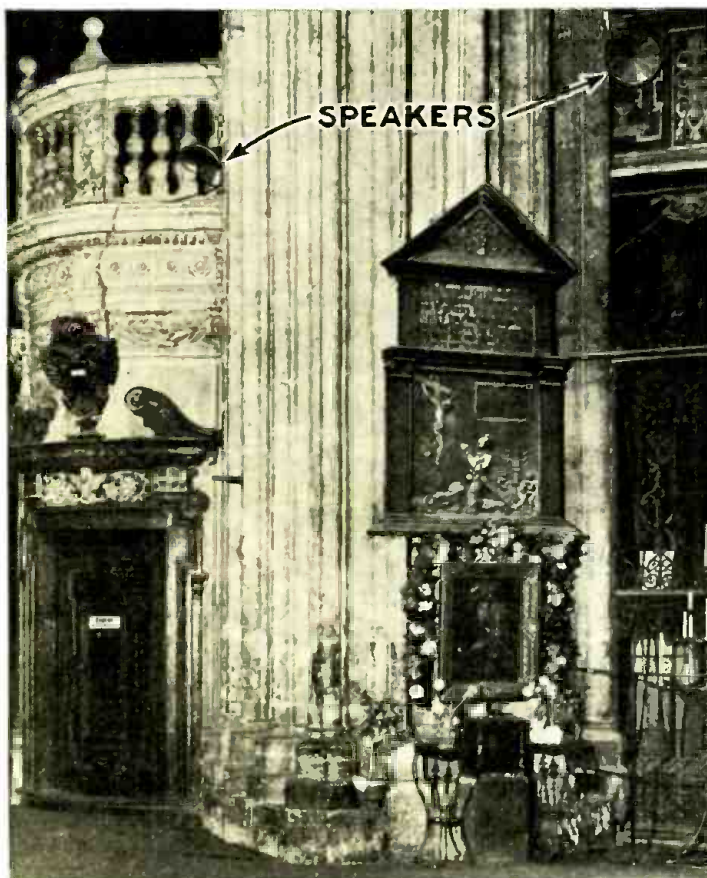

Note the placement of two speakers, one located over a painting of Maria Poetsch.

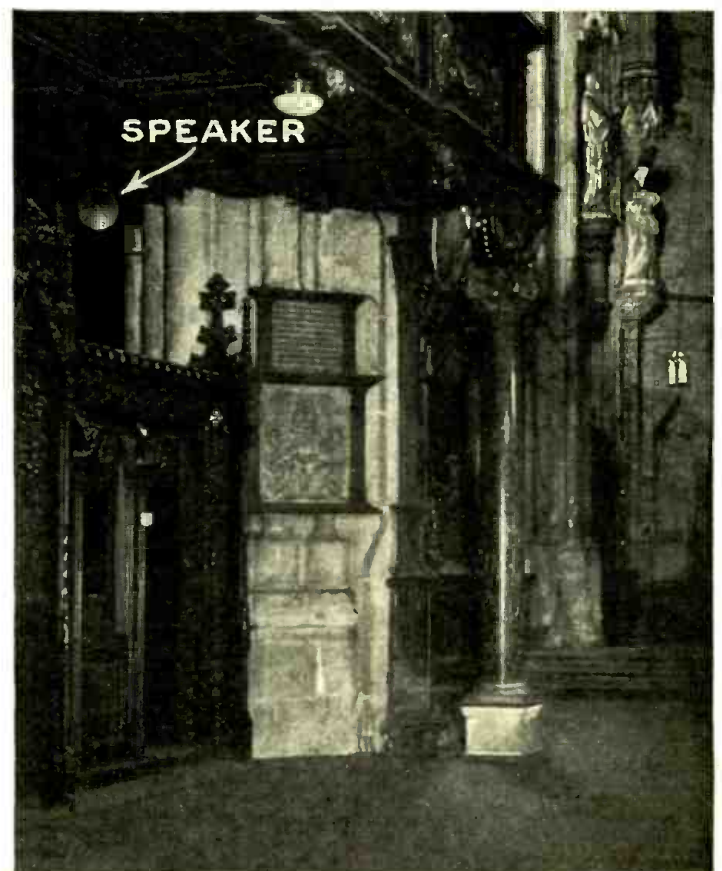

Another speaker placed at the southern part of the church, near a monument of Emperor Frederick III.

THE VELOCITY MICROPHONE

All of the microphones developed and used in the past utilize, for their action, the pressure variations of the impressed sound. In this latest development, the action of the microphone depends upon the velocity of the impinging wave.

By J. P. TAYLOR*

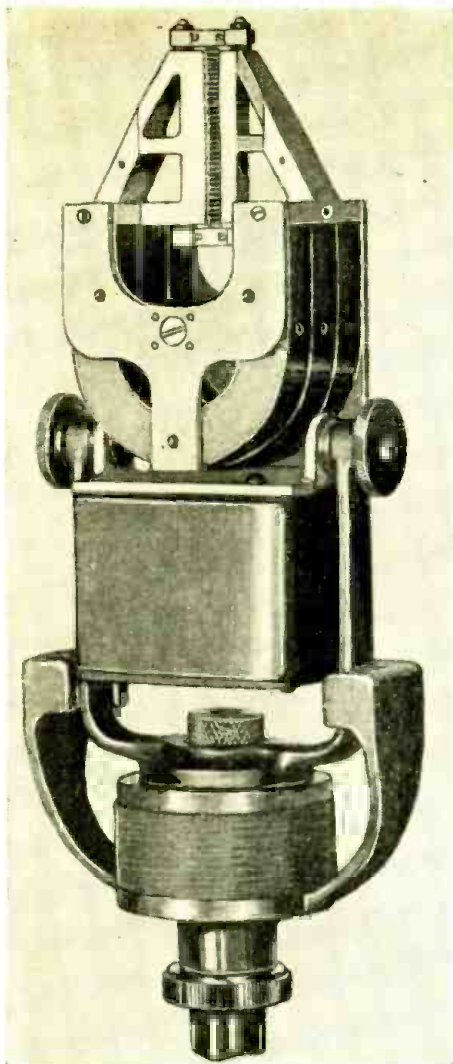

Fig. A
An excellent photograph illustrating the assembly of the Velocity Microphone. The three permanent magnets support a magnetic frame between which the corrugated, duraluminum strip vibrates, as shown above at the top.



Fig. B
An illustration of the flexibility possible in placing the artists with the new microphone. In the older types, it was necessary for all the artists to face the front of the microphone, but with the Velocity microphone, the artists may be anywhere around it.

FROM the early days of broadcasting, the studio microphone has presented the hardest problem engineers have had to meet in their constant efforts to improve broadcast fidelity. Early carbon types were unreliable and of poor quality. They were improved upon—but were never entirely satisfactory because of their high background noise and susceptibility to blasting. Meanwhile, speech input and transmitting equipment capable of reproducing faithfully the range of frequencies from 30 to 10,000 cycles had been developed. A microphone of equal range was imperative.

The condenser microphone was the answer. Transmitting with fair fidelity the entire range, it presented a real advance and soon became an accepted standard. Recently other types of microphones have been introduced. These have had about the same characteristics as the best condenser microphone but have had an advantage (under certain circumstances) in that they did not require a closely linked amplifier.

Despite the 30-to-10,000-cycle range of the condenser and other recent types of microphones, they did not satisfy the more discriminating engineers. The frequency curves by which they were judged

were fairly flat—but they were made by the actuator method. In this method of calibration, the pressure of the sound wave is simulated by a vibrating rod exerting a mechanical pressure on the diaphragm of the microphone. Engineers were openly doubtful of the veracity of this method—they thought they could detect in the reproduced signal whistles and lips which could be due only to the unnatural accentuation of certain frequencies. They decided to check it by the Rayleigh disc method.

A pure sound wave of known frequency and amplitude is generated by the Rayleigh disc. Since this is essentially a sound wave in free space, it makes possible very accurate measurements of microphone response. As these engineers expected, these measurements showed all available microphones to have various peaks and dips. Having proved this, they had no difficulty in determining the reason.

All the microphones used up to this time employed a diaphragm which offered a relatively large and impeding surface to the passage of the sound waves. These waves were reflected by this surface and hence the pressure on the diaphragm was

(Continued on page 299)

*Transmitter Sales Engineer, R. C. A. Victor Co., Inc.

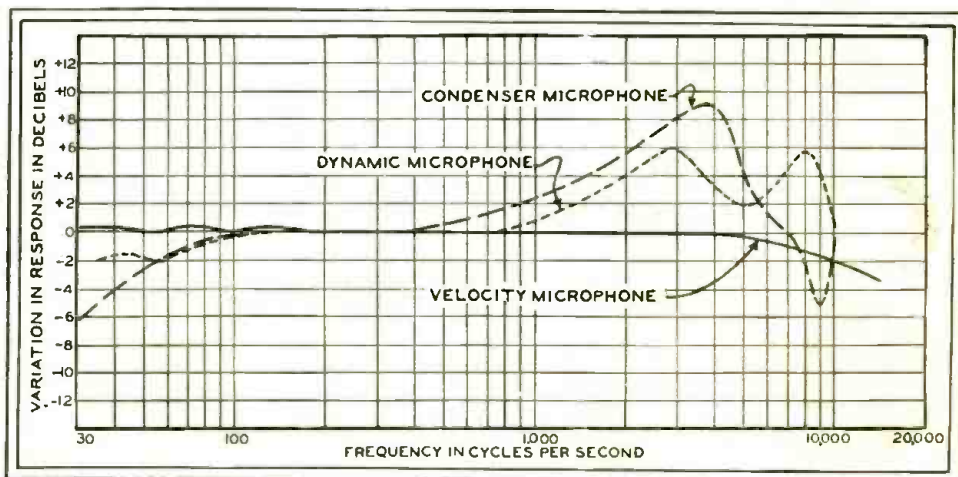
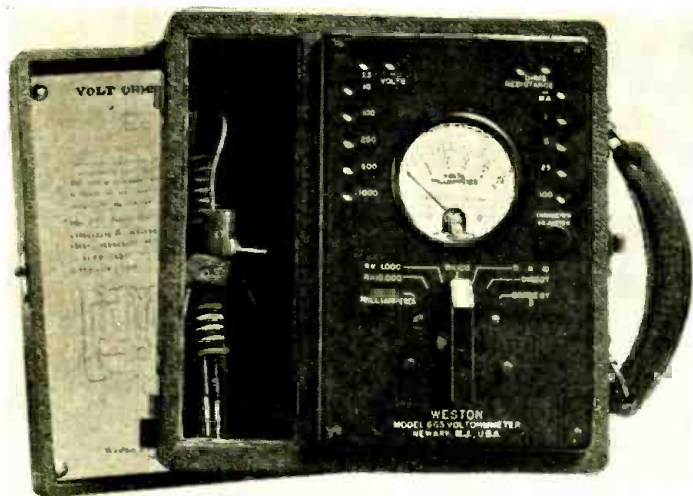

Fig. 1
Curves comparing the condenser, dynamic and velocity microphones.

ANNOUNCING THE WESTON 663

VOLT-OHMMETER

By L. VAN DER MEL



The new model 663 volt-ohmmeter.

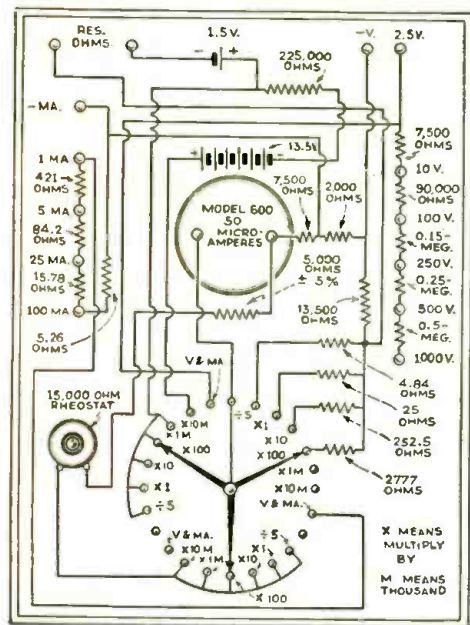

Schematic circuit of the new model 663.

THE Model No. 663 volt-ohmmeter illustrated here has been designed to answer the demand for an ohmmeter capable of measuring both very low and very high resistances. The volt-

age and current ranges have been added to make this instrument as universal in its application as possible. This instrument should really be considered as a volt-ohmmeter, the current ranges simply adding to the usefulness of the device.

The circuit (shown here) has been built onto a molded black bakelite panel of the same style and dimensions as the panel used in the Model No. 660 described in the September 1932 issue of this magazine. In appearance, the 663 is exactly similar to the 660; the panel is complete as a unit, no parts being mounted in the case itself.

The meter used in the 663 is a Model 600 microammeter, having a full-scale sensitivity of 50 microamperes. This sensitivity is required for the higher resistance ranges. A very small diameter tubular pointer on the meter with a knife edge tip is also used. This is the same pointer as is now being used in the Model 301 instrument in the 660 Analyzer. An

etched scale, showing 0-1,000 ohms above, and 0.25-5-10 volts and milliamperes below the arcs, is supplied.

Energy for the ohmmeter ranges is supplied from self-contained batteries. Three Burgess No. 5360 or Eveready No. 781, and one Burgess No. 2 Unit Cell or Eveready No. 950 Unit Cell are required. These batteries fit into clips mounted on the rear of the panel where they are accessible by removing the panel from the case.

A twenty-four position, one-deck switch is mounted under the panel in the same manner as the switch is mounted in the 660 panel. This switch is arranged to operate through eight positions only, giving seven ohmmeter ranges and one position both for "Volts and Milliamperes." Battery-voltage compensation is obtained by the same arrangement as used in the Model 660. The control knob is located in the same relative position and appropriately designated "ohmmeter adjuster."

Seven tip jacks are used on the upper left hand side of the panel for the six voltage ranges. These jacks are of the same style as used on the Model 660 and are connected to the meter only when the switch is in the "Volts-Milliamperes" position. All voltage ranges are on the basis of 1,000 ohms per volt—a recognized voltmeter sensitivity for all classes of vacuum-tubes popular in other fields.

(Continued on page 297)

THE CRYSTAL MICROPHONE

ON the opposite page is illustrated and described the "Velocity Microphone," which shows promise of invading the sound field to no small extent. Previous issues of this publication have carried descriptions of the crystal loudspeaker, and mention was made of a crystal microphone. At the left is illustrated a new type of unit utilizing the same principles as the crystal speaker—the crystal microphone.

Housed in a heavy, black, metallic shell, as illustrated in the upper part of the photograph, it represents a very decided advance in microphone technique. A view illustrating the component parts is shown in the lower part of the photograph.

Construction

The assembly of the microphone is very simple. The two plates of the crystal are mounted, sandwich-like, near the terminal end as shown. One edge of the crystals is cemented to the shell, leaving the other end (the crystal is wedge-shaped) free to

vibrate. The drive rod is attached to the free end.

The diaphragm is cone shaped, and its apex is rigidly attached to the drive rod mentioned above. Contrary to the conventional diaphragms used in microphones, the type made use of in this construction is of impregnated, soft cardboard. In this manner, metallic rattles are done away with; critical annealing and stretching is entirely eliminated; and the diaphragm may be dismantled for inspection without any fear of it not functioning properly after it is put together again.

Using the Microphone

The advantage of the unit is the fact that it may be connected directly into the grid and filament of a tube without any transformers of any sort. The volume control for the unit may be connected directly across the microphone terminals.

Of course, if the leads from the microphone to the amplifier are to be very long, a transformer between the "mike" and the line is recommended.



Above is a completely assembled, and below a dismantled view of the crystal microphone.

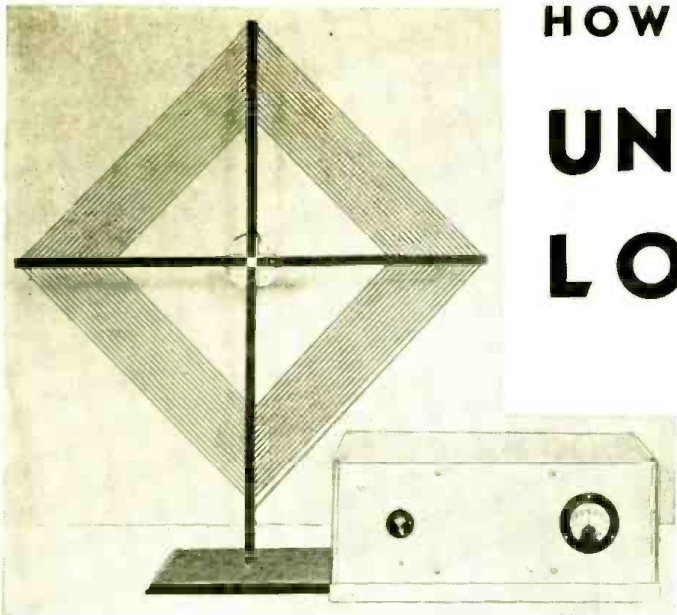

Fig. A

HOW TO BUILD AND OPERATE A UNI-DIRECTIONAL LOOP ADAPTER

FOR THE BROADCAST FAN

By C. W. PALMER

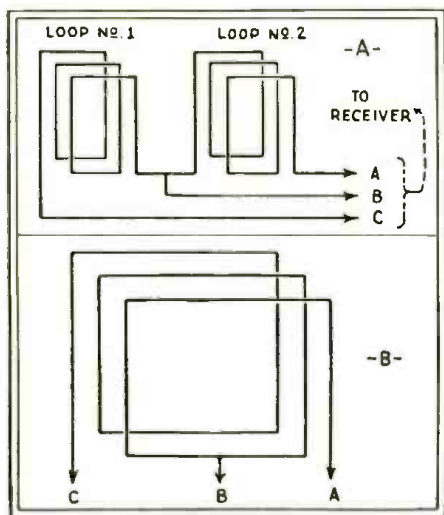

Fig. 1

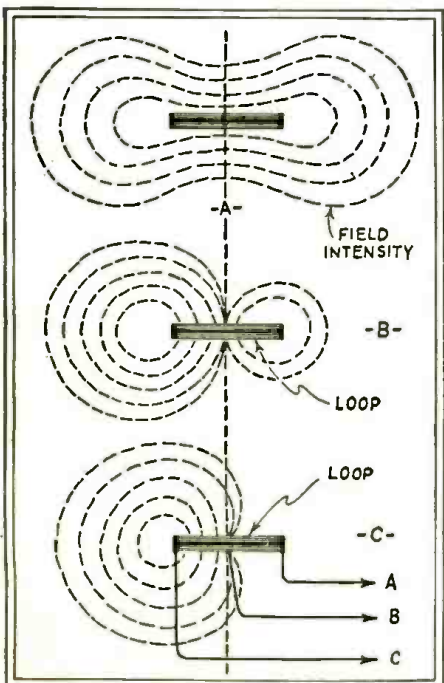

Fig. 3

SOME time ago, the Aeronautical Branch of the U. S. Department of Commerce issued a bulletin in which an advanced type of direction finder was described. In this direction finder a single, small loop-aerial is employed. It gives the direction of the transmitting station and also the sense of deviation of the line of flight of the airplane from this direction.

With these facts in mind, it occurred to the writer that such a unit could be used to advantage for broadcast reception, when it is desired to employ a loop. In the first place, no special input circuit for the broadcast set is necessary as the loop unit is merely connected to the aerial terminal of the broadcast receiver; and, in addition, the best point of reception for the loop for a particular station is indicated by *visual* means, through the use of a zero-center pointer type of milliammeter.

So much for the advantages of the loop; let us now consider the method of operation of the device. Suppose that we have two loops connected in series as shown in Fig. 1. Terminal B is the mid-point of the two loops and connects directly to the aerial post on the receiver. The ground post of the set is connected to A, terminal C being open. Under these conditions only loop No. 2 is in operation. If, now, terminal C is connected to the

set instead of terminal A, then loop No. 1 would be operating; the only difference being that the phase of the signal would be shifted 180 degrees—a matter of small importance.

If an automatic switch is connected in the circuit that would use loop 1 for a fraction of a second and then switch to loop 2, and if the loops were correctly connected, the net result in the loud-speaker would be the same as if only a single loop were used—except for the small break in the signal due to the time taken in switching from one loop to another. Exactly the same results may be obtained by using a single center-tapped loop as in Fig. 1B.

The *adaptation* of the single loop aerial to direction finding purposes utilizes the distorted field intensity pattern which results when the loop is not symmetrical with respect to the ground. The field intensity pattern for the reception of a transmitted wave by a loop-aerial is normally in the form of a figure-of-eight. (See Fig. 2.) Lack of symmetry of the loop-aerial with respect to ground may result in any of the distorted forms shown in Fig. 3. The cause of these changes is the *vertical effect* (in other words, the loop operating as a simple vertical aerial) and the phasing of this current with the normal loop-antenna current.

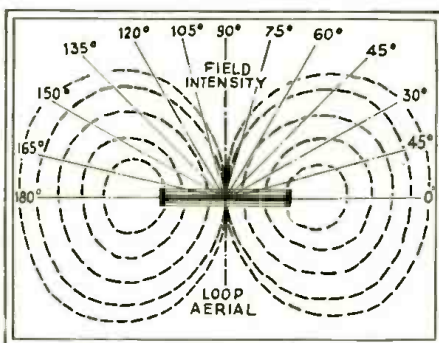

Fig. 2

Field pattern for an ordinary loop.

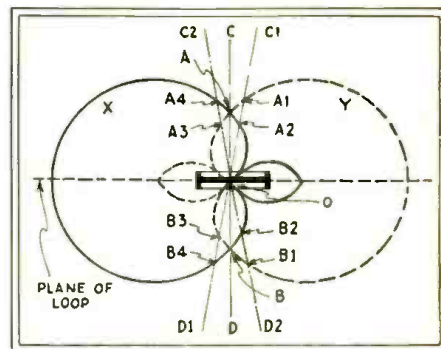

Fig. 4

Coordination of two loop patterns.

An ordinary loop cannot be used with a broadcast receiver because of ganging and additional tuning difficulties. With this circuit, the loop may easily be adapted to any receiver and has uni-directional response characteristics.

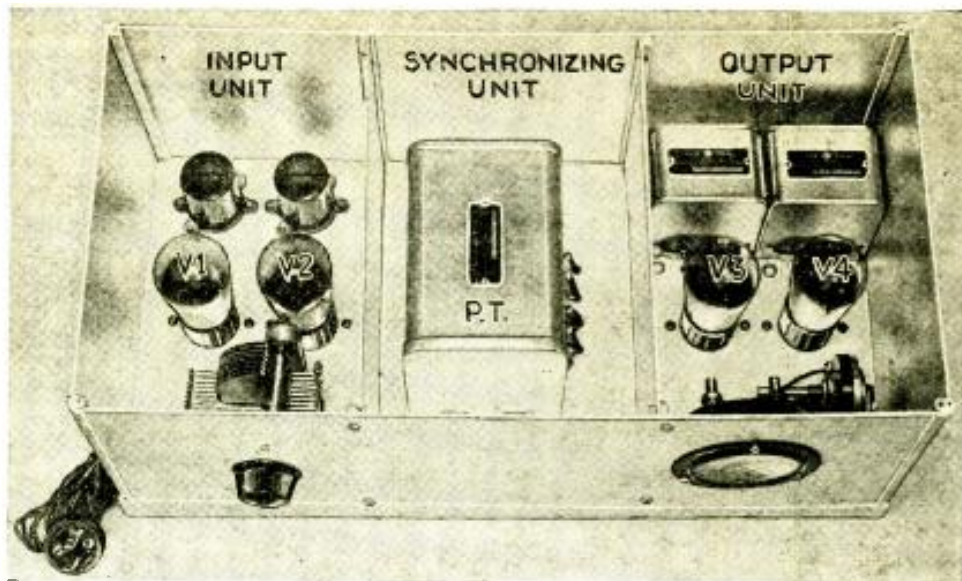

Fig. B

When the loop-aerial is tuned to resonance with the frequency of the signal being received, and the ground is displaced so that the vertical effect is present, the current due to this vertical effect is 90° out of phase with the normal current in the loop aerial. This gives the effect shown in Fig. 3A. If, however, the loop is not resonated, the current due to the vertical effect is in phase with the current in the loop and the patterns of Fig. 3B or 3C result, depending on the relative amplitude of the current due to the vertical effect and that due to the loop-aerial. It is this distorted field pattern that is utilized to provide the direct-reading indication of the direction of the transmitting station.

The Two Field Patterns

Refer to Fig. 4. This shows the co-ordination of two wave patterns on opposite sides of the center tap of the loop; that on one side being indicated by the full lines, and that on the other by the

dotted lines. The completed field pattern is then indicated by the composite diagram as shown. If the signal comes from direction C, the voltage induced in the loop from either of these patterns is equal (O to A). If, however, the signal comes from the direction C1, the voltage received on the loop for pattern Y will be equal to O-A1 which is greater than that for pattern X, namely O-A2. Suppose, now, that the signal comes from direction C2. The received voltage for pattern Y, that is, O-A3 will be much less than that for the pattern X or O-A4.

Thus it is readily seen that if some means is secured for measuring the relative intensity of these two signals, not only can the direction of the transmitting station be determined, but also the sense of deviation can be estimated.

Let us see, now, how these field patterns may be utilized for direction finding. Consider the loop pattern of Fig. 3C. Due to the vertical effect, the response of the loop to the left of the cen-

ter is greater than that at the right. This means that if a switching arrangement were provided to alternately use terminals A and C, and if at the same time a D.C. milliammeter is connected across the loudspeaker terminals, and its connections reversed in synchronism with that of the loop terminals, the D.C. milliammeter will always read in one direction. For instance, refer to Fig. 4.

A signal from C2 generates a voltage O-A4 due to pattern X and an opposite voltage O-A3 due to pattern Y; the average is some value between the two. If no switching took place, the milliammeter or galvanometer would read zero always, but if the loop terminals and the galvanometer terminals are switched in synchronism, the meter will always read to the left. The unit that does the switching is called the synchronizing unit, and that circuit in which the milliammeter or galvanometer is connected is called the output unit. The schematic circuit

(Continued on page 301)

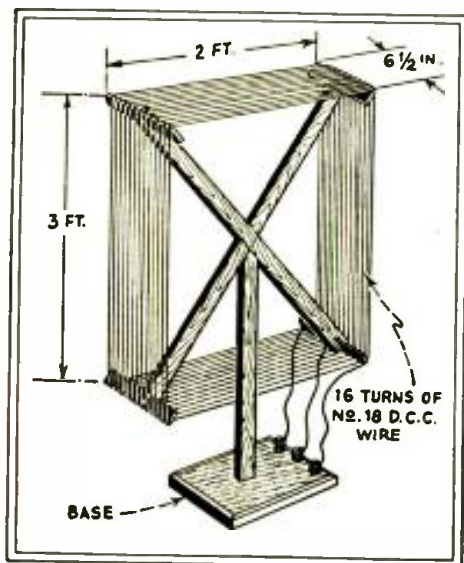

Fig. 7

Constructional details of the loop. Either a box or plane type may be used.

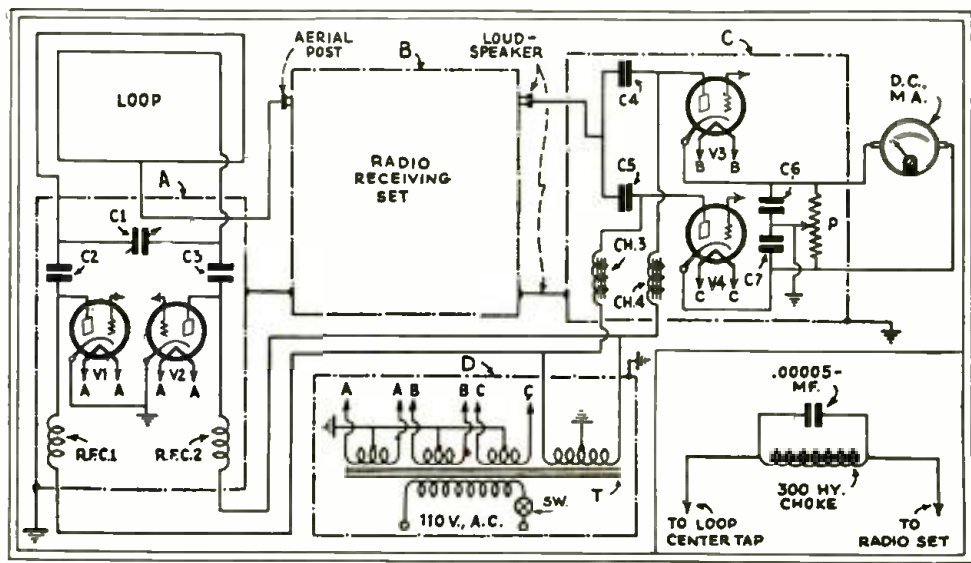

Fig. 5

Schematic circuit of the Air-Loop unit. The photographs show the location of the parts. Fig. 6, lower right The antenna filter system which is sometimes needed for proper operation.

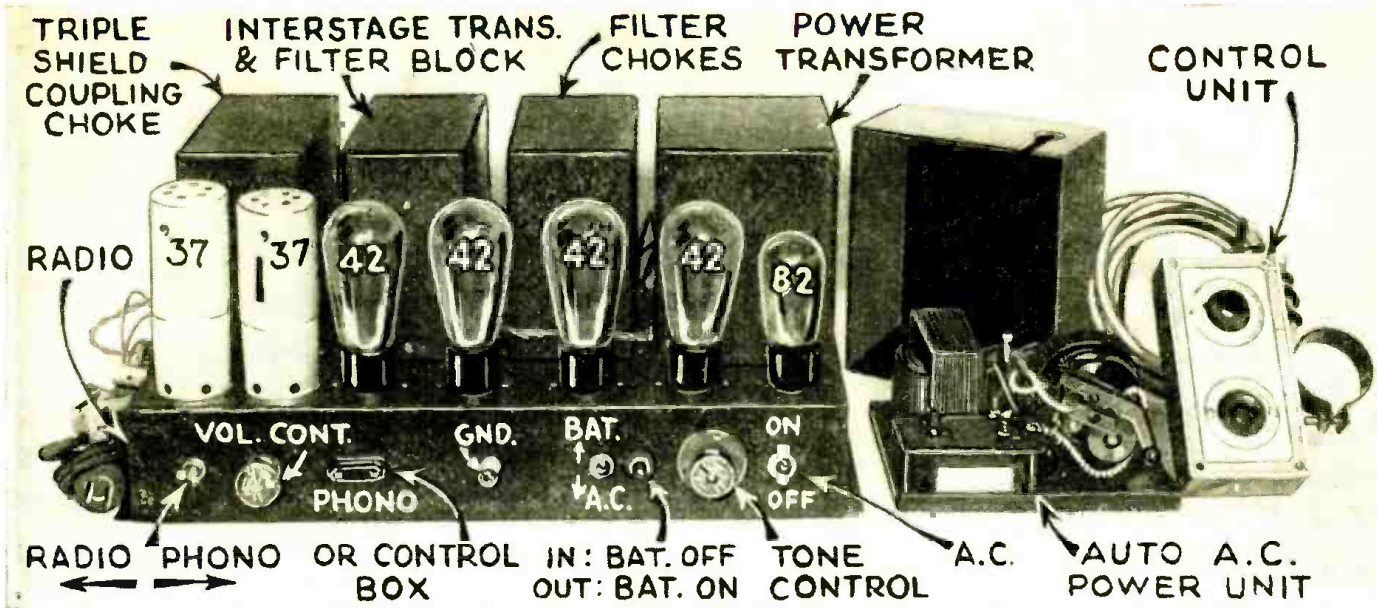

Fig. A
Left, the P.A. amplifier and right, its Auto A.C. Supply Unit. The cables for connection to the control box are also shown at the right.

A UNIVERSAL P. A. AMPLIFIER

By LEON J. LITTMANN,* B.S. in E.E., E.E.

SO many uses have been found for public-address amplifiers that it is no wonder that their use has been constantly increasing. While there are many such systems available, they are usually large, costly, and take considerable time to install. These shortcomings have prevented alert Service Men, with a small purse, from reaping the benefits which they should undeniably enjoy by renting or selling P.A. installations. RADIO-CRAFT and other publications have, in the past, outlined in detail the numerous uses to which P.A. systems may be put, and therefore any further attempts to expound them here would be superfluous. Suffice it to say, however,

that the system to be described may properly be termed a "universal amplifier," for the simple reason that it is designed for use either in an automobile or in any stationary location. The amplifier itself, illustrated at the left of Fig. A, is designed to operate directly from a 110-volt, A.C. source without any additional equipment with the exception, of course, of the microphone or turntable, and loudspeakers, and is capable of delivering 15 watts of undistorted output which is sufficient to supply an auditorium having a seating capacity of about 2,500. Obviously, with reduced volume, it may be used in small dance halls, churches, etc. When the system is to be used in a sound truck and is to be operated from

storage batteries, the unit shown at the right of Fig. A is connected between the 6-volt storage battery and the amplifier. Thus, it takes but a few moments to arrange the system for either portable or stationary work. It should be noted that the tubes may be operated directly from the car storage battery—the only purpose for this provision being to enable the use of an inexpensive 6-volt auto A.C. power unit. It is clear that such an arrangement results in increased efficiency of the entire system.

The Amplifier

The schematic circuit of this amplifier is illustrated in Fig. 1. As may be seen, it consists of two type '37 tubes in a

push-pull connection, feeding four type 42 tubes in a parallel push-pull connection. The output transformer is designed for either 3 3/4, 7 1/2, 15, or 500 ohm outputs. The usual power supply unit is provided.

The amplifier itself is equipped with four switches, SW.1, being in the primary side of the power transformer, PT; SW.2, being connected as shown, and when closed, lights the filaments of the
(Continued on page 300)

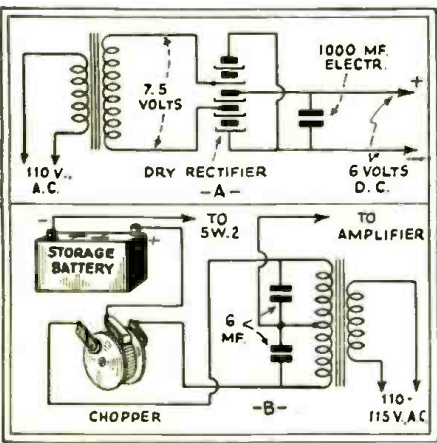
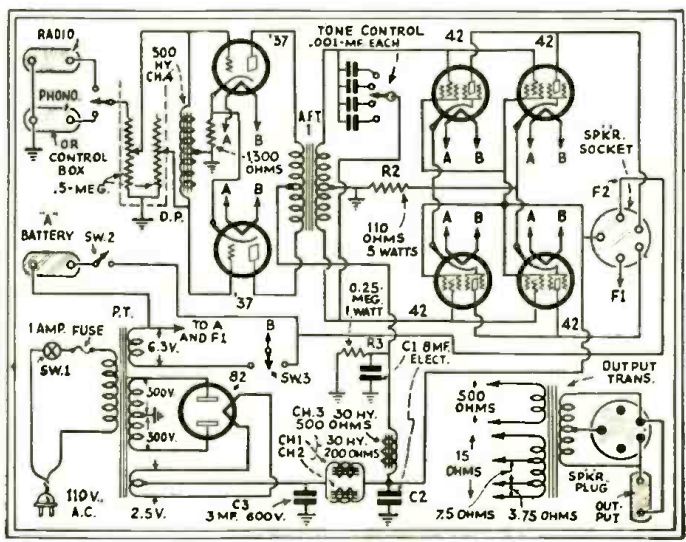

Fig. 1, right
Schematic circuit of the P.A. system and power unit. All values are shown in the diagram.
Fig. 2, above
Circuit arrangement of the power-supply unit.



THE SPECIALTY TESTER

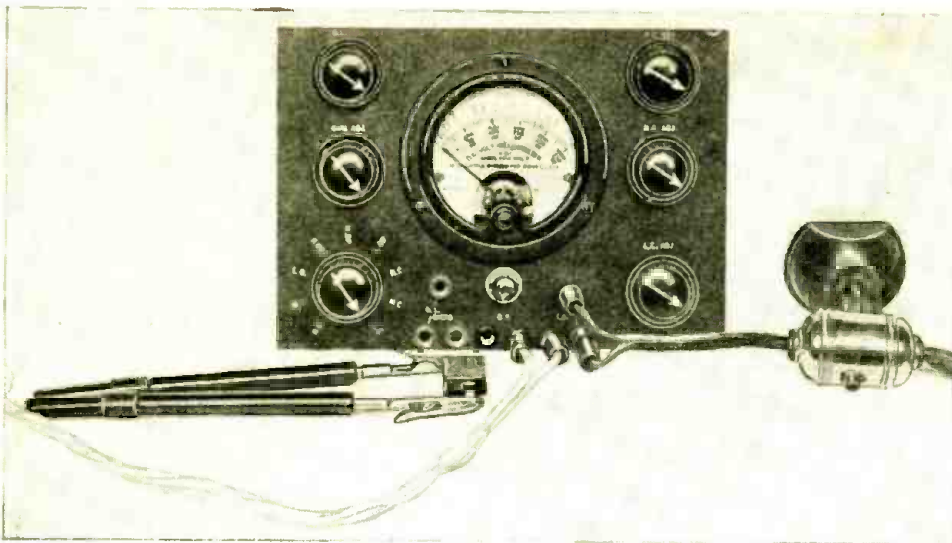

Fig. A
Front view of the "specialty tester" with its prods and line cord and switch.

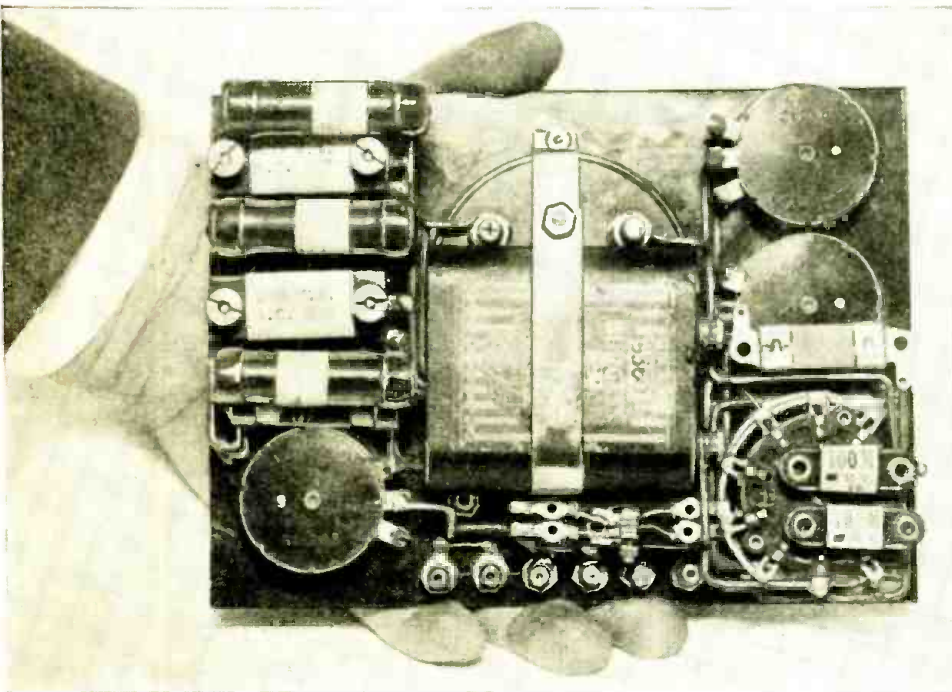

Fig. B
Rear view of the tester illustrating the placement of the parts. Note its small size.

It is the odd things in experiments and radio service work that are most annoying to the experimenter and Service Man; that is, the things that even the best of set testers do not seem to locate or provide means for locating. The odd things referred to are: capacity values, resistance, and output voltage. With this thought in mind the "specialty tester" was designed.

Compactness a Feature

The first consideration was to make the instrument compact and, therefore, portable; the final dimensions being 5 1/4 x 7 1/4 inches. The next problem was to get 33 pieces of apparatus into this space. This was finally accomplished, as may be seen from the photographs of Figs. A and B. Cost was another consideration; it

had to fall within the financial means of everyone, and yet use standard, easy-to-get parts. The parts as listed (basing the cost at recognized wholesale prices) amount to approximately \$26.00. This includes a drilled and engraved panel.

Most of the up-to-date testers incorporate some of the features of the "specialty tester"—the older types, practically none. In any case, the use of the measuring features of the specialty tester in a set analyzer is sometimes rather inconvenient.

The capacity, resistance, and output voltage ranges each have three calibrated scales, and the selection of any range is made via a four-pole, nine-throw switch. All readings on the panel are abbreviated as follows: "H.O." is high ohms (means "high resistance") range, from 0-100,000

A description of an extremely small size tester capable of measuring and testing small and large condensers and resistors. It also incorporates an A.C.-D.C. voltmeter for output measurement work.

By JACK GRAND

ohms; "M.O." is medium-ohms range of 0-10,000 ohms; "L.O." is low-ohms range of 0-1,000 ohms; "H.OP" is high-output range of 100 volts A.C.; "M.OP" is medium output range of 10 volts A.C.; "L.OP" is low-output range of 1 volt A.C.; "H.C." is the high-capacity range from 4 to 14 mf.; "M.C." is the medium-capacity range from .1- to 4mf.; "L.C." is the low-capacity range from .00025- to .05-mf. The abbreviation for the adjusters is "ADJ"; for the ohms locator "O.L."; and for output capacity "O.C."

The ohm and output-meter incorporated in the specialty tester was described in the August issue of RADIO-CRAFT. It is suggested that the constructor have that issue handy for reference.

Capacity Measurements

To obtain capacity readings from .00025 to 14 mf., three current ranges of 1., 100, and 500 ma. will be required (note the low-capacity ranges obtained with this tester).

To a number of readers analyzing capacity circuits, it would appear that resistors are unnecessary. Such is not the case.

(Continued on page 303)

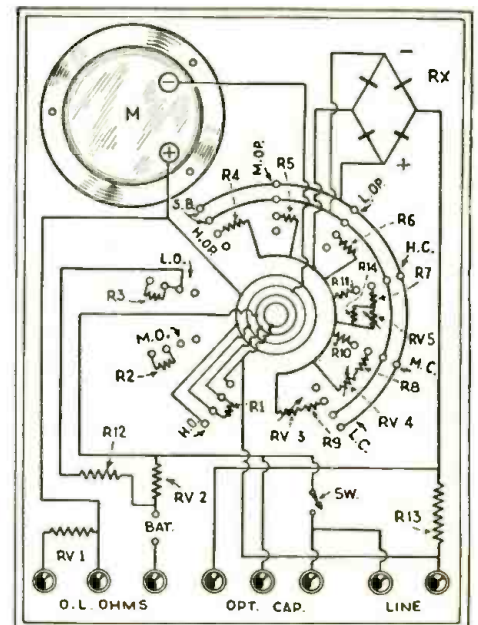
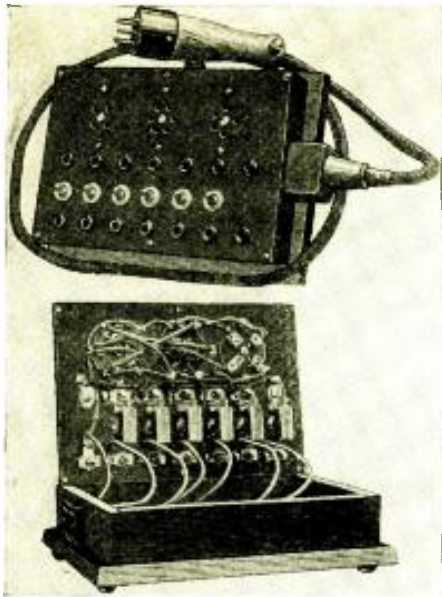

Fig. 1
Schematic circuit of the tester.



Above external, and below, internal view of the interesting analyzing adapter.

THE ever increasing number of new tubes and their varied applications make it difficult for the modern Service Man to keep abreast of the times with his testing equipment. When the type 57 and 58 tubes came out, the writer found it necessary to bring his equipment up to date.

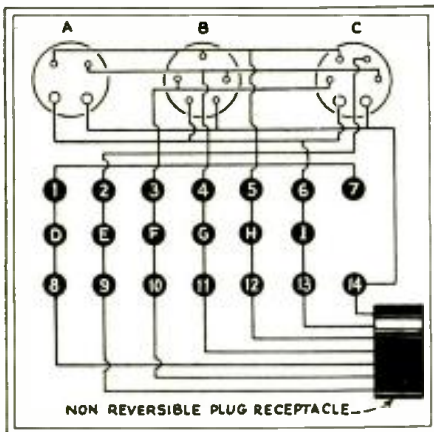

Fig. 1
Schematic circuit of the adapter.

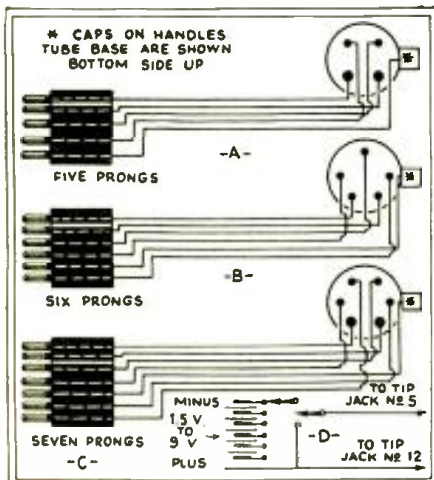

Fig. 2
Details of connections of the cables.

A UNIVERSAL ANALYZER ADAPTER

A description of a unique device capable of facilitating the measurement of all tube voltages and currents.

By HERMAN BUBLITZ

Having an A.C.-D.C. voltmeter, it is simple enough to take voltage readings right at the sockets, but when current readings are to be taken, well that's another story. In order to overcome this difficulty without spending a small fortune for a new analyzer, the adapter, herein described, was built.

It enables one to take all voltage and current readings at the tube sockets; allows all tube connections to be opened for the purpose of inserting phones for audible testing, or for the introduction of signals on the grids of tubes by means of a pickup, an oscillator or the antenna.

With the addition of one or two 4.5-volt "C" batteries, tubes may be tested for mutual conductance right from the set. They may also be tested for shorts with any continuity tester the Service Man may have.

Description of Tester

As may be seen from the photographs, the adapter consists of a box of suitable size and three cable extensions with their necessary tube bases and multiple connectors. Three separate cables were chosen in order to obviate the necessity for numerous small tube adapters, which are easily mislaid, and which have a habit of remaining in the socket of the set,

making it sometimes difficult to extract them when testing the chassis.

No exact constructional measurements are given here, since the adapter may be built to suit one's own idea. It may even be incorporated with a multi-scale voltmeter and ohmmeter in one case, constituting, in this fashion, a complete service unit.

The tip jacks recommended come in pairs, one red and one black. Thus, seven red and seven black ones are used. Mount them in the following order, referring to Fig. 1.

Jack Nos. 1, 2, 3, 4, 5, 6, and 10 are black;

Jack Nos. 7, 8, 9, 11, 12, 13 and 14 are red.

This places a black one (No. 10) in a row of red ones. Since this is the cathode, all voltages are measured from No. 10, except in the case of UX tubes. (The cathode, of course, receives the negative meter prod.) When grid-bias voltage is read, then the cathode receives the positive meter prod.

In the first row, jack No. 7 is red, the others being black. This jack is used solely for the insertion of a length of wire, about 6 to 8 inches long and containing at the free end a tube clip, to be used when testing screen-grid tubes. Mount the switches (D, E, F, G, H, and I in Fig. 1) all in one direction so the operator can readily tell whether they are open or closed. Since the tip jacks are of the insulated type, a metal panel and wafer sockets may be used.

The multi-plug extension may be fastened on either side or end of box. In constructing the cable extensions, it is advisable to use a very flexible cable with a rather loose braiding around it. As will be seen, the cable has a UX base and contains five wires, thereby permitting the testing of '22 and '32 types of tubes.

In order to construct the tube-base handles, secure three hardwood file handles having a diameter of 1 1/4 inches, saw both ends off and drill a 3/8 inch hole all the

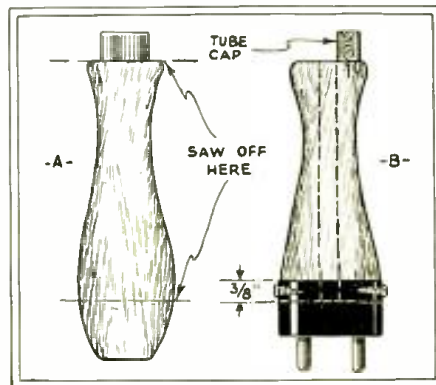

Fig. 3
Details illustrating the construction of the plug handles.

(Continued on page 304)

RADIO-CRAFT KINKS

Practical Hints From Experimenters' Private Laboratories

Prize Award

A CODE-PRACTICE ADAPTER

By Joseph X. Reilly

FINDING it necessary, recently, to build up an instrument for code practice, the idea occurred to the writer to use a dynatron oscillator as the source of the note.

A simple instrument was then constructed, illustrated in Fig. A, following the recommendations of Don Hale, in the August, 1932 issue of *Electronics* magazine, pg. 268. In the screen-grid tube circuit described by Mr. Hale, there exists not only a dynatron-oscillator action at



Fig. A
An ultra-modern code-practice set.

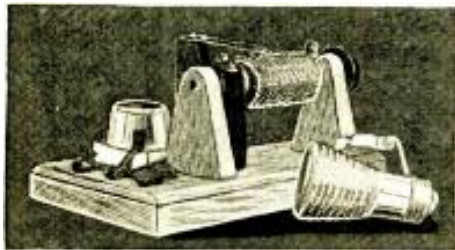

Fig. B
A power resistor for replacement work.



Fig. C
This idea is not as wet as it may appear.

\$5 for a Practical Radio Kink

As an incentive toward obtaining radio hints and experimental short-cuts, "Radio-Craft" will pay \$5.00 for the best one submitted each month. Checks will be mailed upon publication of the article.

The judges are the editors of "Radio-Craft" and their decisions are final. No unused manuscripts are returned.

Follow these simple rules: Write, or preferably type, on one side of the sheet, giving a clear description of the best radio "kink" you know of. Simple sketches in free-hand are satisfactory, as long as they explain the idea. You can send in as many kinks as you wish. Everyone is eligible for the prize except employees of "Radio-Craft" and their families.

This contest closes on the 15th of every month, by which time all the Kinks must be received for the next month.

Send all contributions to Editor, Kinks Department, c-o "Radio-Craft," 98 Park Place, New York City.

audio frequency, but also a variable-frequency characteristic; the novel feature is that the periodicity is under the direct control of a filament rheostat, R1 in Fig. 1.

The two clips on the leads of the "B" cable, shown in Fig. A, may be connected directly to a "B" battery supply of about 110 V., or they may be connected into a radio receiver at a point along the voltage divider where this voltage may be derived.

The phones constitute the A.F. resonant circuit. In some instances it may be desirable to bypass the high-voltage supply by a condenser C of about 0.1-mf. Resistor R3 establishes the maximum potential applied to the filament.

A SIMPLE LABORATORY RHEOSTAT

By F. R. Harris

DON'T know how many of you fellow experimenters have discovered the fact that the replacement elements sold for use in the bowl type of electric heater make most excellent power resistors; but for those who haven't, my tip is: give them a trial.

They have a resistance of around 18 or 20 ohms, their power dissipation capacity is very high, 600 watts or so, and properly mounted away from inflammable material one need not worry about temperature rise—they are designed to operate at red heat.

These elements are made in two general types; those with a standard screw base and those with a band of brass at each end which is fastened to terminals with screws. The former type can be mounted in porcelain sockets and wired in any desired series or parallel combina-

tion; the latter type may be mounted on a spindle supported between trunnions and variation in the resistance is then conveniently obtained by means of a contact arm, as shown in Fig. B. A knob is provided for rotating the spindle.

About the only critical dimension on the whole job is the length and setting of the swinging arm. If made too short or set incorrectly it will bind and jump upon rotating the variable element. The recommended length is $3\frac{1}{4}$ ins.; the best setting is easily determined.

The wiring diagram, Fig. 2, shows that the unit may be so connected as to use a fixed resistor only, screwed into the socket; the variable resistor alone; or both in series.

CORRECTING A REMOTE PICKUP FAULT

By A. P. D'Ambria

A RADIO broadcasting problem was recently solved when station KFKU of the University of Kansas offered two lessons in swimming—via radio.

In order to add realism to the broadcast, the director of programs conceived the idea of having the performers not only dress in appropriate costumes, but actually go through the motions in a pool during the instruction. Accordingly, the microphone was moved to the varsity swimming pool, as shown in Fig. C.

A rehearsal of the broadcast brought out the fact that conversational tones echoed and re-echoed throughout the enclosure. Various schemes to correct this condition were tried—without success. A happy solution to this problem finally was found in the use of a canvas canopy over the pool. This not only eliminated the echoing but concentrated the "splashing" and "paddling about" of the pupil and added realism to the broadcast.

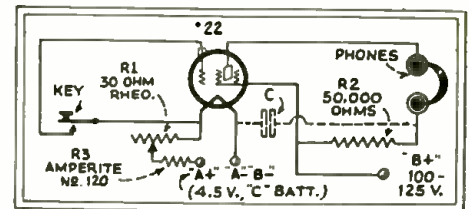

Fig. 1
Schematic circuit of the code-practice set.

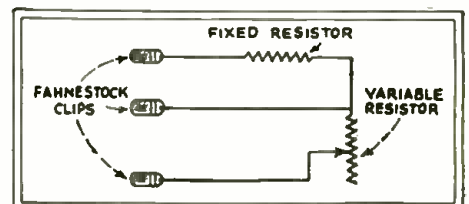
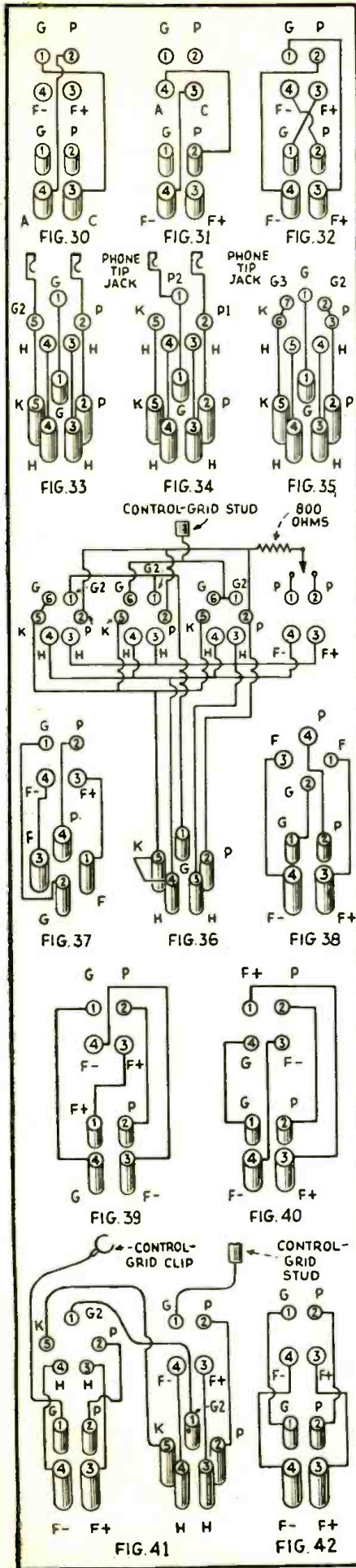

Fig. 2
Wiring diagram of the replacement power unit.

CONSTRUCTING ADAPTERS FOR

By F. L. SPRAYBERRY*



TWENTY-NINE out of one-hundred-eighteen adapters have been described in the October, 1932 issue of this magazine. The adapters as described are suitable for use with Jewell analyzers. In this issue, we complete the list of adapters for use with Jewell analyzers, and proceed, next month, with a description of adapters designed for use with Weston analyzers. Following this, will be a description of the adapters required for other standard makes of analyzers.

No. 944BRA, Fig. 30, is used with set analyzers in connection with adapter No. 944 BRB. This adapter permits the plate-current reading of the BR rectifier tube. No. 944BRA is placed in the eliminator socket while No. 944 BRB is placed in the analyzer socket. A four-prong plug, or any other plug with the proper four-prong adapter is then placed in the No. 944BRA adapter. May be used with Jewell models 117, 133, 133A, 137, 198, 199, 408, 409, 464, 577, 578, 579, 581 and 660.

No. 944BRB, Fig. 31, has been described in connection with No. 944BRA. However, this adapter may also be used in tube checkers if a proper current-limiting resistor is used, or if the plate voltage is low enough to prevent a high plate current.

No. 944BHR, Fig. 32, is used to test the Raytheon BA and BH tubes in tube checkers. The adapter is placed in sockets which test the '80-type tube. May be used with Jewell models 209, 210, 214, 533, 534, 535, 536, 538, 540, 597, and 675. If desired, these adapters may be used in pairs in connection with set analyzers to give the regular plate-current reading as obtained from the eliminator circuit. Place one adapter on the test plug and

the other in the analyzer socket. May be used with Jewell models 198, 199, 408, 409, 444, 531, 566, 577, 578, 579, and 581 set analyzers and test panels.

No. 955KPT, Fig. 33, is used for connecting an output meter across the plate and screen-grid of pentode tubes. May be used in connection with the Jewell 559 output meter or the Jewell 444 and 660 set analyzers.

No. 955SPT, Fig. 34, is for connecting an output meter across the two plates of a triple-twin tube. May be used in connection with the Jewell models 444, 559, and 660.

No. 965KS, Fig. 16, is also used to test the 89 tube in tube checkers. It is to be placed in the regular '37 socket of tube checkers. May be used with Jewell models 210, 214, 533, 534, 535, 536, 538, 540, and 597.

No. 975KP, Fig. 35, is used to test seven-prong tubes. May be used in any tube checker having a five-hole socket. Used with Jewell models 209, 210, 215, 533, 534, 535, 536, 538, 540, 597 and 675.

No. 950HS, Fig. 36, is a combination adapter employing four different sockets fitted to a basic five-prong base. With this adapter, the 29, 69, 41, 42, PA, PZH, 57, 58 and 82 tubes may be tested from screen-grid sockets of the five-prong type if wired for 2.5 and 6.3 volts. This adapter will also be available with a seven-prong socket so that the new seven-prong tube may be tested. May be used with all Jewell tube checkers and any other type having a 2.5 volt and 6.3 volt, five-hole socket.

No. 421X, Fig. 37, is used on the plug (or its UX adapter) of any Jewell analyzer for plugging into WD-11 sockets. This adapter is used with No. 968.

No. 968, Fig. 38, is used on the UX

* Service Consultant, National Radio Institute, Washington, D. C.

In this second part of a series of articles, details of an additional thirty-three adapters are included.

TEST EQUIPMENT

socket of any Jewell analyzer to hold the WD-11 tube.

No. 999, Fig. 39, is used on the UX analyzer plug or its UX adapter to permit its insertion into UV 199 sockets. This adapter is used with the No. 429 plug.

No. 429, Fig. 40, is used in the UX socket of any Jewell analyzer for receiving the UV199 tube.

No. 954DD, Fig. 41, is a twin adapter for use with Jewell model 137 so that analysis of '24, '35, '36, '38, '39, '44 and '51 tube circuits can be made.

No. 419X, Fig. 42, is used with any Jewell UX plug or its UX adapter for insertion into UV-type sockets. This adapter is used with No. 967.

No. 967, Fig. 43, is placed in the UX socket of any Jewell analyzer to take the UV type tubes.

No. 949K, Fig. 4, is used with the UX plug or its UX adapter to analyze the circuits of overhead heater type tubes. This adapter is used with the No. 944LS.

No. 944LS, Fig. 44, is used with any Jewell analyzer to take the overhead heater type of tubes when analyzing their circuits.

No. 955DGLC, Fig. 45, is used with the Jewell models 198 and 199, old series, to analyze the circuits of the first section of the Triple Twin tubes. This adapter enables all readings to be made by reading the analyzer directly.

No. 955DPP, Fig. 46, is used with the Jewell 198 and 199, new series, 408, 409, 444, 531, 566, 577, 578 and 579 to analyze the circuits of the first section of Triple Twin tubes. This adapter makes possible the direct reading of the analyzer.

No. 954DP, Fig. 45A, is used with the Jewell 198 and 199, old and new series, 408, 409, 444, 531, 566, 577, 578, and 579 to analyze the second section of the Triple-Twin tubes, making all readings direct as

noted on the analyzer.

No. 955GGKC, Fig. 47, is attached to the five-prong analyzer plug or its UY adapter on models 137, 198 and 199 old and new series, 408, 409, 444, 531, 566, 577, 578, and 579 to analyze the circuits of the five-prong Wunderlich tube.

No. 955GGKL, Fig. 48, is placed in the UY analyzer socket and the five-prong Wunderlich tube is inserted in the adapter. It is to be used with the No. 955GGKC above for set analysis of the five-prong Wunderlich tube.

No. 975DD, Fig. 49, is used with the Jewell models 198 and 199, old series, for socket analysis of the new seven-prong power amplifier tube.

No. 975DW, Fig. 50, is used with the 198 and 199 new series, 408, 409, 577, 578 and 579 analyzers for analysis of the seven-prong tube circuits.

No. 975DSW, Fig. 51, is used with the 444, 531 and 566 analyzers for analyzing the circuits of the new seven-prong tube. This adapter is similar to the No. 975DW but has a locking stud to engage the latch in the analyzer plug.

No. 945GL, Fig. 52, is used with the model 566 analyzer being attached to the four-prong adapter of the analyzing plug for analysis of the 33, 46, 47, GA, LA and PZ tube circuits.

No. 954GL, Fig. 53, is used with model 566 analyzer, being inserted in the UX socket of the analyzer to receive the pentode tubes in above analysis test.

No. 968R, Fig. 54, is used with Jewell models 209, 214, 533, 534, 535, 536, 538, 540 and 675 for checking the WD-11 tube in the '26 socket. This adapter has a resistor to drop the filament voltage from 1.5 to 1.1 volts.

No. 944R1, Fig. 55, is used with above Jewell models for checking the 864 tube

(Continued on page 309)

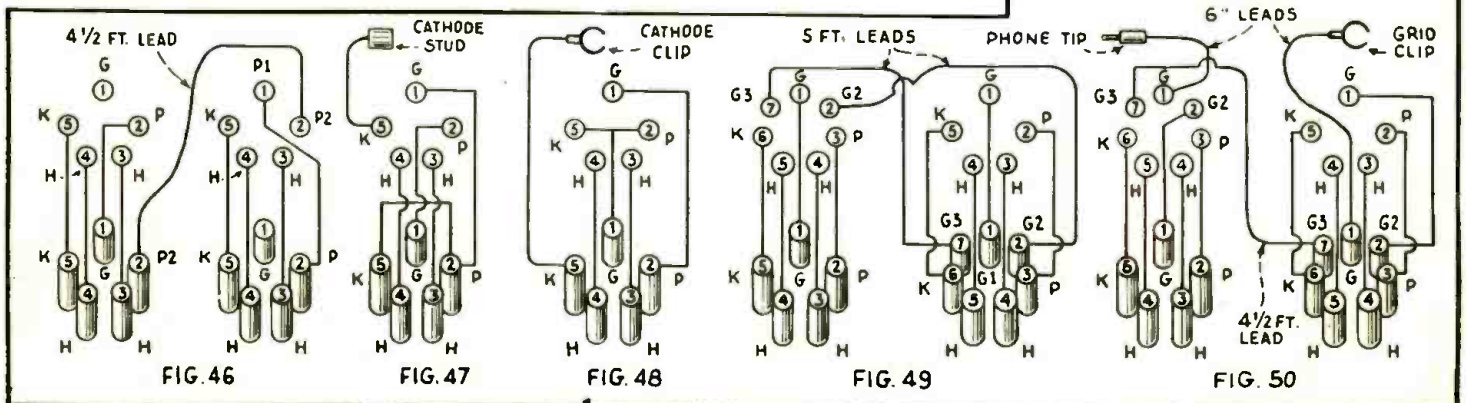
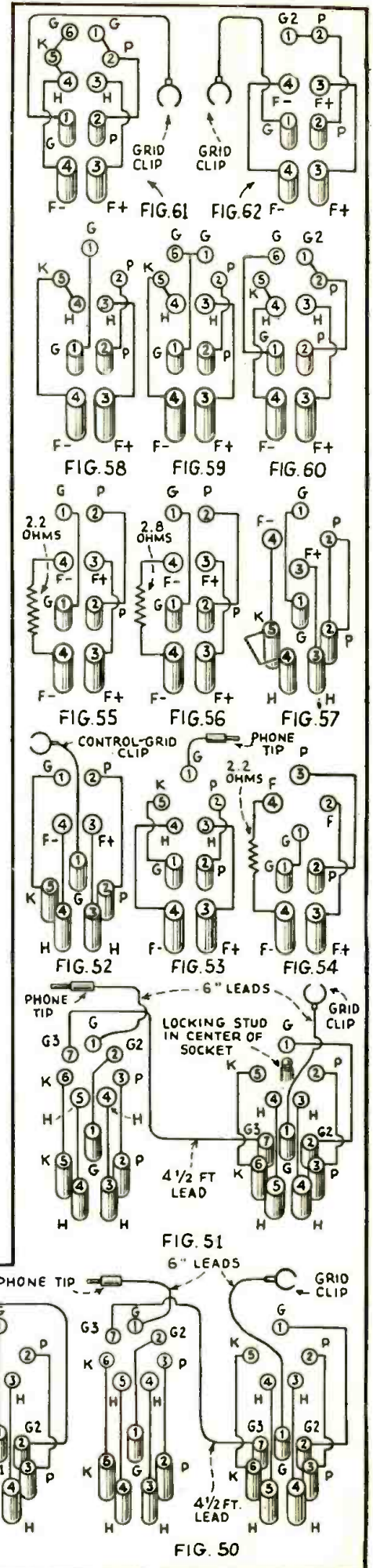

SHORT CUTS IN RADIO SERVICE

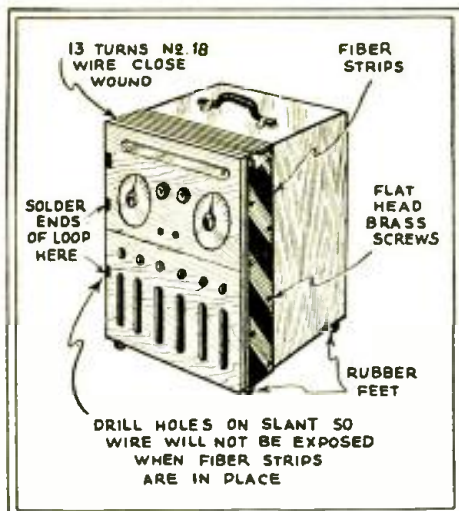

Fig. 1
Illustrating the improved Radiola 26.

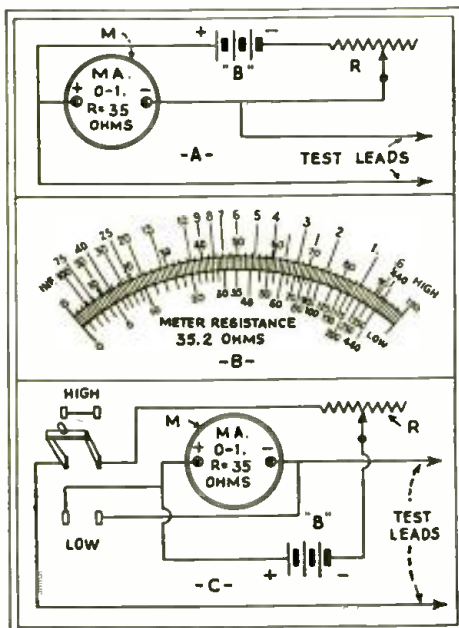

Fig. 2
Schematic of the low-range ohmmeter.

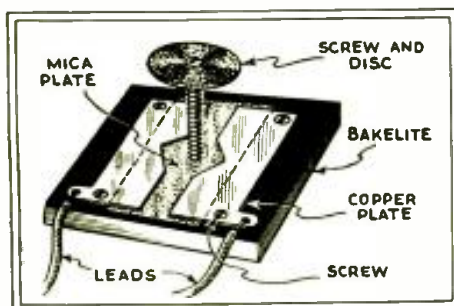

Fig. 3
Drawing of a home-made neutralizing unit.

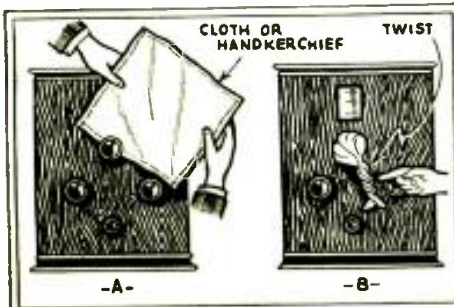

Fig. 4
Just wrap, and pull the knob.

\$10 for Prize Service Wrinkles

Previous experience has indicated that many Service Men, during their daily work, have run across some very excellent Wrinkles, which would be of great interest to their fellow Service Men.

As an incentive toward obtaining information of this type, RADIO-CRAFT will pay \$10.00 to the Service Man submitting the best all-around Radio Service Wrinkle each month. All checks are mailed upon publication.

The judges are the editors of RADIO-CRAFT, and their decisions are final. No unused manuscripts can be returned.

Follow these simple rules: Write, or preferably type, on one side of the sheet, giving a clear description of the best Radio Service Wrinkle you know of. Simple sketches in free-hand are satisfactory, as long as they explain the idea. You may send in as many Wrinkles as you please. Everyone is eligible for the prize except employees of RADIO-CRAFT and their families.

The contest closes the 15th of every month, by which time all the Wrinkles must be received for the next month.

Send all contributions to the Editor, Service Wrinkles, c/o RADIO-CRAFT, 98 Park Place, New York City.

Prize Award

IMPROVING THE RADIOLA 26

By J. E. Deines

A GREAT number of men use the Radiola 26 for locating sources of man-made interference. This receiver is used because it is about the best and most economical set that may be secured for the purpose. Many men who use this receiver experience difficulty with loose connections in the loop circuit; it seems that no matter how much work is done on this loop connection, it just "won't stay put" due to poor construction. In the arrangements shown in Fig. 1, all the difficulties in the loop circuit have been overcome.

The idea consists, briefly, in moving the loop connections to the receiver proper and connecting them to another loop wound over the cabinet as shown in the illustration.

First, remove the loop frame and hinges, being careful not to break the connecting wires as they are unsoldered from the hinges which form the terminals of the loop. Then drill two small holes, as shown in the illustration, so as to meet the old screw holes left by the hinges. Now, remove the small metal discs that are used for feet on the bottom.

Start winding from one of the small drilled holes, 13 turns of No. 18 bell wire; the last turn will be short about four inches, that is, just about equal to the distance between the hinges. Solder the ends of this new loop to the old loop wires. Be certain that the turns of the loop are wound very closely. If not, the tuning dials will not tune alike.

To protect the windings of the loop, cut two strips of 1/16 in. hard fibre, 2 1/2 ins. wide by 13 ins. long and two others, 2 1/2 ins. wide by 14 ins. long. Drill and countersink this fibre strip to take small flat-head screws which should be just long enough to hold the strips. All that remains to be done is to get some of those small rubber feet that were used on old radio cabinets and to replace the ones removed before.

This loop will be found to be highly directional and where the set must be taken out of the car, it will be found far more convenient than the older method of construction. The total expenditure, incidentally, is about 30 cents, plus one-half hour of labor.

A LOW RESISTANCE OHMMETER

By Geo. H. Gabus

AS everyone knows, the conventional continuity tester fails to clearly differentiate between circuits containing a hundred or more ohms resistance and circuits having a resistance of ten ohms or less.

In searching for a continuity meter which would quickly locate shorted condensers (either fixed or variable) in any portion of a receiver without having to unsolder umpteen different wires, your writer developed the circuit shown in Fig. 2A.

The heavy test leads, be it observed, are connected directly in parallel with the meter, and this parallel combination is, in turn, placed in series with a "B" battery of 4.5 or 6 volts and a variable resistance of 7,000 or 10,000 ohms.

The theory of operation is as follows: The series resistor R, because it is at least a thousand times larger than the resistance of the meter, determines to within 1/10 of 1 percent, the total current flowing in the circuit and should be adjusted to the point where the meter M reads full-scale. Now short the test prods and the meter will read "zero" because the meter is shorted. If the test leads are connected across a variable resistance, the meter will read higher and higher as the resistance is increased.

This is in marked contrast to the conventional continuity tester where high readings indicate low resistance and vice versa. If the meter reads half-scale, this indicates that the current is evenly divided, half of it flowing through the meter and half flowing by way of the test leads through the resistance under test. Since the currents are equal it follows that the resistances are also equal and that when the meter reads half-scale the resistance under test is equal to the meter resistance.

It may be shown that the relations between the known and unknown factors may be simply expressed by the formula, $a/b = X/r$ in which a is the current through meter, b is the current through resistance under test, X is the resistance in ohms of the resistor under test, and r is the meter resistance. It appears, further, that a is directly proportional to the meter-reading expressed as a percent of full-scale and that b likewise is directly proportional to $100 - a$. Therefore, X equals $ra/100 - a$. This formula may be used for the calibration of the meter so that its readings may be directly converted into ohms. A further convenience is to make a new scale for the meter reading directly in ohms. Such a meter scale is shown in Fig. 2B and was calculated for a Jewell 0 to 1 ma. meter as used by the writer. Notice that the scale is open and uncrowded.

Figure 2C shows the complete circuit as finally adopted. A D.P.D.T. switch was added to enable the Service Man to change to the conventional continuity tester circuit if it becomes desirable in checking higher resistance values than are included in the low resistance range.

It seems almost superfluous to mention the many uses to which such a tester is specifically adapted. R.F. coils may be directly compared and any difference in resistance indicating a defect.

A HOME-MADE NEUTRALIZING CONDENSER

By Frances C. Wolven

WHILE servicing a receiver some time ago, I was called upon to replace a neutralizing condenser of a rather obsolete type. I did not have one on hand and consequently constructed the one illustrated in Fig. 3.

It consists merely of a small bakelite block upon which is placed a strip of mica. Above the mica are fastened two pieces of copper as shown. An 8/32 machine screw with a copper disc at one end is screwed into a tapped hole in the center of the block of bakelite. By varying the pressure on the copper plates, the capacity of the condenser is varied accordingly.

A feature of this device is its remarkable insensitiveness to hand capacity, while providing micrometric adjustment.

REMOVING KNOBS

By Charles W. Hancuff

FIGURE 4 illustrates a very simple method by which the spring-type knobs, which are used on some of the Philco radio receivers, may be removed. It may also be used, of course, to pull the knob

from the shaft of other condensers without scratching the front panel.

Take a piece of cloth, or your handkerchief, and slip one edge between the knob and the front of the panel as illustrated in Fig. 4A. Then twist the cloth or handkerchief as shown in B and pull outward. The knob will come off easily, and there will be no mark on the radio receiver which is usually made when the screw driver or other hard tool is used.

A CHASSIS REPAIR RACK

By J. Margesam

AFTER marring and bending a few radio chassis, I constructed the repair rack illustrated in Fig. 5. The swinging table is so arranged that almost any size chassis may be conveniently bolted down. You may find, however, that four small clamps will come in handy. This rack was constructed because it was found extremely easy to service receivers when their chassis could be turned upside down without hindrance of any sort. When the end clamp is tightened and bottom of the chassis is open, I can work without interference from the rack. A convenient addition is a service lamp, placed as shown, which illuminates the entire chassis very nicely. The swivel and friction clamps were taken from an old car windshield; it may be necessary to weld one of the friction plates on each end of the table. It might also be well to weld the table angle-iron at the corners after cutting and bending.

Detailed drawings of the respective parts are shown on the same figure below the main diagram. The parts required for this interesting device are as follows:

- Two 1/2 in. nipples, 8 ins. long;
- Four 1/2 in. nipples, 5 ins. long;
- One 1/2 in. nipple, 24 ins. long;
- Three 1/2 in. elbows;
- Five 1/2 in. tees;
- One 1/2 in. end-insulator;
- Two 3/4 in. angle irons, 36 ins. long;
- Two 1/4 x 3/4 in. flat iron, 11 3/8 ins. long;
- Two pieces of No. 16 gage sheet iron 6 x 12 ins.;
- One 1/2 to 3/8 in. reducer;
- Thirty feet of 1/8 in. pipe.

Note that the reducer is drilled to house the 1/8 in. pipe.

REMODELING SPARTONS

By Walter McMillen

HAVE a little kink regarding Sparton models 69 and 79 which use 6 type 484 special tubes. I installed all UY '27's in place of the 484 tubes with only one necessary change.

The power transformer has three different taps as illustrated in Fig. 6, and to make sure that you are getting the right filament voltage, it is best to plug your analyzer in one of the '27 sockets and then turn the switch on the power transformer until a reading of 2 1/2 volts is shown.

The set I changed over this way works just as well with the '27 as with the 484 tube, and of course the '27's are much easier to secure.

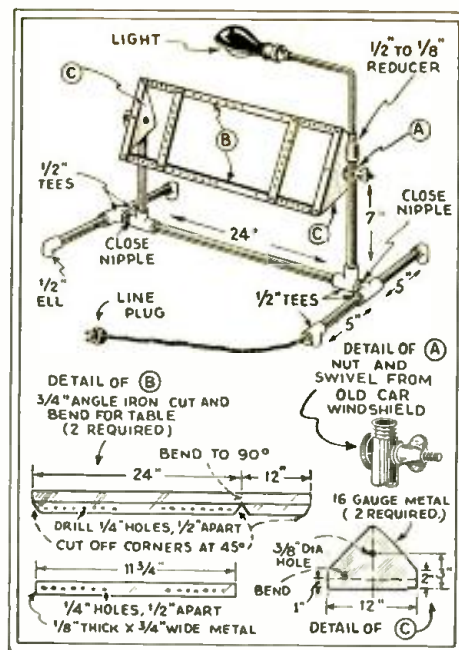

Fig. 5

Here's a real asset to any service shop.

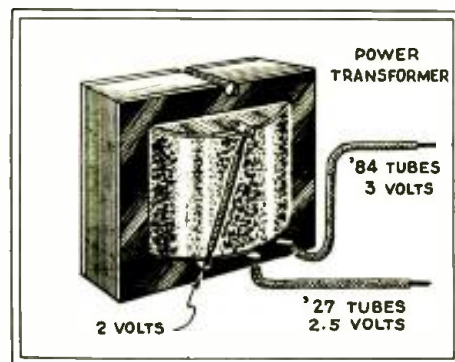

Fig. 6

Changing over the Sparton 69 and 79 sets.

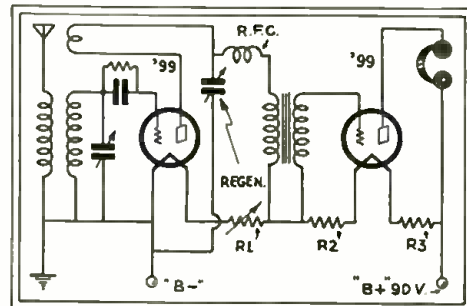

Fig. 7

No "A" battery required for this receiver.

TAKING "A" FROM "B"

By Robert C. Reinhart

THE writer employs the system of connections shown in Fig. 7 for eliminating the usual "A" battery in a portable short-wave receiver which uses type '99 tubes. Of course, the same method could be used in conjunction with tubes of the 2-volt type.

Naturally this circuit imposes a heavy drain on the "B" battery, but when lightness and compactness are of prime importance, this method would be found to give fine results. In Fig. 7, resistor R1 is a 500-ohm variable unit; for type '99 tubes operating on the "B" voltage indicated, the value will be 367 ohms. Resistor R2 is 50 ohms; and R3, 1,000 ohms. The balance of the circuit is standard.

THE ANALYSIS OF RADIO RECEIVER SYMPTOMS OPERATING NOTES

By CHARLES WACKID

THE following is an account of some of the peculiar problems encountered in servicing well-known types of receiving sets:

Atwater Kent Models 80, 82, 85 and 89

Several of these models were brought in for repairs recently, the complaint being "volume control not functioning." We went over the sets completely, checking the voltages, volume control, etc., but found everything O.K. We then checked the circuit and found that the volume control varied the cathode potential of the A.V.C. tube, as illustrated in Fig. 1. On inspection we found a high resistance connection between the oscillator tube cathode-prong and the socket. The defect was remedied by cleaning and tightening the socket prongs.

Another complaint in the models 82, 85 and 89 was poor sensitivity, which was traced to the A.V.C. tube, a type '24. To test this, remove the type '24 A.V.C. tube from its socket, with the set tuned to a station and with the volume control set at maximum; if the volume increases when this tube is removed, then the tube needs replacing.

The next "pain in the neck" was an Atwater Kent "89." The complaint was noise. An inspection of the set proved that the noise was developed in the set itself. It took us three hours to find this trouble which was a noisy type 35 variable-mu tube.

Marconi Models 1930 Standard, Junior and Senior

The Canadian Service Man will come

across these sets quite frequently and unless pointers are shown to him, he will probably be baffled for a while. In all of these models the complaint of "no reception," when everything apparently checks O.K. is most likely due to compensators going out of adjustment. The remedy, of course, is to realign the circuits. This defect in the Junior models may also be due to a dirty variable resistor which tracks with the tuning gang. Cleaning the resistor with graphite will at once restore the volume.

Pierce-Airo Model 524

The next "sticker" was a 524 Pierce-Airo Mantel model. The "complaint" was motorboating. After being on for about five minutes the set would break into a loud motorboating that would almost drive you out of the house. The trouble was found to be in the bypass condenser-block. There was a high resistance connection between the condenser-block ground and the chassis ground. The location of this condenser is shown in Fig. 2.

Philco Models 96 and 296

No screen-grid voltage on the second and third R.F. tubes is due to an open 200-ohm resistor feeding these tubes. As this resistor is molded into one unit with a bypass condenser it makes it very hard to locate unless one has worked on these sets before. The position of the unit is illustrated in Fig. 3.

Philco Models 70 and 90

Complaints of cutting off after being on for about five minutes in these models

was found due to defective pentode tubes. Frequent complaints of weak reception also were reported; the trouble was cleared up by replacing the A.F. coupling capacitors which were open.

Brunswick Model 15-S

In this model weak reception was caused by a high resistance connection to the control-grid of the second R.F. tube.

Sparton 931 Series

No plate voltage on these models is usually due to a shorted plate bypass condenser. In replacing this condenser always replace with a 400 volt working condenser, as the ordinary ones frequently break down after being installed a few days.

Victor 1928 Model (Chassis by Bosch)

These models may be greatly improved by simply replacing the grid leak with a 1 meg. unit. The volume in some cases has been increased 100 percent.

Stewart-Warner 950 and R-100

In replacing the '24's in these models with the new quick-heater tubes (type 24A) the circuits will oscillate at the higher frequencies. This condition may be remedied by adding more capacity across the source of screen-grid voltage, as shown in Fig. 4. Such trouble as this involves is well repaid by the increase in volume.

Improving the King 6J

As there are a great number of these sets still in use the Service Man can net (Continued on page 311)

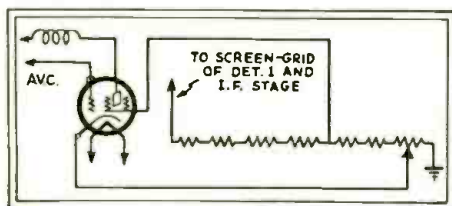

Fig. 1
Cathode circuit of the A. V. C. tube.

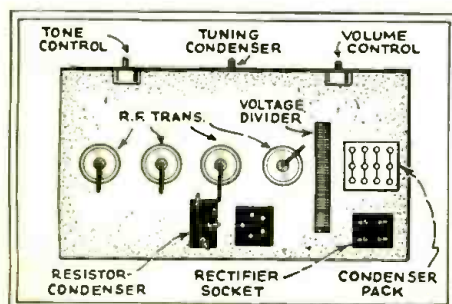

Fig. 2
Location of the condenser in the Pierce-Airo.

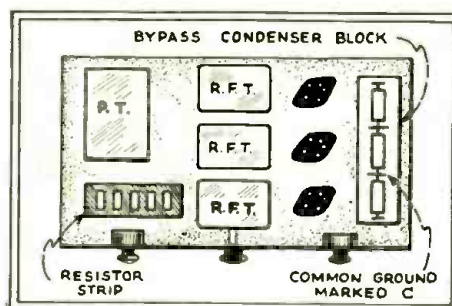

Fig. 3
Position of the resistor in the Philco 96, 296.

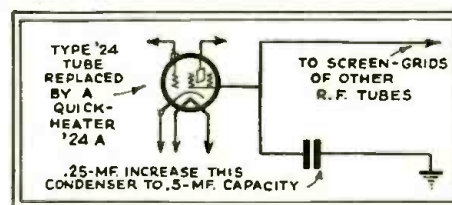

Fig. 4
Additional capacity is essential here.

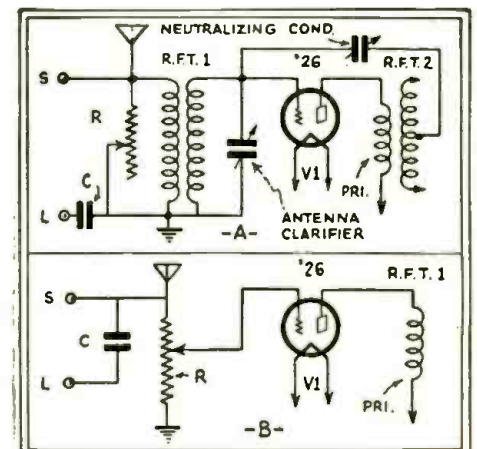

Fig. 5

The King model 6J may easily be improved upon by removing the antenna "clarifier" and substituting a tone control in its stead; and the volume control shunted across the antenna and ground posts as stated by the author.

THE SERVICE MAN'S FORUM

Where His Findings May Benefit Other Radio Technicians

CASTE LASSEOS VISITORS

Editor, RADIO-CRAFT:

You will probably be interested to know that since the publication of our shop photo in the August, 1932 issue of RADIO-CRAFT, page 97, we have been visited by no less than nineteen out-of-town Service Men! All were loud in their praise of radio and RADIO-CRAFT—Their Magazine—and we can only say, "we thank you."

We would not do without your magazine; and the Official Manual is the most used book in our library.

Oh, yes, the people we buy from—nine out of ten by actual count (September issue)—are RADIO-CRAFT advertisers.

R. M. CASTE,
Dunbar Radio Co.,
Dunbar, W. Va.

(Mr. Caste, it will be recalled, is the gentleman who deplored his ability as a mill-pusher. However, if he can pull in customers with the same efficiency he exhibits in playing the part of host to the service fraternity, he must have a very good radio service clientele by this time.—Editor.)

NOW THE TAXI-STAND SERVICE SHOP

Editor, RADIO-CRAFT:

The readers of RADIO-CRAFT may be interested in the illustration of my taxi-stand radio service shop, Fig. A. Although the building makes a unique appearance, due to its seemingly diminutive size, it nevertheless is plenty large enough for use as a radio service shop.

The "edifice" was built to be used as a taxi stand, but it was never opened as such. Located on a busy side-street, it yet is so situated that there is plenty of parking space around the building—and adequate room inside to take care of the automotive radio service work which is our specialty.

At present, I am working on an adapter for the Bell & Howell 16 mm. film projector, to get the sound off the film; we have succeeded in getting the sound onto the film. My associate is making a Travelogue of Kentucky. Watch for it.

I am a booster for RADIO-CRAFT, as I get so many helpful hints and short-cuts for my work.

F. B. LATHAM,
The Radio Laboratory,
Richmond, Ky.

(Well! Well! Have any Service Men discovered similar possibilities in a filling station?—Editor.)

AN "OPERATING NOTES" BOOSTER

Editor, RADIO-CRAFT:

Just a few comments regarding RADIO-CRAFT.

Personally, I feel that the most commendable feature is its publication of reports of difficult service problems solved by good practical radiomen. Almost every radio manufacturer's products develop some service peculiarities not anticipated by the manufacturer's service literature, and the published discoveries and solutions of such peculiarities make excellent reading and reference material for the radio servicing profession.

For instance, the 1929-'30 Edison (green chassis) radio sets frequently develop a trouble which, when first diagnosed, indicates a shorted filter condenser, but is generally found to be a grounded speaker field circuit, the ground resulting from a leakage through the speaker terminal strip to the chassis.

I searched about an hour for this leakage when it was first encountered on this model, and probably other radio men have done likewise.

Now, if the first man who discovered this weakness of this model had reported the peculiarity to you, knowing that it would be gladly published, many radio men would probably have been saved much time when first encountering this particular deficiency.

I would like to see more encouragement offered for such data from the field, to be classified and properly headed by manufacturer's names, and by models, as a sort of national service data exchange.

Your magazine has made a remarkable beginning in this direction and I hope you will carry on with more of such practical facts. What do you think of the suggestion?

FLOYD FAUSETT, Chief Engineer,
Supreme Instruments Corp.
Greenwood, Miss.

THE Official Radio Service Men's Association, sponsored by RADIO-CRAFT, invites all Service Men who are not members of the Organization to write for an application blank. It is the official service organization of this maga-



Official label button of the O. R. S. M. A.

zine and is maintained solely for the interests of Service Men. Membership cards are issued upon passing a written examination which is forwarded by mail. Write for yours today. The O. R. S. M. A., 98 Park Place, N. Y.

(Judging by the pile of letters we have accumulated, the Operating Notes and Data Sheets departments of RADIO-CRAFT are running a fast and furious race for the position of "first place" in the interest of radio Service Men. Most of these technicians have found it extremely profitable to make an index, in

accordance with their personal ideas, of these bits.

(However, all the readers of RADIO-CRAFT will be interested to know that in a short time there will be available a complete index to all the articles which have appeared in the past issues.—Technical Editor.)

"A DYNATRON V.T.-VOLTMETER"

Editor, RADIO-CRAFT:

Several experimenters have written to the writer, reporting that the needle of their meter tends to go off-scale when connected into the dynatron circuit described in my article, "A Dynatron Vacuum-Tube Voltmeter," in the April, 1932 issue of RADIO-CRAFT, page 614. If you would draw attention to the facts below, builders of this meter would no doubt find that these comments clear up their troubles.

They are evidently trying to get the meter to "stay on scale" with the input terminals open. Under this condition the needle will go off-scale, as the grid circuit is open. However, the meter will indicate within its scale range with the voltages

(Continued on page 309)



Fig. A
Believe it or not—this is a radio service shop.

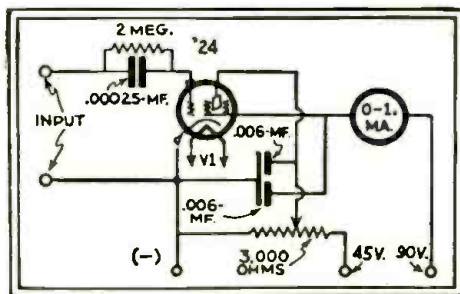

Fig. 1 A "dynatron" V.T. voltmeter circuit.

KOLSTER MODELS K-140 AND K-142 10-TUBE SUPERHETERODYNE

(Dual reproducers, dual band-selectors, antenna transmission line, phono-radio operation; A.V.C.; provisions for connecting remote control and an S.W. converter; neon-tube visual tuning.)

A radio receiver that excellently represents the advances which have been made in radio receiver design is the Kolster model K-140 (50- to 60-cycle) and the model K-142 (25- to 60-cycle) 10-tube superheterodyne.

Following are the condenser values employed in these classes: C1, C2, C3, C4, 4-gang tuning condenser unit; C1A, C2A, C3A, C4A, R.F. trimmer condensers; C5, padding condenser, 600 mmf.; C5A, pad R.F. trimmer condenser; C6 to C11, I.F. trimmers; C12, tone control, 50 mmf. to .0045-mf.; C13, 0.5-mf.; C14, C31, 100 mmf.; C15, C16, C23, C24, C29, 0.1-mf.; C17, 1. mf.; C18, C25, 500 mmf.; C19, C20, C21, dry electrolytic, 8 mf.; C22, dry electrolytic, (25 cycles, only), 4 mf.; C26, C28, C30, 0.25-mf.; C27, .01-mf.; C32, .025-mf.; C33, electrolytic, 4 mf.

Resistor R1, manual volume control, 0.5-meg.; R2, 500 ohms; R3, R4, R5, R6, R9, R14, R23, 0.25-meg.; R7, 750 ohms; R8, 0.5-meg.; R10, R16, R19, R20, 25,000 ohms; R11, R15, 5,000 ohms; R12, 75,000 ohms; R13, 50,000 ohms; R17, 3,000 ohms; R18, 0.1-meg.; R21, 10,000 ohms (60 cycles), or 8,000 ohms (25 cycles); R22, 10,000 ohms.

Tube operating characteristics at a line potential of 115 V. are as follows: Filament potential, V1 to V9, 2.3 V.; V10, 4.7 V. (The following potentials are measured to the cathode of the respective tube indicated.) Heater potential, V1, V4, V5, 2.5 V.; V2, 6 V.; V3, V6, zero; V7, 10 V. Control-grid potential, V1, 0.2-V.; V2, V6, 1. V., and V7, 1. V. (with vol. control at maximum) to 10 V. (with vol. control at minimum); V3, 2V.; V4, 6 V.; V5, 3.6 V.; V8, V9, 4 V. Screen-grid potential, V1, 85 V.; V2, 80 V.; V4, V5, 110 V.; V8, V9, 245 V. Plate potential, V1, 130 V.; V2, 120 V.; V3, 90 V.; V4, V7, 175 V.; V5, 180 V.; V6, zero; V8, V9, 225 V.; V10, plate-to-plate potential, 725 V. A.C. Plate current, V1, 1. ma.; V2, 0.4-ma.; V4, 1.1 ma.; V5, 1.2 ma.; V8, V9, 5 ma.

Any attempts to align the I.F. circuits of the K-140 chassis in the usual manner

will result in instability and poor over-all fidelity, if adjustments are made in the conventional manner and with a modulated oscillator, tuning for maximum output. In fact, no attempt should be made to vary these settings, which are determined by special test equipment at the factory for obtaining 10 kc. selectivity throughout the entire broadcast band, unless it is absolutely necessary. The procedure is as follows:

Remove the voice-coil shunt connection and connect the output meter to the secondary of transformer T2. Next, remove the oscillator tube and the cap lead of V5, and connect the output of a 175 kc. service oscillator to the cap of the tube. Then, adjust C10 and C11 for maximum output. Replace the cap lead, couple the service oscillator to V4, and adjust C8 and C9 for maximum output at 175 kc. Next, couple the service oscillator to V2 and adjust C6 and C7 for maximum at 175 kc. The oscillator output should be coupled directly to the grids, without a dummy antenna. If the oscillator is capacitively coupled the open grid circuit may result in circuit oscillation; in this case the grid circuit may be completed to ground through 1,000 ohms.

Now, to obtain the full tone quality for which the reproducers and the balance of the set are designed, it will be necessary to flatten out the I.F. channel so that it presents uniform gain for frequencies of 170 and 180 kc. (The gain with the flat-topped adjustment is less than when the circuits are adjusted for peak resonance.)

Set the service oscillator at 180 kc. and adjust the I.F. trimmers to obtain a preliminary output reading; repeat this performance, at 170 kc., to obtain the same output reading. (It will be necessary to go over the six trimmers several times.) When thus aligned the I.F. amplifier portion of the receiver should indicate the same gain at 170 and 180 kc., and less at 175 kc.

In aligning the R.F. circuits, it is necessary that the R.F. selectivity be superimposed on the middle of the I.F. selectivity

graph in order that the overall selectivity figure will be symmetrical. Replace the oscillator tube and shield, couple the service oscillator to the antenna and ground terminals of the chassis (not the antenna terminal and the chassis), and operate the service oscillator at 600 kc. Adjust C4A for maximum output, while rocking the tuning dial across the 600 kc. setting, until the output remains fairly constant with a shift of several kc. either side of 600 kc.; then, finish by adjusting C1A, C2A and C3A. Reset the service oscillator to 1,400 kc. and align the oscillator circuit first. By adjusting the oscillator trimmer it is easy to locate the two peaks and the dip in the middle; the oscillator should be aligned for this dip. Finally, align the remaining R.F. circuits by adjusting C1A, C2A and C3A for maximum output. Alignment at 1,400 kc. should not affect alignment at 600 kc.

The insert indicates the circuit arrangement at the rear of the chassis for phono-radio operation; also, remote control (terminals 1 and 2). Transformer T3 and resistor R1 must be matched to the pickup, if it is of low-impedance type; T3 may be omitted if the pickup is of high-impedance type.

If the neon beacon tuning beam does not extend sufficiently high during the reception of distant stations, it may be necessary to reduce the value of resistor R2 to perhaps 7,000 ohms. If the value is made too low, the beam length will extend too far during the reception of local station programs.

A complete Kolster installation includes an antenna "rejectostat" (coupler), an R.F. transmission line (as contrasted with the relatively inefficient "shielded lead-in" ordinarily used) up to 1,000 ft. long, and a receiver rejectostat" (coupler); this greatly reduces the proportion of noise pickup. The R.F. transmission line is No. 18 rubber-covered twisted pair, shielded with copper-braided sleeving, and protected with a 1/16-in. rubber covering; (or Bellini Transmission Line Shielded Cable may be used).

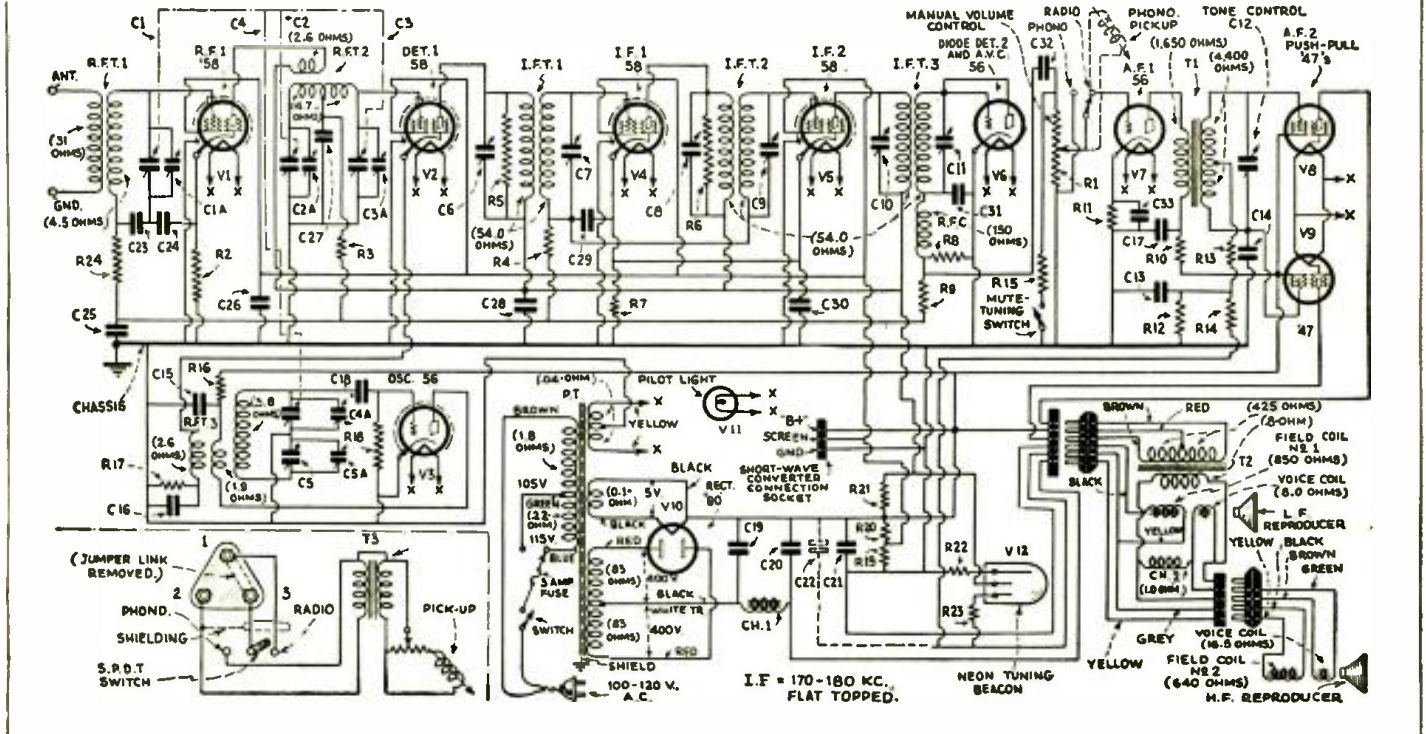

COLUMBIA MODELS C-90A (Single Reproducer) AND C-90B (Dual Reproducer)

11-TUBE SUPERHETERODYNES

(Incorporates A.V.C., phase-reversing tube, reactance resonance indicator, "silent tuning" tube.)

A number of unusual features recommend the Columbia Model C-90A and C-90B receiver chassis to the close attention of Service Men. To maintain these chassis at maximum efficiency it is essential that the technician be thoroughly familiar with their individual features.

Following are the values of the components: Condensers C1, C2, C3, tuning condenser gang, shunted by trimmers C1A, C2A, C3A; C4 to C7, I.F. trimmers; C8, C10, C11, C12, C17, 0.1-mf.; C9, C29, C30, 0.25-mf.; C13, .02-mf.; C14, C15, C16, C19, C20, C21, .01-mf.; C22, C23, 500 mmf.; C24, 32 mf.; C25, 16 mf.; C26, 10 mf.; C27, 7 mf.; C28, 20 mf. Condensers C24 to C28 are dry electrolytic units. Condensers C8 to C12, and C29, C30 are contained in one can; C13, C14, C15, C18, in another.

Resistor R1, hum control, 20 ohms; R2, "silent tuning" control, 20,000 ohms; R3, manual volume control, 0.2-meg.; R4, tone control, 0.25-meg.; R5, 180 ohms; R6, 700 ohms; R7, 400 ohms; R8, 0.5-meg.; R9, 50, 50,000 ohms; R10, R12, R14, R15, R18, R19, 0.3-meg.; R11, R13, R20, 0.1-meg.; R16, 30,000 ohms; R17, 2,000 ohms; R21, 230 ohms; R22, 6,700 ohms; R23, 2,400 ohms; R24, 18,000 ohms. Resistors R5, R6, R7, R21, R22, R23, R24, multiple wire-wound unit.

Following are the tube operating characteristics: at a line potential of 115 V. and the "synchro-silent tuner" all the way counter-clockwise, (all D.C. potentials are to ground): Filament potential, all tubes, 2.5 V. Plate potential, V1, V2, V4, 255 V.; V3, 75 V.; V6, 200 V.; V7, 116 V.; V8, V9, 240 V.; V10, too small to measure practically. Plate current, V1, V3, 4 ma.; V2, 2.6 ma.; V4, 4.4 ma.; V6, V10, too small to measure practically; V7, 1. ma.; V8, V9, 60 ma.; V11, 160 ma., total. Cathode potential, V1, V4, 2 V.; V2, 9 V.; V3, 12 V.; V5, V10, zero; V6, 75 V.; V7, 32 V. Screen-grid potential, V1, V2, V4, 75 V.; V6, 120 V.; V7, 116 V.; V8, V9, 255 V.; V10, 73 V. Screen-grid current, V1, V4, 1. ma.; V2, 0.6-ma.; V6, too small to measure prac-

tically; V7, 0.3-ma.; V8, V9, 6.6 ma.; V10, 3.8 ma.

Because of the elimination of noise between stations, by means of the synchro-silent tuning connection, it has been possible to improve the sensitivity of the C-90 chassis to several times that heretofore used. In cases where low sensitivity is encountered, the adjustment of the synchro-silent tuning control should be carefully checked, as well as all the tubes in the R.F. end of the chassis. This should always be done before attempting to increase sensitivity by re-aligning the condensers.

The function of the "silent tuning" or "synchro-silent tuning control" is as follows: One of the type C-57-S tubes is used as V6 because of its sharp plate current cut-off characteristic. By inserting a high negative bias on the suppressor-grid of this tube, it is "blocked," and no signal will come through.

To obtain this action a type C-57-S tube is used as the "silent-tuning" tube, V10. Its plate current through resistor R8 develops a voltage drop which is applied to the suppressor-grid circuit of V6, to which it is common. Tube V10 obtains its control-grid potential from the A.V.C. circuit. When there is no station tuned in, there is no A.V.C. potential, and hence the control-grid of the silent-tuning tube V10 is approximately at zero bias. The resulting high plate current passes through R8 and develops the high blocking potential which is effective on V6.

Now, when a station is tuned in, the A.V.C. potential develops across resistor R9 and is impressed on V10 in the form of a negative bias. The plate circuit of V10 therefore draws little or no current and hence the voltage drop across R8 disappears, leaving nothing but the normal operating bias on V6. In this condition the entire set is operative just as though there were no silent-tuning tube in the circuit. In fact, it is possible to tune in a station and remove V10 without any noticeable change. On the other hand, if V10 is re-

moved when no station is tuned in, the customary background noises will be heard. Resistor R2 is provided to govern the point at which V10 "takes hold"; it compensates for local noise conditions and variations in individual antenna systems.

To obtain push-pull operation and yet retain resistance-capacity coupling, tube V7 is used to obtain a reverse-phase potential to actuate the control-grid of one power tube, V8. The circuit is carefully balanced to prevent a change in the magnitude of the voltage through V7.

The operation of the "reactance resonance indicator" circuit, which centers around transformer T2 is as follows: When the set is turned on and the tube filaments warm up, but no station is tuned in, a relatively large plate current flows through the center winding. This saturates the iron core, reducing the reactance of the two outer windings to a very low figure, which causes considerable current to flow through the pilot light, V12. When a station is tuned in, it operates the diode, V5, so that an A.V.C. potential is built up across resistor R9. This bias voltage is, in turn, impressed upon the control-grids of V1, V2 and V4. The result is normal A.V.C. operation—amplification is decreased. However, their plate current is decreased, due to the higher negative bias on their control-grids. This reduced plate current flowing through the center winding of the reactor relieves the saturated condition in the iron core so that the reactance of the outer windings increases and the current flowing through the pilot light current supply is therefore reduced, causing the pilot light to dim when a station is tuned in.

The two outer windings are connected so that they buck each other, insofar as the center leg of the core is concerned; hence, current is not induced into this center winding (which is in the plate circuit). Electrolytic condenser C28 compensates for slight imbalances.

Field coil resistance, 1,000 ohms (single); or, 520 ohms each (dual).

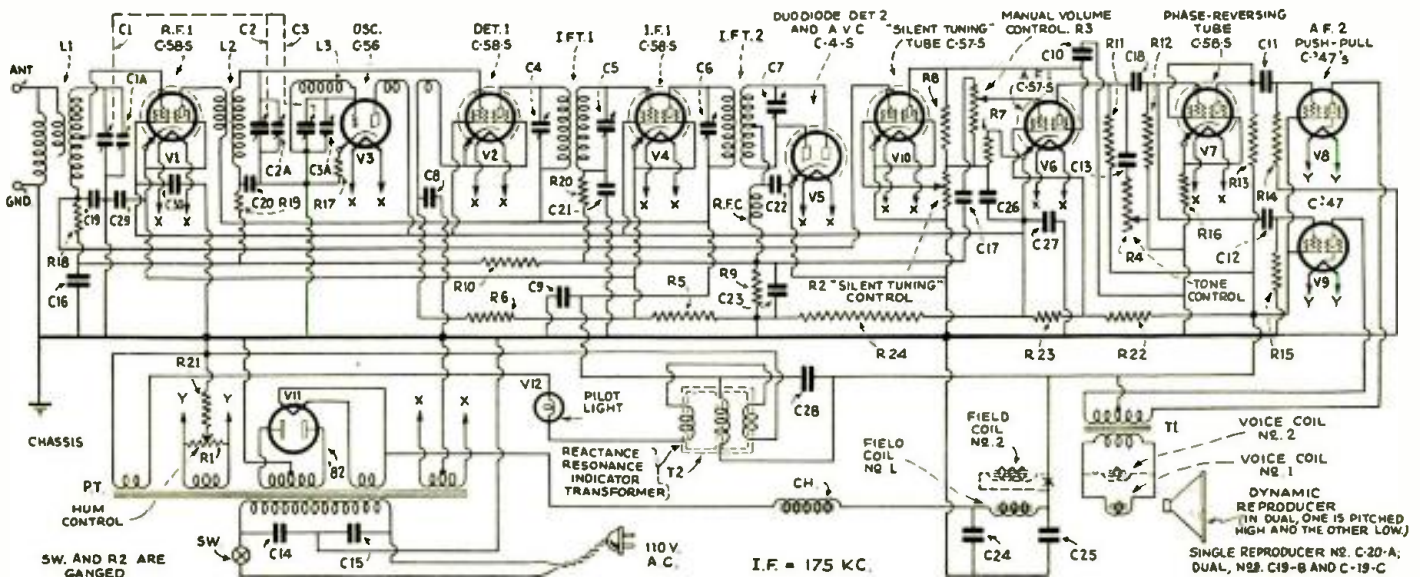

AN ALL-WAVE SUPER-HETERODYNE

By E. H. SCOTT*

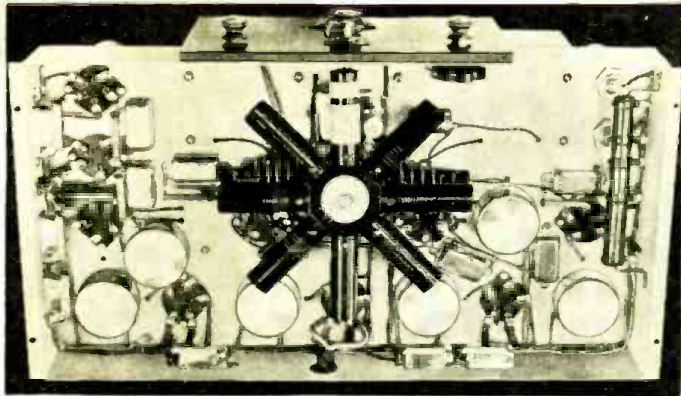

Fig. B

Under-chassis view of the new superheterodyne. Note the arrangement.

JUST as broadcasting swept the country a few years ago, so short-wave radio, combined with a standard broadcast receiver, is being sought by those who desire the acme of radio reception. The advantages to be gained by such a combination have been discussed in these columns before, but a description of a receiver incorporating some of the most modern advances in the field always arouses interest. The receiver to be described is known as the Scott All-wave DeLuxe Superheterodyne which con-

sists of twelve tubes and has the following characteristics:

A pre-selector stage using a '51 variable-mu tube; a first detector using a '24 screen-grid tube; an oscillator using a 56 tube; three stages of I.F. with four tuned circuits and three type '24 tubes. Each of the I.F. stages is completely shielded and isolated from the others, and employs a new system of I.F. amplification giving extremely high gain without loss of stability. Additional features are the use of the 56 as a second detector; three stages of resistance-coupled audio amplification, using two type 56's and two type '45 tubes, the latter being push-pull; and last, but not least—twin, laboratory matched speakers.

selectivity from 15 to 550 meters. The single dial tuning, without external trimmers, is indeed a novel idea.

The gain, or sensitivity of a superheterodyne receiver depends largely on the efficiency of the I.F. amplifier. Reference to the schematic circuit of Fig. 1, indicates that the design of the I.F. coupling used in this model is radically different from that employed in other superheterodynes.

It consists, briefly, of a highly developed tuned impedance circuit in which each unit in each stage is thoroughly shielded from each other, and from other circuits in the receiver.

Laboratory curves of the audio amplifier show that the response is flat within plus or minus 2 db from 30 to 8,000 cycles. Each stage of amplification is of the class A or linear type. This arrangement produces a high degree of quality and is used in preference to the class B system which delivers a much higher output, but at the same time, much greater distortion.

Since most broadcasting stations do not modulate frequencies above 5,000 cycles, and since a large part of the tube hiss and interfering noises such as static,

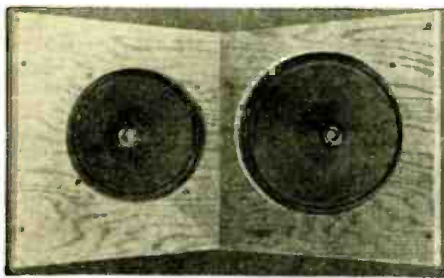

Fig. A

The twin-matched speakers in the Scott super.

Description of the Circuit

The oscillator circuit utilizes one of the new 56 tubes, while the first detector incorporates a type '24 tube with plate rectification, and is coupled to the oscillator in such a way that it not only gives perfect modulation, but at the same time automatically tracks or aligns the tuning of the circuits so they may be operated by a single dial without loss of sensitivity or

*President, E. H. Scott Radio Laboratories, Inc.

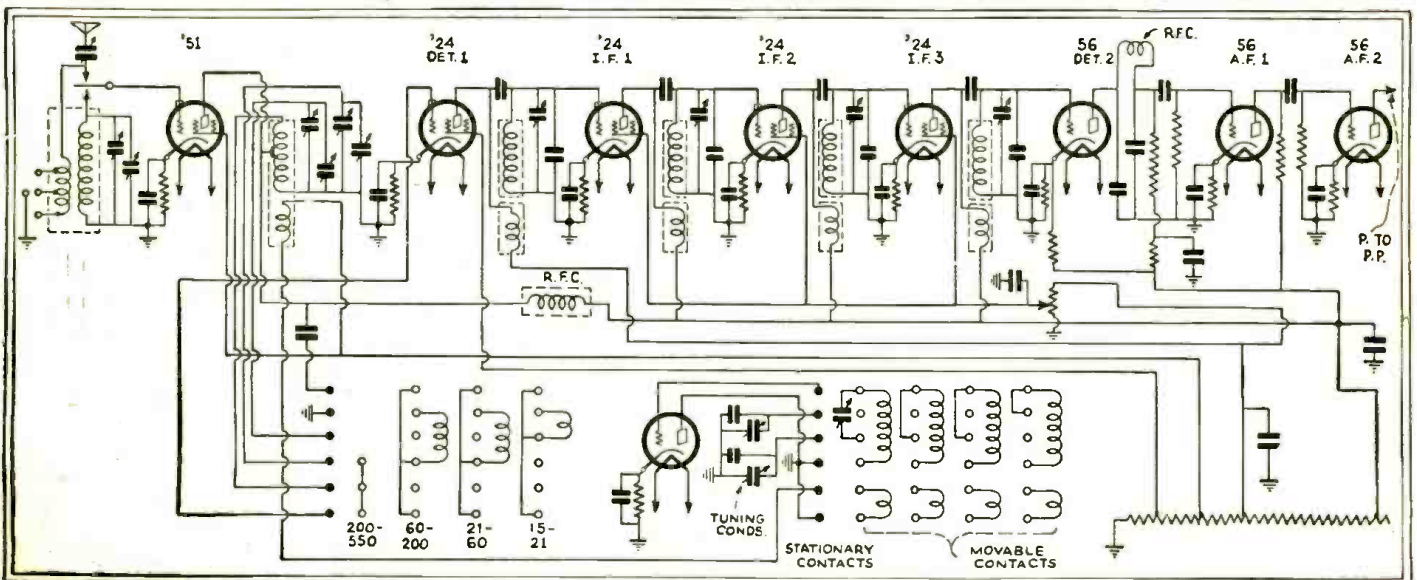

Fig. 1

Complete schematic circuit of the Scott Allwave DeLuxe receiver.

A distinctive superheterodyne is one that rigidly adheres to the rules underlying good radio design. This article illustrates what really can be done with modern apparatus in a commercial laboratory.

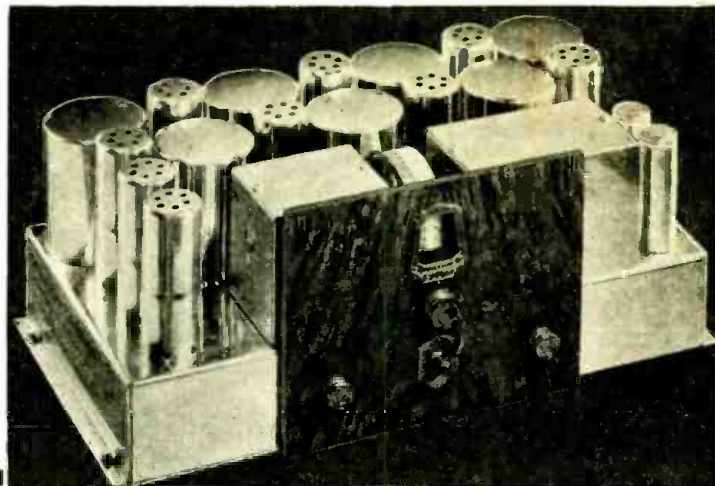

Fig. C
Front view of the receiver illustrating the arrangement of the parts.

etc. occur at frequencies above 5,000 cycles, a low-pass, audio filter designed to cut off frequencies above 5,000 cycles is incorporated in this amplifier to effectively reduce the noise level of the receiver. This results in remarkable clarity of distant stations.

Twin Speakers Used

Recent investigations indicate that it is quite impractical to depend upon a single speaker to deliver full output at all of the audio frequencies used in radio reception. Experiments proved, therefore, that the road to tone perfection lay in the use of two matched speakers. This combination eliminates the peaks or resonant points which sometimes cause "boom" on the bass notes and tinny reproduction on the treble notes. An illustration showing the twin reproducers used is given in Fig. A.

Plug-in coils, while efficient, are inconvenient to use, and it is necessary when changing from one waveband to another to pull out one set of coils and insert another. This receiver employs a separate coil for each waveband in a mechani-

cal change-over device, which has proven highly efficient because of the fact that the design enables even shorter leads to be used between the coils and the tube sockets than with ordinary plug-in arrangements. Fig. B, an under-chassis view of the receiver, shows very well the unique mechanical layout.

The entire switching unit is mounted on a die-cast frame; the coils being placed within the base of the chassis, completely shielded and operated by a small lever on the front panel. The coil contacts may be seen directly between the two coils in the center, and they connect directly to the oscillator and detector tubes. The socket for these tubes will be noticed just at the back of the switch contact.

All tuning is done with one knob, operating single dial, without any other adjustments from 15 meters right up to 550 meters. While single dial receivers are common for the broadcast band, I believe this is the first all-wave receiver that tunes more than one circuit on the short

waves with a single dial, without the use of external trimmers. Usually, short-wave receivers using a stage of R.F. ahead of the first detector have used either two dials or a single dial with auxiliary trimmer condensers. A single dial has been
(Continued on page 298)

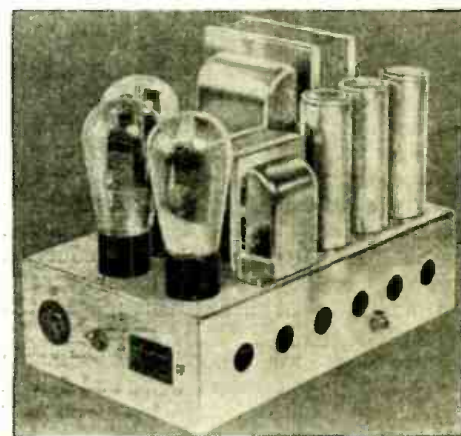

Fig. D
The power amplifier used with the Scott receiver.

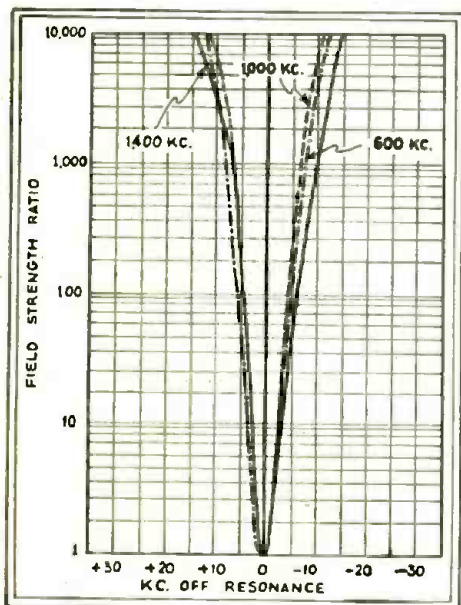

Fig. 2
Selectivity curves of the receiver. Note the sharp resonant curves.

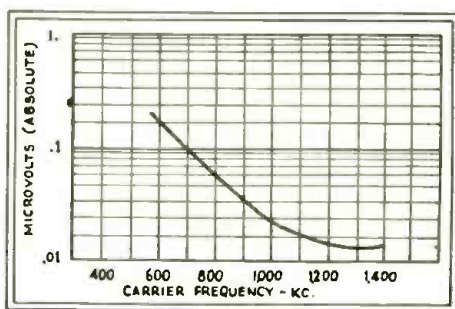

Fig. 3
Sensitivity curve of the set.

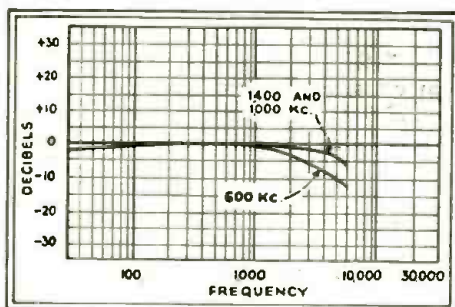

Fig. 4
Here's real fidelity.

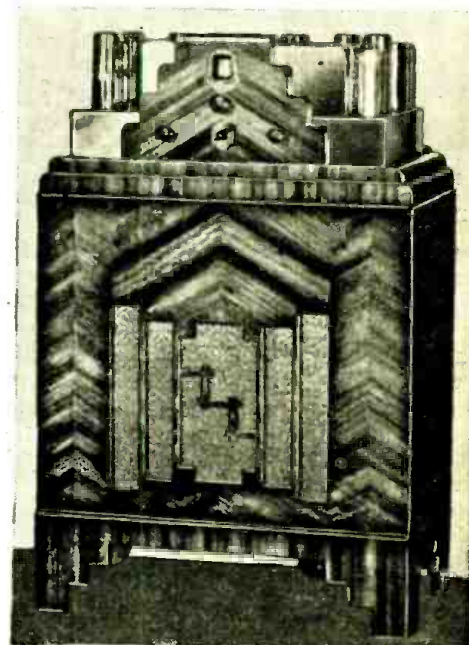

Fig. E
The "Napier," a distinctive Scott model.

THE RADIO CRAFTSMAN'S PAGE

The Bulletin Board for Our Experimental Readers

RE. "NOVEL EXPERIMENTS

Editor, RADIO-CRAFT:

I enjoyed the article by Mr. John D. Adams in the April, 1932 issue of RADIO-CRAFT, page 609, in which Mr. Adams describes the use of a type '71A or '01A tube in place of ear phones.

I have worked along somewhat similar lines and have an experiment in mind which may interest other readers. The effect is almost uncanny as the radio receiver seemingly operates without the use of a loudspeaker.

For this experiment I used a standard 5 tube, T.R.F., battery-operated receiver. After tuning in a loud station and disconnecting the reproducer from the output terminal, I took a flash light bulb (even a 40 watt electric light bulb may be used) and connected its two terminals to the loudspeaker terminals of the receiver and thereby obtained surprisingly good loudspeaker operation. The idea is illustrated in Fig. 1. Although the reproduction sounds more like a pair of headphones it can at times be heard throughout the room.

Surely there must be other experiments which have not come to light and I look forward to hearing from others who may have something interesting to report.

JOHN KLASE,
R. F. D. No. 1,
Macungie, Pa.

TO INTERFERE OR NOT TO INTERFERE

Editor, RADIO-CRAFT:

In glancing over my issues of RADIO-CRAFT, I came across an article entitled, "Spark Coil Tone Generator." This article, in the May, 1932 issue of RADIO-CRAFT, page 677, had previously escaped my notice.

The publication of such a device as described by Mr. Carter is a discredit to your knowledge of radio. Having been a radio interference specialist for several years, I can readily recognize that this device is capable of causing unlimited radio interference. Imagine what it would do if used in a large apartment house. It is not even much good for the purpose described, considering that an audio oscillator gives a much nicer note, is easily constructed and would interfere with no one.

On the whole, your magazine is fine. Please publish some practical data on five-meter work by American experimenters but don't publish any more stuff like

IMPORTANT NOTICE

In the interest of those readers who do not like to mutilate this magazine, we have asked our advertisers not to place coupons in their advertisements.

Instead of the usual coupons, you will find a number of convenient post cards inserted between the last page and the back cover of this magazine.

This new service will save you time and work. No need to cut coupons, nor is it necessary to hunt for and address envelopes. Moreover, the space for your name on a coupon is usually so small that the advertiser is often not able to make out your writing and then you wonder why you do not get the literature sent for.

Then, last but not least—the postage for a postal card is only 2c whereas a letter now costs 3c.

Read the advertisements and then turn to the page containing the special postal cards. Detach, fill out and mail the card of the advertiser whose literature or offers you want to have sent to you.

Mail your card today! Show the advertisers that you appreciate their cooperation and thoughtfulness.

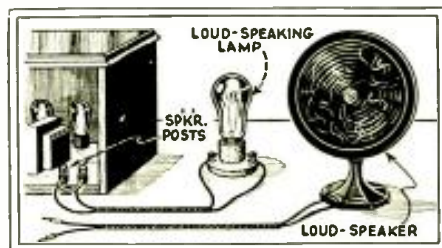

Fig. 1
A novel experiment.

a Spark Coil Transmitter or the wrath of broadcast listeners may be loosed on some hapless amateur who would be foolish enough to try it out.

CHARLES W. CARTER, Box 1573,
Universal Laboratories,
University, Va.

(We were quite aware of the pros and cons of the subject discussed by Mr. Carter and consequently we believe that in printing below the viewpoints of the author of the article in question, that other factors are interestingly brought to light.—Editor.)

MR. BRAINARD replies:

Although I should say that it appears from this letter that Mr. Carter is looking for some free advertising, I am however

writing a few lines in reply to his communication as there may be other readers of RADIO-CRAFT who did not at first see all of the factors in mind when the article was written.

I must take issue with Mr. Carter on the subject of the amount of interference caused by the "Spark Coil Tone Generator," if it is connected as described, as it is almost identical with the ignition system as used in a Model T Ford, after interference suppressors have been added to the ignition circuit to allow reception of programs when an automobile radio has been installed in the car.

An automobile radio is built to have very high sensitivity because of its small aerial, and it is operated from the same source as the ignition system, as far as the "A" supply is concerned; so if the coil does not cause interference in an interconnected circuit such as the one mentioned above, I see small chance for it to cause much interference in an apartment house, especially in view of the fact that it is supposed to be operated on about 4 volts, which is only about one-fourth of its normal operating potential.

I would like to know what Mr. Carter calls the Spark Coil Tone Generator other than a buzzer-driven audio oscillator. Perhaps an audio oscillator using a vacuum tube, audio transformer or its equivalent, and various condensers and an "A" and "B" supply would give a nicer tone, but even that is open to question.

Finally, this article was composed with the idea in mind that there were many people, principally boys, who had neither the money nor the technical knowledge to construct a vacuum-tube audio oscillator, but who had, or could easily obtain, a spark-coil; as for the resistors and condensers, they only cost a few cents apiece. The total outlay for batteries, headphones, etc., should not exceed from two to three dollars, even if it were necessary to purchase everything.

CAL BRAINARD,
79 E. Highlands,
Sierra Madre, Calif.

THE LAST OF THE MOHICANS

Editor, RADIO-CRAFT:

After reading the contributions entitled "One on Us," and "Who Killed Cock Robin," in the July, 1932 issue of RADIO-CRAFT, it occurred to me that I might be able to give you some authentic information.
(Continued on page 305)

RADIO-CRAFT'S INFORMATION BUREAU

SPECIAL NOTICE TO CORRESPONDENTS: Ask as many questions as you like, but please observe these rules:

Furnish sufficient information, and draw a careful diagram when needed, to explain your meaning; use only one side of the paper. List each question.

Those questions which are found to represent the greatest general interest will be published here, to the extent that space permits. At least five weeks must elapse between the receipt of a question

and the appearance of its answer here.

Replies, magazines, etc., cannot be sent C. O. D.

Inquiries can be answered by mail only when accompanied by 25 cents (stamps) for each separate question.

Other inquiries should be marked "For Publication," to avoid misunderstanding.

CONSTRUCTING A 6-TUBE CAR RADIO—UNTUNED R. F. TRANSFORMERS

(177) Mr. Powell E. Fargo, Winchester, Ill.
(Q.1) Is it possible to use the Wunderlich tube in an automotive receiver? What would be the necessary circuit changes to obtain operation in a standard car radio set, using this type of tube in place of the more standard detector?

(A.1) To obtain best operation from the Wunderlich tube it is advisable to carefully match its load requirements. This will necessitate the use of certain units having special characteristics. Perhaps the most simple circuit arrangement along this line is the super-heterodyne illustrated in Fig. Q.177A. (This design is published by courtesy of Mr. H. G. Cisin.)

To obtain best results it will be advisable to use exactly the components specified for this particular circuit, otherwise it will be difficult to obtain the high gain which must be secured for satisfactory operation in an automobile.

List of Parts

- One Electrode volume-control potentiometer, type R1-203, 27, with power switch, 32;
- One Electrode 2,000 ohm Trivolt wire grid resistor, 6;
- One Cardwell two-gang dual variable condenser, type 217-C, 350 mmf. per section, 4, 12;
- Two Aerovox .001-mf. mica-insulated condensers, type 1460, 9, 13;
- One Aerovox .006-mf. cartridge type condenser, type 281, 21;
- One Aerovox .05-mf. metal case type condenser, type 260, 18;
- One Aerovox .1-mf. cartridge type condenser, type 281, 7;
- One Aerovox .5-mf. metal case type condenser, type 260, 24;

- One Trutest A.F. transformer, type 2C1550, 26;
 - One Trutest, 175 kc. I.F. transformer, type 2H 10096 "S", complete with two 7-140 mmf. trimmer condensers, 16;
 - One Special I.F. transformer, with 7-140 mmf. trimmer condensers, same as 16 but with secondary center-tapped, 17;
 - One Trutest oscillator coil, type 2H 10074 and shield, 8;
 - Six 5-prong wafer-type sockets, 5, 15, 20, 23, 28, 29;
 - One Premier Conoid shielded antenna coil, 3;
 - One Premier steering column remote-control unit with universal coupling and flexible connector cable;
 - One Sheet-iron battery case;
 - One I.R.C. Durham 1 meg., 1/2-watt Metallized resistor, type MF4 1/2, 22;
 - One I.R.C. Durham 50,000 ohm, 1 watt Metallized resistor, type MF1, 25;
 - Two I.R.C. Durham 50,000 ohm, 1/2-watt Metallized resistors, type MF4 1/2, 14, 19;
 - Three small trimmer condensers, 2 to 35 mmfs., 4A, 10, 11;
 - One Automotive-type Amperite, type 18-1, 33 (Note: If not readily obtainable, a type 227 Amperite may be substituted.);
 - Two Arceturus 136-A auto screen-grid tubes, 5, 20;
 - One Arceturus 137-A auto oscillator tube, 15;
 - One Arceturus Wunderlich type "A" or "B" Auto tube, 23;
 - Two Arceturus 138-A auto pentode tubes, 28, 29;
 - Four binding posts, ST 187, 1, 2, 30, 31;
 - Three 45-volt Auto "B" batteries or Auto "B" eliminator;
 - Three 4 1/2-volt "C" batteries;
 - One No. 12 gauge aluminum chassis, size 12 x 8 x 2 1/2 in. high, 12 x 8 x 2 1/4 in. wide;
 - One Wright-DeCoster vehicle speaker, equipped with 7,500 ohm impedance output transformer, 34;
 - One 1/2-Amp. Instrument Littelfuse, No. 1004;
 - One Littelfuse Gryp connector, No. 1039.
- (Q.2) Please furnish constructional details for an untuned R.F. transformer design suitable for use with triodes and screen-grid tubes.

A transformer of this type is specified for use in the article, "Building a 1930 Electric Receiver," in the November, 1929 issue of RADIO-CRAFT. The construction data given in the article does not seem to "click."

(A.2) In the first place, an untuned R.F. transformer designed to match circuits incorporating triodes is not suitable for combinations incorporating screen-grid tubes. Secondly, a great improvement in operation of the "1930" set may be obtained, as stated in past issues of RADIO-CRAFT, by using a manufactured, untuned R.F. transformer.

However, construction details for such a design are given in Fig. Q.177B. The "catch" lies in the use of a special grade of core material referred to as "R.F. iron"; note that 100 laminations must be fitted into a space of 1/4 in. in order to obtain high gain and flat response over the broadcast band.

For triodes, the primary is wound with 115 T, No. 38 enam. wire, in a single layer, on a tube 9/16-in. dia.; the secondary is similarly wound to a total of 170 T. For screen-grid tubes, increase the number of primary turns to about 135; the secondary remains the same. The tubes may be made by winding about 5 layers of paraffined paper around the core.

A.V.C. IN PHILCO "TRANSITONE 7" —ELKONODE FILTER CIRCUIT— "IMPROVING AN AUTO RADIO"

(178) Mr. George A. Parkinson, Dubuque, Ia.
(Q.1) Although the claim is made, in the September, 1932 issue of RADIO-CRAFT, pg. 167, that the Philco "Transitone 7" automotive receiver incorporates automatic volume control, the manner in which this action is obtained is not clear to me; also, all available references on this point do not seem to help any. Please advise whether A.V.C. is really obtained in this model set, and just "how" it is accomplished.

(A.1) Through the courtesy of Mr. Robert Long, Jr., Service Manager, Transitone Automobile Radio Corp., the following detailed explanation of the action in the A.V.C. portion of the Transitone 7 chassis is available.

The incoming I.F. signal is converted or rectified by the second-detector, V4, into an A.F. signal. While this is being accomplished, a D.C. voltage is developed from grid to cathode which is proportional to the strength of the carrier voltage.

This D.C. voltage is fed back to the control-grid circuit of the first tube, V1. The two 90,000-ohm resistors in series form a voltage divider so that the voltage fed back at the mid-point is one-half the voltage developed. This is carried to the I.F. amplifier, V3.

These voltages from the detector circuit, as stated above, are proportional to the carrier voltage and are applied to the control-grids of the R.F. and I.F. tubes, controlling the amplification in these tubes. The greater the signal strength, the greater the voltage impressed on the grids and consequently, the lower the amplification. This governor-like action is automatic and through the use of the correct "time circuit" resistors and condensers, is prevented from oscillating and hence is very smooth.

In addition to being a part of the time circuit, the resistors immediately connected to

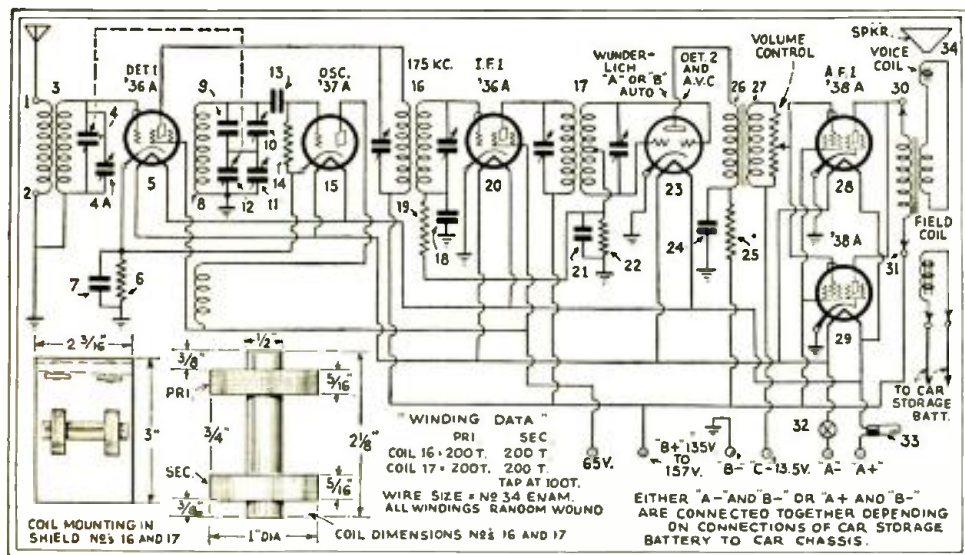

Fig. Q177A

Schematic circuit showing the use of the Wunderlich tube. The load impedance must be matched.

the low-potential ends of the antenna coil and I.F.T. 1, are bypassed by condensers, block the R.F. and I.F., thus keeping them from backing up into the receiver.

(Q.2) In the article, "An Automotive 'B' Eliminator," in the September, 1932 issue of RADIO-CRAFT, appears a schematic circuit which shows only a "box" for the tuned filter section of the Elkonode interrupter. Is it possible for you to show the actual connections within this portion of the "B" supply unit?

(A.2) In Fig. Q178 is shown the schematic circuit of the tuned filter of the Elkonode.

(Q.3) The writer has constructed a set in accordance with the article, "Improving an Auto Radio," in the March, 1932 issue of RADIO-CRAFT. However, a whistle has developed which it is very difficult to eliminate. What could be the trouble; also, is it advisable to use a particular type of antenna with a set of this type?

(A.3) These questions have been brought to the attention of the author of the article, who has furnished additional data on the points in question.

Eliminating a Whistle

A possible objection, revealed in studying the detector circuit, is the screen-grid's connection directly to the cathode. This was found necessary for the elimination of a persistent whistle which could not be eliminated either by changing the plate and cathode resistors or using heavy bypassing.

The prime cause of this, suspected by the author, is that the plate and screen-grid voltages, with a strong signal on the control-grid at times, approach each other too closely.

This is the result of the tube being worked on the lower bend of its curve and with a high plate-load resistance so that a strong signal input results in very wide plate-voltage fluctuation. It is suggested that this whistle could be the result of a secondary emission but how this could be possible with currents in the tube in the order of 1/4 ma. or less is hard to see.

It is, of course, obvious that to lower the value of R8, raise that of R7, or do both, would increase the plate voltage and thus obviate a howl due to the cause outlined and make possible a slight positive bias on the screen-grid. This undoubtedly would increase the volume but would tend to decrease the tone fidelity and is thus a matter of compromise with the individual builder.

A point not apparent from the schematic diagram is that, in some cars, it is the positive terminal of the storage battery that is grounded. When this is the case, the connections to the terminals A- and A+ should be reversed within the set, or else the car's battery will be short-circuited upon connection of the set. Although it should be borne in mind that in the type '36, '37, and '38 tubes, as in any indirectly-heated cathode tubes, this polarity reversal is immaterial, this variation in battery-grounding practice makes it important that care be taken to insert the "on-off" switch in the ungrounded "A" battery lead.

A Convenient Car Antenna

As to antenna systems for use in cars, the author is partial to a method which involves pasting about 100 or 150 feet of thin copper ribbon to the car top and then covering the crisscross latticework with a layer of insulating varnish. Of course, a layer of this insulating varnish precedes the laying down of the copper ribbon and at all points care must be taken to insure that the ribbon is not short-circuited to the car body.

For a ground, the car frame itself is used; although, a sheet of copper on the underside of the car laying across the car's width, from running board to running board, might improve results. It would be interesting when trying such a ground plate to insulate the plate from the car body proper and to break the ground connection of the primary of L1, carrying the antenna primary coil's ground lead directly to the plate.

A final recommendation to the builder is that the outside leads from the set, with the exception of the antenna and ground leads, be shielded in flexible mesh or in "condulet," and that this shielding be grounded. Individual

shielding should be used for the volume-control leads, for the battery leads ("A" and "B" in the same shield), and for the horn leads.

THE TELEKTOR

(179) Mr. Charles Farrish Cox, Oakland, Cal.

(Q.1) In the May, 1932 issue of RADIO-CRAFT is described the Telektor remote control unit. Please describe the action of the "silent" key used in this system.

(A.1) After the motor unit is attached, there are three possible positions of the "SILENT KEY" knob on the radio receiver.

(a) When pushed all the way in, this key "mutes" or silences all loudspeakers;

(b) When pulled all the way out, it engages the gears and switches for remote control;

(c) When in its neutral or center position, it disengages these gears and switches to permit manual control of the receiver and phonograph.

If a phonograph relay has been installed in the receiver, press the "RADIO" button in any Telektor box before going to the receiver to take manual control. While manual operation in the receiver is taking place, all the regular controls on the radio receiver must be used.

(Q.2) Please describe the installation procedure concerning the Telektor.

(A.2) As with all attachments there may be some adjustment necessary when installing a motor unit for the first time in order to drive the volume control or the tuning dial to both ends of their travel, and in order that the "SILENT KEY" shaft may slide in and out freely. The initial installment of the motor unit on any chassis should be performed by a dealer's Service Man who has been given definite instruction on how to make any installation he advises necessary. Once the attachment has been made, however, the motor unit may be removed for occasional lubrication or inspection by anybody. Care should be taken to see that the dial is turned to the "55" channel (550 kc.) when removing a motor unit from a receiver.

The motor unit should be mounted on the chassis as follows:

(1) remove the dust cover from the Motor Unit. (Replace the Motor Unit tuning knob on its shaft after doing so);

(2) turn the radio dial to the 550 kc. end of the scale;

(Note: On the Concealed Type Receiver, turn the counterweight so the slot milled in it points vertically upward.)

(3) turn the radio volume-control all the way down to zero (thereby throwing the phonograph switch);

(4) hook a stout rubber band from the volume-control knob to the "ON-OFF" switch knob in such a way that it presses in on the silent key knob in passing;

(5) now turn the radio set around and remove the back of the cabinet;

(6) remove the A.C. supply cord;

(7) turn the tuning crank of the Motor Unit so that it points upward;

(8) turn the volume crank so that it points downward;

(9) push in the tuning knob of the Motor Unit;

(10) pick up the Motor Unit and place it in position on the back of the chassis. The only trick to this is to be sure that the extension of the tuning knob shaft of the Motor Unit engages in the coupling on the "SILENT KEY" shaft of the radio receiver. Approach the chassis with the Motor Unit held a little too low. Then when this shaft extension is entered with the chassis opening, raise up the Motor Unit until the centering pin on the tuning crank enters the hole in the end of the gang condenser shaft;

(11) fit the Motor Unit mounting screws and lock washers and thread them loosely into their brackets;

(12) holding the Motor Unit in approximate position, push in and pull out on the tuning knob and move the Motor Unit until this knob moves freely. Then tighten up the mounting screws;

(13) connect the cord "R" from the Motor Unit into the receptacle "S" of the radio receiver chassis;

(14) connect the short A.C. supply cord from the Motor Unit to the A.C. input receptacle of the chassis;

(15) replace the dust cover on the Motor Unit, fastening it by its five screws;

(16) connect the flat plug on cord "K" from the Motor Unit dust cover to jack "J" of the chassis;

(17) place the Motor Unit tuning knob on its shaft and connect the A.C. supply cord;

(18) make sure that the tuning knob of the Motor Unit is pushed in as far as it will go (to engage the gears for remote control);

(19) insert the Control Connector plug of a portable type Telektor Box or of a connector cord to either jack receptacle in the back of the motor unit;

(20) connect the flat meter plug from this Telektor Box or connector cord into either of the meter jacks in the left hand edge of the dust cover;

(21) connect the three-wire polarized cap from the Master Speaker Relay (if used) to the lower three wire polarized receptacle on the Motor Unit;

(22) connect the three-wire polarized cap from the Phonograph Relay (if used) to the upper three-wire polarized receptacle in the Motor Unit.

If the Motor Unit is replaced on the radio receiver chassis in the same relative position that it originally occupied, it will be found that the settings of the brushes for the eight favorite stations will still be accurate. A slight change in relative position will necessitate a slight readjustment of the brushes, in order to secure accurate tuning and best tone quality.

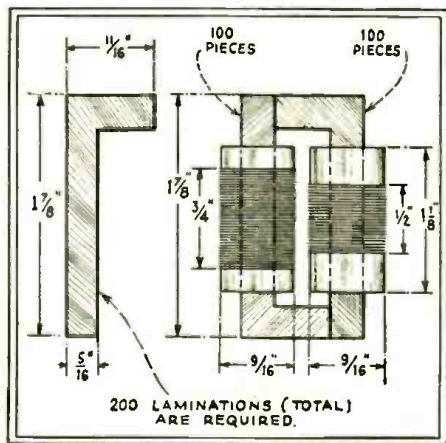

Fig. Q177B
Construction details of an untuned R.F. transformer.

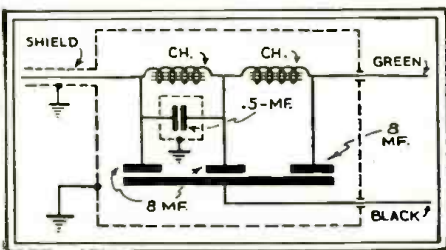

Fig. Q178
Schematic circuit of the Elkonode.

REGARDING SONORA SETS

Concerning Q. No. 128, page 102, August 1931 issue of RADIO-CRAFT, Mr. Lemuel E. Randall, 3343 So. Richmond St., Evergreen Park, Ill., comments as follows, concerning changes in certain Sonora models.

Both filament-circuit coils are either removed or shorted out; the .3725-ohm resistors are removed. Thus, the R.F. circuits are no longer neutralized; 500-ohm grid suppressors are used. The center-tapped V4 filament resistor may measure 30 ohms; the other one may be 15 or 30 ohms.



PRICE

Some tubes are sold on low-price alone. Where price is the whole consideration, we can't possibly hope to sell Certified TRIADS, the Double-Checked Tubes, with an engineering pedigree accompanying each tube. The TRIAD certification slip assures the purchaser of positive satisfaction and the dealer of a real profit. In quantities, the discount is 50% to TRIAD Dealers and Servicemen.

QUALITY

Certified TRIAD Tubes are of superior and regular quality. They are all right up to a very high standard. The engineering slip which is sealed in with each tube assures you of absolute satisfaction with a real guarantee. Our story in a nutshell is "there are no better tubes that Certified TRIADS."



PREMIUMS

We are now able to make another striking introductory offer. By an arrangement with the publishers we now offer a handsome copy of the popular 1933 Official Radio Service Manual, list \$5.00; the 1932 Official Radio Service Manual, list \$5.00; the 1931 Official Radio Service Manual, list \$4.50; S. Gernsback's Radio Encyclopedia, list \$3.98, with each Dealer's or Serviceman's initial order of \$40.00—\$20.00 net. It is highly desirable for all Servicemen to have a complete file of all these manuals. Read the publishers' advertisements which tell you all about them, then send in your first order for



CERTIFIED TRIAD TUBES

The TRIAD Line is complete. It includes all types of standard Tubes as well as Photo-Electric Cells Television Tubes.

CERTIFIED TRIAD TUBES are licensed by RCA, and are sold at the same list prices.

TRIAD MANUFACTURING CO. Pawtucket, R. I.

My money order or check for \$20.00 is attached. In return, I want the CERTIFIED TRIAD TUBES listed from the regular TRIAD TUBE list amounting to \$40, less 50% discount. I am also to receive, ABSOLUTELY FREE, the manual checked below:

- 1931 OFFICIAL RADIO SERVICE MANUAL.
- 1932 OFFICIAL RADIO SERVICE MANUAL.
- 1933 OFFICIAL RADIO SERVICE MANUAL.
- S. GERNSBACK'S RADIO ENCYCLOPEDIA.

Name

Address

City..... State.....

My letterhead or business card is attached

Latest Tubes at New Low Prices!

So many of our customers have taken advantage of our bonus that we decided to extend this offer

Take advantage of our offer—25 UY-227 Tubes FREE with every purchase of 100 assorted tubes.

Give to your customers the advantage of buying first-quality licensed R.C.A. tubes at prices that are exceptionally low. We carry the largest variety of tubes in the world, many for special purposes, and every tube is replaceable within three months, providing the filament is not burnt out. We either have the tube you require or we will make it for you.

COMPLETE STOCK READY FOR IMMEDIATE SHIPMENT

Order from this page—Remit 20% with order, balance C.O.D. All prices are F.O.B. FACTORY, Newark. Shipments go forward express or parcel post. No order for less than \$5.00 accepted.



TYPE O
Potassium
Photo Cell, 4"
overall, \$2.10



TYPE V
Television Tube
1 1/2" square
cathode, over-
all size 2"x6",
\$3.85



TYPE R
Caesium Photo
Cell, overall
length 3-1/16",
\$5.90.

TYPE	ANY QUANTITY	PRICE
UX-201A	—Amplifier or detector	\$.30
UX-226	—AC amplifier	.30
UY-227	—AC amplifier or detector	.30
UX-171	—Same characteristics as 171A on tungsten filament, 1/2 amp.	.30
UX-171A	—Power output amp. for AC or DC operation, 1/4 amp.	.30
UX-240	—Designed for impedance and resistance coupling	.40
UX-120	—Power amp. used in last stage of audio freq.	.40
UX-199	—Detector and amp. tube, long prongs	.40
UV-199	—Standard base, has a 201A base, same characteristics as 199	.40
UV-199	—Same characteristics as UX-199, only short prongs	.40
UX-112A	—Power amp. tube for low cur. consump., 1/4 amp.	.40
UX-112	—Power Amp. 1/2 amp.	.40
UX-200A	—Detector tube recommended for weak signals	.40
UY-224	—AC screen grid amplifier	.40
UX-245	—Power amplifier	.40
UX-201B	—1/3 Amp. Amplifier and Detector	.60
UY-246	—Power Amplifier Pentode	.60
UY-247	—Power pentode	.60
WD-11	—Detector Amp.	.60
WD-12	—Detector Amp.	.60
UX-230	—Dry cell amp. and detector, 2 volts	.60
UX-231	—Dry cell amp.—last audio stage, 2 volts	.60
UX-232	—Dry cell screen grid amp., 2 volts	.60
UY-233	—Power Amplifier Pentode, 2 volts	.85
UX-234	—Screen Grid Pentode R.F. Amplifier	.85
UY-235	—Super control screen grid amp.	.60
UY-236	—Screen Grid Radio Freq. Amp.	.85
UY-237	—Detector Amplifier	.85
UY-238	—Power Amplifier Pentode	.85
UY-239	—10" R.F. Pentode Amplifier	.85
UY-551	—Variable Mu	.60
UY-56	—A.C. and R.F. Amplifier and Oscillator	.60
UY-57	—6 prong Screen Grid R.F. Amplifier and Detector	.60
UY-58	—6 prong Variable Mu R.F. Amplifier and Super Detector	.60
UX-210	—For power amplifier, high voltage	1.10
UX-212	—Screen grid radio frequency amp.	1.10
UX-250	—Power amp. used in last stage of audio freq.	1.10
	Ballast tube to prevent tubes in set from blowing out	1.10
	Special super-sensitive Audio Freq. 201A	.60
	Special super-sensitive Radio Freq. 201A	.60
	Special 171 AC 1/2 amp. extra coated filament—good for electric sets	.60
	T-14 (201A High Mu) high emission	.60
	Switch tube, 201A or 112 or 171 double life	.60
	Adapter tube 226, 227, 171A, to convert bat. sets to AC, each	.60
	UY-227A—AC amplifier or detector, same as 227 (but quick heater)	.60
	UY-224A—AC screen grid amplifier, same as 224 (but quick heater)	.60

RECTIFIER AND CHARGER BULBS

125 Mill. rectifying tube (R. II.) (Raytheon Type)	1.25
6/10 amp. triekle charger bulb (Tungar Type)	2.00
2 amp. old and new type charger bulbs (list \$4.00) (Tungar Type)	2.00
5 and 0 amp. charger bulbs (list \$8.00) (Tungar Type)	3.75
15 amp. charger bulbs (Tungar Type)	7.50
UX-866—Hot Cathode Mercury Vapor Half-Wave Rectifier (Heavy Duty)	2.75
UX-280M—Hot Cathode Mercury Full-Wave Rectifier same as UX-588	1.25
UX-281M—Hot Cathode Mercury Vapor Half-Wave Rectifier	1.90
UX-871—Hot Cathode Mercury Vapor Rectifier	1.25
UX-280—Full-Wave Rectifier for High Emission	.40
UX-281—Half-Wave Rectifier	1.10
UX-282—Full-Wave Mercury Vapor Rectifier	1.10

PHOTO CELLS

Photoelectric cell, "Potassium" Type O	2.10
Photoelectric cell, "Caesium" Type A, 1 1/2" overall length	7.90
Photoelectric cell, "Caesium" Type R, 3 1/16" overall length	5.90

TELEVISION TUBES

Tellon Reflector Neon Television Tube, 1" Cathode Square Type C	3.85
Tellon Neon Television Tube, 1 1/2" Cathode Square Type V	3.85
Tellon Neon Television tube, 1" Cathode Square Type X	2.10

UX-182—Sparton Type	.85
UX-183—Sparton Type	.85
UX-484—Sparton Type	.85
UX-585—Sparton Type	2.10
UY-686—Sparton Type	.85
UX-401—Kellogg Type	1.50
UX-403—Kellogg Type	2.00

ARCO TUBE COMPANY, 40 Park Place, Newark, N. J.

AN EXPONENTIAL RULE

To simplify methods involved in the solution of engineering problems and the plotting of curves containing exponential functions there has been developed and copyrighted by Louis B. Sklar, a 7-scale rule, a portion of which is shown in Fig. 1. It measures, in one model, 1 1/2 x 11 in.

This rule also aids materially the solution of problems involving roots and powers of numbers less than unity.

Divisions of Scale G of this new rule are arranged in proportion to the logarithms of numbers to the base e, just as on the common slide rule the scales are founded on the base 10.

The effective length of Scale G is 50 in., which increases considerably the accuracy of the results obtained in using this rule.

The problem of locating decimal points in the final result has been solved by placing guiding figures on the right-hand edge of the rule to indicate the number of digits found either to the right or left of the decimal point. All mental work in this respect has thus been eliminated.

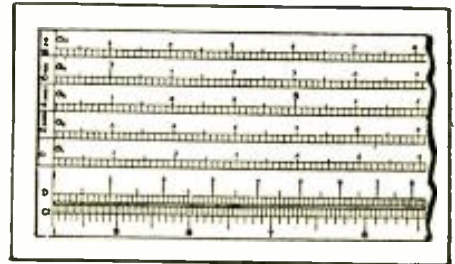

Fig. 1

I. R. C. GRID-BIAS KIT

THE International Resistance Co. has just placed on the market a grid-bias kit of resistors containing the necessary units for properly biasing 24, 26, 27, 71A, 10, 15, 50, and 47 tubes.

There is an information folder enclosed with each kit pictured in Fig. A which gives the proper resistance value for the correct biasing of the above-mentioned tubes.



Fig. A

PHILCO WRENCH KIT

THE new Philco wrench kit is one of the most convenient aids for the Service Man that has been designed in a long while. The kit consists (Fig. B) of four socket wrenches of the proper size to fit all types of hex-head bolts, nuts, and drive screws used in Philco sets.

These wrenches are especially hardened and should not be confused with ordinary cheap socket wrenches which wear quickly when used with the extremely hard Parker-Kalon drive screws.

Another feature is the fact that the wrench handles are hollow and are equipped with screw caps, providing space for the wrench sockets.



Fig. B
New Philco wrench kit.

On Page 306 of this issue will be found an important announcement which gives full details about the new 1933 OFFICIAL RADIO SERVICE MANUAL. Turn to this page NOW and read the advertisement carefully.

Write
Today
for
Information
on
This

AUTO-DIAL RADIO

Quality, tone, selectivity, and power

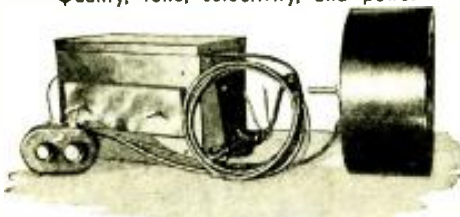

Sensational
AUTO
RADIO

COMPLETE \$39.20—includes set, volume control, suppressor kit, tubes and dynamic speaker. Set only \$17.65. Dealers wanted. Write today.

J-M-P MANUFACTURING CO., INC.
3359 Fond du Lac Ave., Milwaukee, Wis.

QUASI-OPTICAL HOME EXPERIMENTS

BUILDING A PHOTO CELL AMPLIFIER

By John B. Brennan, Jr.

There are any number of simple experiments which you can conduct by yourself in this field. They were briefly outlined in the introductory article of this department appearing in the October, 1932 RADIO-CRAFT.

The pieces of apparatus which are needed for this experiment are: One—a photoelectric cell; two—an audio amplifier; and three—a loudspeaker or milliammeter.

It is hardly possible to construct a cell unless elaborate tube-making machinery is available. It is better that this item be purchased. The audio amplifier is quite simple to build and requires only a few parts, many of which the experimenter will find in his junk box. They are, transformers, resistors, mica condensers, tube sockets, binding posts, and wire. The circuit of the amplifier is shown in these columns. The arrangement of the parts is simplicity itself, and closely follows the arrangement shown in the circuit diagram.

The photo cell is connected to the input terminals of the amplifier, "a" and "b," while the loudspeaker or milliammeter is connected to the amplifier's output, "c" and "d."

If a source of light, say from a flashlight, be shone on the photo cell, a loud "plop" will be heard in the loudspeaker. If a milliammeter is used, a rise of current will be indicated. Now, if some means be employed to rapidly interrupt this light beam before it impinges on the surface of the photo cell, the frequency at which the interruption takes place will manifest itself in the loudspeaker by a noise of the frequency of the interrupting device. For instance, let's use an ordinary household electric fan. Its speed, or number of revolutions per minute is in the neighborhood of some 1,800. Since there are four blades to the fan the source of light will be interrupted some 7,200 times per minute, or 120 times per second, producing a low, audible note or tone in the loudspeaker.

Other experiments along this line may easily be tried. For instance, a cardboard disc can be substituted for the fan. In the disc, at equidistant points, holes may be made through which the light source may be made to shine onto the photo cell. If, say twelve holes are equally spaced around the edge of the disc, then the frequency of the tone emitted by the loudspeaker will be 360 cycles. The formula by which the frequency of the tone may be determined is F equals $(S \times N)$ divided by 60, where F is the frequency of the tone in cycles per second, S is the speed of the motor in R.P.M. and N is the number of holes or interruptor units.

The values of the parts used in the amplifier whose diagram is shown here are: T1, high-ratio audio transformer; R1, 0 to 50,000-ohm potentiometer; R2, 200,000 ohms; R3, 2 meg-ohms; R4, 2,500 ohms; C1, .01-mf.; C2, .1-mf. A '24 tube is used in the first stage while a '27 tube is used in the output stage.

For additional information on the use of the
(Continued on page 369)

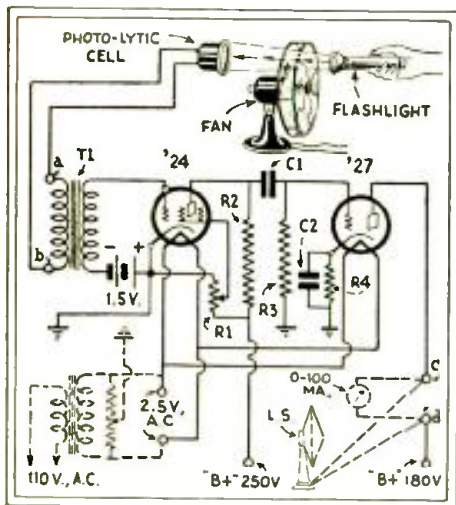

Made to order for
the Service Man—

We've put ourselves in your place and brought out everything you need . . .

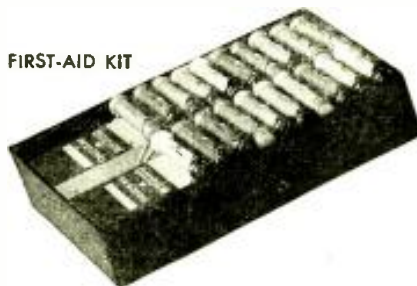

FIRST-AID RESISTOR KIT

Handy pocket size kit furnished in two different types —1-watt kit containing 20 Ohiohm resistors, ranging from 250 ohms to 2 megs.; 2-watt kit containing 10 Ohiohm resistors, ranging from 500 to 50,000 ohms.

Value stamped on each unit

Each Ohiohm resistor, in addition to being color coded according to R.M.A. standard, has the actual value stamped on each piece.

FREE

The following three items are given free with initial order of First-Aid Kit:—

OHM DIAL Instantly tells the resistance value in ohms of any resistor in the sets you service, when the resistors are color coded according to R.M.A. standards. Regular price, 50c each.

GUIDE A simplified and ready means for determining the correct model, resistance value and number of resistors to be used in most popular sets.

LABELS to help get you further service. Each First-Aid Kit contains a supply of labels to place in the back of the set, which, in addition to recording the work done, secures further service because your name and address appears on the label.

OTHER ADVERTISING HELPS FREE

SPARK SUPPRESSOR SETS

... for eliminating ignition interference on AUTOMOBILE RADIOS

Are you going after this new, rich field of business? Ohiohm Suppressor Sets supply you with the condensers and spark suppressors to meet all usually encountered conditions of automobile radio installations.

• Write for prices and details •

THE OHIO CARBON COMPANY
12508 BEREA ROAD CLEVELAND, OHIO

OHIOHM RESISTORS are made in Canada by
C. C. Meredith & Co., Ltd., Toronto



ELECTRICAL ENGINEERING

BOOKS SENT FREE

New Edition Containing 100 Pages

A-C RADIO!

We're glad to send a set to your home to examine and use as your own for 10 days—to show you that here is the most up-to-date and complete work on Electricity ever published. Written by CROCKER of Columbia U., MILLIKAN of Calif. Tech., HARRISON of General Electric and 26 other noted Electrical Engineers. Starts off with elementary Electricity in simple, non-technical language for the beginner and includes every Engineering branch for use of experts on the job.

8 FLEXIBLE MAROON VOLUMES
4300 pages, 3200 illustrations, deluxe gold stamped binding. Index in each book, general index in Vol. 8. Covers every subject in Electricity: Light, Power, Transmission, Generators, Motors, Switchboards, Radio, Telephone, House Wiring, Railways, etc.

Complete Electrical Reading Course

Electricity, the biggest industry in the world, continues to grow the most rapidly. And it offers better jobs, bigger salaries and a brighter future than any other field. Every dollar, every hour invested in learning Electricity will come back to you a thousand-fold. Learn in spare time with these books at one-fifth the cost of trade courses. Outline for organized study, quiz-questions and a year's free consulting membership in the American Technical Society included without extra cost, if you mail coupon immediately.

LOOK IT UP!

Thousands of these sets are used as REFERENCE books by men employed in electrical, building construction and allied lines. The JIFFY INDEX puts the answers to 20,000 questions right at your finger tips.

AMERICAN TECHNICAL SOCIETY
Dept. E-626
Drexel Ave. & 58th St., Chicago

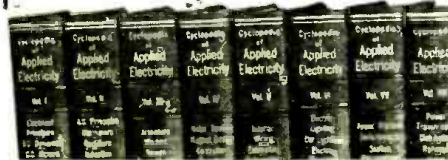

AMERICAN TECHNICAL SOCIETY
Dept. E-626, Drexel Ave. & 58th St., Chicago
Please send for 10 days' free trial 8-volume set of Electrical Engineering just off the press, subject to return if I wish to. (I pay the few cents express charges on receipt of books, you pay express if returned.) If I decide to keep them, I will pay \$2.00 after 10 days' trial, then \$3.00 a month until \$34.80, special advertising price, is paid, after which books become my property. Year's Consulting Membership to be included free.

Name

Address

Employed by

Employer's Address

DYNAMIC Radio

PENTODE

Build this powerful radio yourself. Simple directions. Beautiful Walnut Cabinet, 4 R.C.A. licensed tubes, Dynamic speaker—Everything furnished—nothing more to buy.

\$10.95
Tax and Postage Paid



COMPLETE with ALL PARTS

Range 200 to 1000 miles without aerial. Covers band 175 to 550 meters. Gets Police calls. Light socket A.C. 110 volt operation. Size 12 x 7 x 6"; weighs 10 lbs. Send \$2 deposit. Balance \$8.95 C.O.D. Order a "Build-It" Kit Today.

MY OWN RADIO, Inc., Dept. RC
1800 Grace Street Chicago, Ill.

RADIO'S REWARDS



are rich for those who are prepared. Study all branches of practical radio at RCA Institutes, America's oldest radio school. Resident schools in New York and Chicago. Also extension courses for home study on new "no obligation" enrollment plan. Catalog upon request.
RCA INSTITUTES, Inc.
Home Office, Dept. RT-111
75 Varick St. New York

OVER-THE-COUNTER SUGGESTIONS

By Jack Grand

You get up in the morning feeling mighty ill. You go to the doctor and he gives you a pill. And if that doesn't do much good to you there will be sixteen more new tubes coming through.

And there are sixteen more new tubes to be released before 1932 ends. This means that the Service Man that wants to stay in the radio service field will have to know his business. The screw driver expert of old battery days, the old type of Service Man who used to carry a voltmeter, a battery, and a pair of test leads in his pocket is no longer a figure in the radio service field. The Service Man of today must have a fundamental knowledge of radio and a good testing outfit. It is surprising to note the number of men that come in daily who are eager to purchase radio magazines, service manuals and technical books that will keep them fully informed as to the latest developments.

Believe it or not, some of the manufacturers are coming to the point where they believe it is to their best interest to keep the Service Men posted; in fact, none other than R.C.A. is publishing a tube characteristic book that gives information as to the construction of tubes, the placing of the elements, and their use and application in radio circuits. The nominal charge of 25 cents for this book should make it very popular with all Service Men. Here is hoping that other manufacturers follow the good example of R.C.A.

The Service Man nowadays has to be somewhat of a salesman as well, especially now during the dull period. One of the clever Service Men that drops in quite often tells of a neat stunt that helps him sell hand mikes and eventually better systems. After making the usual tests and replacements he takes a hand mike and adapter out of his tool box and explains that he is going to make an audio test. When the hook-up is completed he makes a few sounds through the microphone, counts to ten. Should the customer appear interested and if there are any children in the room he takes the mike over to one of them and instructs the child to say something, usually "hello daddy, hello Mother," or if no children are available, he allows the customer to make some announcement. In either event the sensation of home broadcasting is such that the customer always asks "How much could I buy one of those things for?" And the prompt reply is "Oh! I'll let you have this one for \$— and I will pick up another one when I go downtown"—more profit on the same call.

Two Service Men that are noted for their activities on D.C. sets came in for some information on T and H pads. After the information was supplied I was tactfully told that the old cash register would not register as far as they were concerned, as there was nothing they could buy. However, to square matters they decided to let me in on one of their pet ideas that they considered pretty good, so here it goes.

Whenever a prospect wants an expensive A.C. set converted to D.C. he usually is very anxious to know how it would sound on 110 V.D.C. before he goes to the expense of changing over. To demonstrate the set, they open the lead in the power pack marked X in the diagram. A 2000-ohm variable resistor (rated at 40-50 watts) is connected into this open lead. The resistor is then varied until a meter that is inserted in the "B" lead of the power tube indicates 100 volts. Then, as the radio is playing, they explain that the set will sound better after the "C" bias is corrected and other adjustments are made.

P.S. The surface has not been scratched yet—all aboard for auto installations.

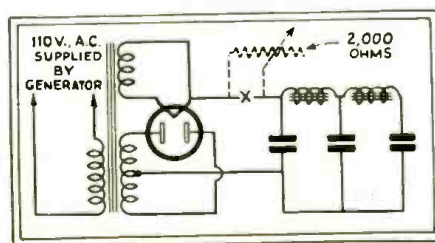

ROUND THE WORLD RECEPTION WITH THE NEW POWERTONE BATTERY OPERATED RECEIVER

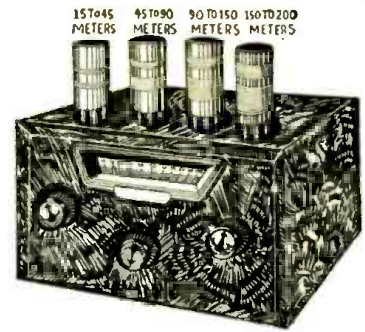

Amazing results on this set will convince you that the utmost in the reception of shortwaves with a battery set has been reached.

The use of the new two volt tubes greatly increases reception, sensitivity, and selectivity, and at the same time, current consumption is kept at a minimum. A 232 screen grid tube and a 233 power Pentode amplifier greatly increases the far-reaching performance of this set.

A Hammarlund condenser is used in the construction of this set as it is the most efficient for shortwave reception.

Install one in your home, store or "lab" and get your share of enjoyment—or increase your business by selling this low-priced shortwave set.

It will tune from 14 to 200 meters.

- Price of set with coils \$9.95
- Set of matched tubes 3.00
- Set of full sized batteries 3.50

Send for Circular on 4-Tube "Diamond of the Air," which uses the new 57-58-47 and 80 tubes. Kit, \$7.45.

Three Stores:

TRY-MO RADIO CO., Inc.

85 Cortlandt Street

178 Greenwich Street 179 Greenwich Street
New York City

SEND IN FOR CATALOG

SERVICE MEN TAKE NOTICE

J. R. Williams, E.E.,* originator and designer of such service instruments as the Supreme Diagonometer, Confidence English Reading Tube Tester, etc., is preparing complete and minute details on the construction and use of all types of service equipment—mostly new inventions. Nothing left out. Measurement drawings and detailed construction.

Within the next few months there will be such releases as Condenser Dielectric Leakage Tester, English Reading Tube Tester, "Resonator," a new method for peaking and aligning, etc.

You get this for \$2.00 a year.

Many months of research and design are behind each release and you will save over \$2.00 on each and every construction.

You will receive detailed construction data on complete large Central Service Station Test Boards. In fact, you will receive one release after another in such complete and concise detail you will be equipped with all necessary knowledge and drawings to build the latest and finest of all radio test equipment.

All of this for 2.00 a year.

You will know the problems to face each device. Nothing to guess about. The first release of an English Reading Tube Tester with all latest tubes is ready for distribution. Way ahead of anything. Next comes a real continuity tester and condenser leakage tester. No guess work as information is complete. Send your \$2.00 now to

J. R. WILLIAMS AND SONS,

519 Palm Street

Little Rock Arkansas
*Chief Engineer, Apparatus Desk Company.

Be sure to turn to page 304 and read the important announcement about the extra pages which have been added to the OFFICIAL REFRIGERATION SERVICE MANUAL.

ELECTROMAGNETIC MUSIC

(Continued from page 270)

ume, by numbers representing units such as decibels; duration, also by numbers representing time units; and quality, by the curves which represent the tones. (Such a system of music writing has been described in the October, 1932 issue of *RADIO-CRAFT*.—Editor)

How Frequencies Are Obtained

The "Gnome," illustrated in Fig. 1 is not an ordinary synthetic type, but obtains its various tone qualities by means of a device operated by the pedal L. This instrument works entirely on the Eremeeff synthesis method of producing musical tones.

This method is an advance of the method based on what is generally known as the "theory of Helmholtz," which combines a fundamental frequency of, for example, 32 cycles, with its first harmonic of frequency 64, its second multiple frequency of 96, its second harmonic frequency of 128, its fourth multiple frequency of 160, etc., into a complex pulsating electric current, which, when converted into sound energy, has a predetermined tone quality, if these frequencies are combined at the correct intensities.

Disadvantages are found in this method. For example, if the fundamental is high in frequency, let us say 4,096 cycles, its harmonics and multiples, if higher than about 12,000 cycles, are not within the range of audibility. This leaves the higher tones comparatively poor in quality, while the lower tones are rich. Low-frequency fundamentals may always carry many harmonics, but this does not hold for high-frequency fundamentals. The Eremeeff system adds to the fundamental, fractions of the first harmonic whose frequencies are in accordance with the tones of one octave of a musical scale.

For example, a fundamental frequency of 32 cycles has a first harmonic frequency of 64; a first fraction of 34; a second fraction of 36; a third fraction of 38; a fourth fraction of 40; a fifth of 43; a sixth of 45; a seventh, of 48; an eighth, of 51; a ninth, of 54; a tenth, of 57; an eleventh, of 61, etc. As important as the frequency of these currents, is the intensity

at which each is released for combination with the fundamental, which also has a definite intensity.

In the case of high-frequency fundamentals, in which the combination with partials of still higher frequencies, as harmonics, multiples, etc., is inconvenient, sub-harmonics and exact divisional frequencies are added. For example, if the fundamental has a frequency of 4,096 cycles, its partials such as the first harmonic, the fractions of the first harmonic, and possibly a second multiple, are within the limits of audibility, but higher frequencies are worthless.

In this case, the first sub-harmonic, a frequency 2,048, the second sub-harmonic, a frequency 1,024, and exact divisions of the fundamental, etc., are available for combining with the fundamental at predetermined intensities to produce complex pulsating electric currents which, when converted into sound energy, have predetermined pitch, quality, and volume.

Contradictory to what is generally accepted as correct, and resulting from years of experimenting, it is the tenet of Mr. Eremeeff that the fundamental tone is not that which has the lowest frequency, but the tone which has a predetermined intensity in precisely measured units of loudness, the partials having fractional intensities comparative to that of the fundamental, for the purpose of maintaining the pitch of the combined tone while the quality may be altered as desired during the uninterrupted operation of the entire instrument, by the addition and deduction of other frequencies.

Experiments have proven that if a certain fundamental is mixed with a number of partials, and if in some way, one of the partials is released at an intensity which is greater than that of the fundamental, the combined tone will take the pitch of the loud partial, and the fundamental will become a partial when thus subdued.

This instrument permits of combining with each individual key tone (which represents a predetermined fundamental, sixteen, and more, by other means), partials which are harmonics, sub-harmonics, fractions of the first harmonic, and multiples, and divisions of the fundamental.

THE WESTON 663 VOLT-OHMMETER

(Continued from page 273)

Five tip jacks below the ohmmeter jacks are used for the seven ohmmeter ranges. The particular range required is selected by means of the switch, the designations of which indicate the multiplying factor which should be used on the ohmmeter scale to secure the proper range.

Five tip jacks below the ohmmeter jacks are supplied for the four milliamperage ranges. These ranges, 0.1-5-25-100 ma. are all given with a drop of 500 millivolts. These current ranges are added to this instrument in order to make this device as universal in its application as possible.

The ohmmeter ranges are so arranged that very good readings are available over the entire range from .1 to 10,000,000 ohms. The voltage ranges provide very good reading over the range .05 to 1,000 volts. This range is very complete for general testing work and the sensitivity of 1,000-ohm-per-volt is generally acceptable. The milliamperage ranges provide readings from .02-100 milliamperes. Current readings are not generally provided on volt-ohmmeters, but are supplied on this device.

The market for the Model 663 Volt-ohmmeter is rather wide. It will adequately fill the requirements of the radio Service Man who is interested in point to point resistance checking; the ranges provided being very well suited for this work. Outside of radio there is a field for this device in general service and testing work. Maintenance Departments will find the high and the low resistance ranges of great help in their routine checking of equipment. This is especially true where insulation resistance must be maintained. Laboratories doing research and development work will all find the Model 663 particularly useful, due to the complete current, and voltage measurements.

For convenience, the following data are

given: Resistance ranges of 0-200, 0-1,000, 0-10,000, 0-100,000, 0-1,000,000, and 0-10,000,000 ohms, full scale; voltage ranges of 0-2.5, 0-10, 0-100, 0-250, 0-500, 0-1,000 volts with a sensitivity of 1,000-ohms-per-volt; milliammeter ranges of 0-1, 0-5, 0-25, and 0-100, requiring 500 millivolts for a full-scale deflection.

As stated previously, only one position is available for either voltage or current readings, marked "volts-milliamperes" on the panel. Any range of either type of measurement may be used by merely plugging into the proper pin jacks. For resistance continuity measurements, the test leads are inserted into the pin jacks so marked, and the range switch rotated until the proper multiplying factor has been reached. This multiplying factor indicates the number by which the scale marking of 1,000 must be multiplied to obtain the correct value of resistance.

This instrument weighs but six pounds and is fully equipped with test leads, batteries, etc.

CLASS "A" OR "B"

MANY Service Men, looking at a diagram of a receiver using two tubes in the output stage, cannot tell from the diagram whether the stage is of the class "A" or class "B" type.

One means of determining this is to note whether or not a bypass condenser is included across the bias resistor. If there is no condenser, then the stage is of the class "A" type; if there is a condenser, then you may safely assume that it is a class "B" stage you are dealing with. Another way is to measure the plate current; a class "B" amplifier has a much smaller plate current than a class "A" stage. Be sure that no signal is being received at the time of measurement.

A New Tube-Seller



—with proven profit-making features

The new Weston Model 677 Tube-Seller makes the exclusive features of the Weston-Jewell design available at a cost so low that no dealer or serviceman can afford to be inadequately equipped.

Such proven features as the direct reading three-color tube performance meter, zero-reset test circuit, line voltage indicator and compensating control are combined in the new Model 677.

Ask your jobber to show you one of these new Weston Tube-Sellers!

Pattern 675 Tube-Checker



A compact, light weight tube-checker that is popular for both portable and counter use. Test limits are etched on the instrument panel for quick reference. All present tubes are tested without the use of

adapters. Models are available for both 25 and 60 cycle power supplies.

Ask your jobber to show you the new Weston Model 663 Volt-ohmmeter, designed especially for use in point-to-point set testing.

WESTON JEWELL

Weston Electrical Instrument Corp.,
Jewell Electrical Instrument Co.,
599 Frelinghuysen Ave., Newark, N. J.

Please send me information concerning the complete Weston-Jewell line of radio service requirements.

Name

Address

City..... State.....

KEEP UP WITH RADIO

An opportunity for RADIO MEN to enlarge their scope of training



NEW GENERAL COURSE IN RADIO combines Broadcasting . . . Sound Motion Pictures . . . Aircraft Radio . . . Marine Radio . . . Radio Servicing . . . Home and Studio Recording . . . Television Fundamentals . . . Electronic Tube Applications . . . Radio Code . . . Public Address Systems . . . and other radio and allied subjects.

In a 52-Week General Course at The New York School

At a moderate cost which may be paid \$10 weekly until tuition fee is completed. A graduate of this course is well fitted to handle practical radio engineering problems.

No matter how much or how little knowledge of radio you have, there is a distinct advantage in taking this course. Further details will prove it.

If you wish to specialize in a particular phase of radio or associated arts, send for a copy of our illustrated catalog which contains all particulars about RCA Institutes' various Resident School Courses.

Visit our RCA Institutes School in New York or Chicago. You will find them modern, fully-equipped, and ample in scope for the ever-growing field of radio. We shall be glad to see you at any time of day—morning, afternoon or evening—from Mondays to Fridays inclusive.

Whether you plan a visit to us, wish to enroll for a resident school class, or merely wish a free copy of the new RCA Institutes catalog, fill in and mail the coupon below.

RCA INSTITUTES, Inc. Dept. RT-112
New York School and Headquarters,
75 Varick Street, New York, N. Y.
Chicago School:
1154 Merchandise Mart, Chicago, Ill.

Please send with no obligation to me:

() Full information on the New General Course in Radio. (At New York resident school only)

() Illustrated catalog and information about specialized resident school courses in radio and allied arts.

() Information about extension courses for study at home, together with illustrated catalog.

Name..... Age.....

Address.....

City..... State.....

The Voltage "POLICEMAN" in Your RADIO

BETTER reception for radio owners. Good profit for service men. Send \$1.40 to Dept. RC-11 for sample and sales helps.

AMPERITE Corporation
501 BROADWAY, NEW YORK

AMPERITE
Self-Adjusting
LINE VOLTAGE CONTROL

CHURCH INSTALLATION

(Continued from page 271)

A further and most difficult task for the engineers was the placing of the microphone where it would be least conspicuous. It was necessary, therefore, to employ a highly sensitive microphone, in order to render the speech effective even at a greater distance.

For the diaphragm of the microphone, an aluminum ribbon of only .002-millimeters thickness is used, which is hung up in a magnetic field of about 10,000 Gausses. Through the act of talking into the microphone, the aluminum ribbon is set in motion, generating the low-frequency alternating currents, which, amplified accordingly, are made audible in the loudspeakers. The microphones are fixed about 7 meters (24 feet) above the ground, in front of the main altar. By means of a singularly constructed special microphone cable for this purpose, which in addition to the shielded microphone wirings also contains a steel cable for support, the voice frequencies produced in the microphone are directed into the amplifying apparatus.

The length of the entire microphone wiring amounts to around 87 meters (290 feet), 22 meters (73 feet) of which are suspended in the air. Grounding of the equipment was accomplished by means of a special copper wire connected to earth in the catacombs underneath the cathedral.

The set-up of the amplifier equipment is in keeping with the most modern experience. Operation takes place completely from the alternating-current power unit and is supervised through optical signals from a switchboard. Inasmuch as the microphone as well as the loudspeakers are located in one and the same room, there was some danger that the operation of this system might be considerably impaired by acoustic howls. By careful placement of the speakers with respect to the microphone, it was possible to avoid such disturbances. Through a built-in tone control of a special type, a particularly high degree of naturalness is obtained.

Once more science has proven that even the most difficult problems of acoustics in large auditoriums are capable of a happy solution in these days.

ALL-WAVE SUPER

(Continued from page 289)

used in receivers where only the oscillator circuit is tuned, but with a tremendous loss in sensitivity and selectivity.

Selectivity and Sensitivity

An examination of the selectivity curve, which is shown in Fig. 2, taken in the center of the broadcast band (1,000 kc.), shows that at 100 times normal field strength 9 kc. selectivity is secured; at 200 times normal field strength 10 kc. selectivity is obtained; and, 20 kc. separation is secured at a field strength of 5,000 times normal. What the above means is that the receiver will bring in a distant station through a local having 5,000 times the field strength and separated from the local by only 20 kc. without any interference.

The sensitivity curve of this receiver is shown in Fig. 3, an examination of which reveals that it varies from approximately .016 to .19 microvolts absolute. At 100 kc., the sensitivity is approximately .016, and at 600 kc., the sensitivity is approximately .19 microvolts absolute. Such extreme sensitivity makes possible the reception of distant stations with ease on both the long and short wave bands.

A fidelity curve of the entire receiver is shown in Fig. 4. This curve shows that the electrical fidelity is flat, within plus or minus 2 db. from 30 to 3,500 cycles at 1,000 and 1,400 kc. Sound pressure curves show that the overall response from the speaker is uniform up to approximately 5,000 cycles. At 600 kc., the fidelity falls off slightly, but not enough to impair the quality of the receiver to any noticeable degree.

A front view of the set is shown in Fig. C and in Fig. D an excellent photograph of the power amplifier.

For those desiring a cabinet of modernistic design, the Napier, illustrated in Fig. E, will meet all requirements.

NA-ALD NEW!

Send stamps for charts showing adapters to use with different makes of testing equipment for testing all the new tubes, including 55-85-89-57-58-82-83-G-2-41-42 Wunderlich 5 and 6 prong and the new seven prong tubes.

New Six Prong Latch Lock Analyzer Plug



906WLC	Six prong	\$3.50
	With seven wire cable, two control grid inserts, latch connected to same.	
964DS	6-1 adapter with locking stud	5.50
965DS	6-5 adapter with locking stud	1.25
967SS	6-7 adapter, control grid prong connected to center stud	1.25
967SLC	Same with control grid brought to clip with lead in engage control grid insert	1.25
976CG	Adapter to hold seven prong tube in tube checker or analyzer socket	1.50
		1.25



Button Type Sockets, below panel mounting. Requires only hand drill, to drill mounting holes.

122 UX Red Ring, 423 1Y green Ring, 426 6 prong Blue Ring, 427 7 prong Orange Ring, all 25c each.



Panel mount with ears—Panel hole 1-3/16". Mounting holes 1-11/32" center.

421 UX, 425 1Y, 436 6 prong, 437 7 prong, all 25c each.

Universal Socket 4-5-6, contacting UX-UY and six prong tubes.

Regular Na-ald Mounting To replace sockets with 1-11/16" mounting holes and 1-9/8" panel holes \$1.00 1.25



This Universal Adapter permits testing all new type tubes with your present type tube tester.

Price\$6.00

DISCOUNT GIVEN SERVICEMEN AND DEALERS



Shortwave Coil Forms:
UX-UY and 6 prong ... 25c each

Set of four wound—range 25 to 200 meters with a .00014 infd. condenser\$2.00 a set



Code Set—Code embossed in molded base—buzzer high pitch. 75c postpaid.

ALDEN PRODUCTS CO. AND ALDEN MANUFACTURING CO.
Dept. R
715 Center Street Brockton, Mass.

VELOCITY MICROPHONE

(Continued from page 272)

more complex than the direct sound pressure simulated by the actuator rod. Moreover, since the diaphragm was more or less recessed, cavity resonance occurred. In addition, the dimensions were such as to cause mechanical resonance of the diaphragm at audible frequencies and pressure doubling which accentuated the higher frequency. Obviously most microphone ills could be laid directly to the use of a diaphragm. With this in mind, engineers set out to develop a microphone which would be free of these shortcomings.

The Velocity Microphone

The Velocity Microphone has been dubbed "the microphone without a diaphragm." The description is appropriate for it emphasizes the radical difference in the construction of this new microphone. A less obvious, but also important difference, is that the sound waves, instead of being forced to pass around this microphone, actually pass freely through it. But more important than either of these constructional differences is the fact that it introduces an entirely new principle of microphone operation.

All previous types of microphones were actuated by a change of pressure on the diaphragm. They were, therefore, spoken of as being pressure-actuated. The Velocity Microphone is not. It is actuated by the velocity of the air particles. Thus, it is velocity-actuated—and from this derives its name.

The moving element in this new microphone is a thin metallic ribbon suspended between the poles of a magnet with its length perpendicular to, and its width in the plane of the magnetic lines of force. Permanent magnets are utilized and hence no field supply is necessary. The pole pieces of these magnets are so constructed and cut away as to allow free passage of the sound waves through the microphone. The ribbon element is made of thin duralumin and is so light that its motion corresponds to the motion of the air particles. It is suspended from metal cross-pieces which, in turn, rest on four insulating bushings. These bushings are the only non-metallic parts of the microphone. This construction insures that temperature and humidity changes will have no effect on the operation of the microphone. Moreover, it is sufficiently rugged so that it may be knocked over or dropped without impairing its operation.

Operation

The principle upon which the operation of the Velocity Microphone depends is relatively simple. The ribbon element is caused to vibrate by the air particles of a sound wave. Since this vibration occurs in a strong magnetic field, there is induced in the ribbon a signal voltage corresponding to the undulations of the impressed sound waves. This signal voltage is given by the expressions: $E = blx$; where b = flux density, l = length of ribbon, x = velocity of ribbon.

In this expression, B and l are, of course, constants. The velocity can be shown to be independent of frequency, as follows: The velocity in a mechanical system is the ratio of its pressure-gradient to the acoustic impedance. Both of the latter are proportional to frequency; hence their ratio, the velocity x , is independent of frequency. This being so, the signal voltage E will be independent of frequency and the response of the microphone uniform at all frequencies in the working range. The free-wave curve of the Velocity Microphone (Fig. 1) shows this to be approximately true.

Fidelity

The frequency range of the Velocity Microphone as measured by the Rayleigh Disc method is shown in Fig. 1. Examination of this curve shows that it is nearly flat from the lowest audible tones to beyond 14,000 cycles. The slight falling off at higher frequencies represents a difference which would not be detected by the ear. Moreover, since it is a smooth curve it may, if desired, be compensated for in the following amplifier.

For comparison, curves made on other types of microphones under identical conditions are also shown in Fig. 1. The peaks and dips, which engineers found caused the whistles and lisps, marring many broadcasts, are plainly evident. These peaks are traceable to diaphragm

resonance, cavity resonance and pressure-doubling. All three result because of the use in all previous types of microphones of a pressure-actuated diaphragm.

Because the Velocity Microphone is a velocity-actuated device—does not utilize a diaphragm, it is subject to none of these undesirable phenomena. As a result its frequency response is a flat curve—and its reproduction is more natural than that of any microphone yet devised.

Directional Characteristic

The intensive study of studio technique, which many stations are making, has made the directional characteristic of the microphone used, of considerable importance. This results from the fact that this characteristic has two important effects. It determines, first, the placing of the artists, and second, the amount of reverberation picked up by the microphone. All previous types of microphones were very unsatisfactory in this respect. The condenser microphones, as well as more recently developed microphones in which the diaphragm supports an additional moving element, are entirely non-directional up to 2,000 cycles, while at higher frequencies they become very directional.

This is due to the fact that these microphones are pressure-operated—it is a phenomenon typical of all microphones using a diaphragm. Such a characteristic is, in fact, more undesirable than a pure non-directional characteristic throughout the entire range. In general, excess reverberation occurs at the lower frequencies due to the fact that the absorption characteristics of most material used in reducing reverberation are less efficient at the lower frequencies. Using a microphone which is non-directional at the low frequencies and directional at the higher frequencies means that the excess low-frequency reverberation will be further accentuated.

This means that the amount of direct sound pick-up must be relatively great in order to keep it well above the level of the reverberated pick-up. This entails crowding of the artists about the microphone and—because of the non-directional characteristics of such microphones at the higher frequencies—requires direction of the microphones on the point of action.

The Velocity Microphone is particularly good in this respect. It has a marked directional characteristic which is entirely independent of frequency. Due to this characteristic, the energy response of the Velocity Microphones to generally reflected sound is only one-third that of non-directional microphones such as the condenser and other pressure-operated types. This has a very important effect on the distance at which artists may be placed from the microphone. The maximum satisfactory distance is determined by the allowable reverberation.

Reverberation is the ratio of the generally reflected to the direct sound. The generally reflected sound is usually independent of the positions of source and microphone. As noted above, the Velocity Microphone reduces this by a factor of three. The direct sound varies inversely as the square of the distance, hence with this microphone the artists may be placed 1.7 times further away than they were with pressure operated types of microphones.

This advantage may be utilized in other ways. For instance, if the spacing of microphones and artists is kept the same, much less damping or absorbing materials need be used on the walls and ceiling in order to obtain, with this new microphone, the results previously obtained with other types. Moreover, the amount of reverberation can be adjusted as desired by turning the microphone at a slight angle to the source. This can be done with the Velocity Microphone where it could not with previous types, because it does not, like these latter, discriminate against the high frequencies when so used.

Another feature not before mentioned is the bi-directionalism of the Velocity Microphone. The construction, which is open both in front and back, allows pick-up equally in both directions. As a result artists may be placed equally both in front and in back of this microphone. Thus it may be used to pick up programs in which twice as many artists participate. (Continued on page 311)

The first Resistor Guide ever published



FREE

with an order for 20 Metallized Resistors—or for kit No. 1 or No. 2

and still the LEADER

The I.R.C. Resistor Replacement Guide—bigger and more comprehensive now than ever! Last fall, 32 pages—this fall 88. Increases every month by four additional pages at no added cost to owner.

Over 15,000 Servicemen use the I.R.C. Guide. Why? Because it gives them instantly, quantities of information they need in their daily work. Complete resistor data about any popular receiver—the value and code and position in the circuit of each defective unit. Price just the same as last year—\$1. Or you get the Guide FREE by purchasing 20 Metallized Resistors—or I.R.C. Kit No. 1 or No. 2.



I.R.C. Handy Kit No. 1 contains 20 1-Watt Metallized units ranging from 500 ohms to 3 megohms.

I.R.C. Handy Kit No. 2 contains 20 2-Watt units, ranging from 500 ohms to 1/2 megohm.



The I.R.C. Grid Bias Kit contains 10 assorted Metallized units and Power Wire Wound (5 Watt) types, required to bias the following tubes—'24—'26—'27—'71A—'10—'45—'50—'47.

Ask your jobber or write us at once for these time-saving kits or Resistor Guide. Get on the I.R.C. mailing list to receive other service helps.

INTERNATIONAL RESISTANCE CO.

Philadelphia, Pa.

Toronto, Ont.

IRC

Metallized

AND POWER WIRE WOUND—
PRECISION WIRE WOUND
R E S I S T O R S



Insure YOUR WORK
with
CLAROSTAT Replacement VOLUME CONTROLS

CLAROSTAT Replacement Volume Controls are "Custom-Made" to exactly suit the receivers for which they are offered. Not a makeshift job lot idea.

The resistance, taper, shape and shaft are made according to the proper specifications.

There is no delay in installing them. There are no comebacks when you use CLAROSTAT products.

See the new CLAROSTAT CONTROL HANDBOOK AND CATALOG for 32 pages of dope for service men. Send for your FREE copy.

CLAROSTAT Mfg. Co.
285-287 N. 6TH ST. BKLYN. N.Y.



More Capacity at Less Cost

Latest research by oldest condenser manufacturer is reflected in present extensive and varied line of

DUBILIER ELECTROLYTICS

Available in all types—round and square metal cans, cardboard containers, tubular paper wrappings, high-voltage, low-voltage, tapped units, etc. Positively guaranteed

For quickest reforming time, lowest leakage, highest working voltage, longest life. And they cost less!

WRITE for literature on Dubilier Electrolytics as well as all other types of condensers.

Dubilier Condenser Corporation
4377 Bronx Blvd. New York City

Study RADIO in CANADA

A start in Radio Guaranteed or your money back. Course covers Radio, Television, Sound Amplification and Telephony. Practical work material supplied. Preparation for Government and Service examinations. Home Study, Day or Evening Classes. Write for booklet.

RADIO COLLEGE of CANADA Limited
310 Yonge Street Toronto, Canada

HILET ENGINEERING CO.
WEST ORANGE, N. J.

Designing and Manufacturing Specialist in Pie Wound Modulation Reactors, Filter Chokes, Rectifiers, Plate and Filament Transformers.

Write for quotations on made-to-order material designed to suit your Station Circuit, or new installation.

A UNIVERSAL P. A. AMPLIFIER

(Continued from page 276)

tubes directly from the storage battery which is the connection for automobile or sound truck battery operation when using the Auto A.C. Power unit. When open and SW3 is thrown to the right, the filaments of the tubes light from a separate secondary winding on the power transformer which is the position for operation from 110-volt A.C. power supply. SW4 is merely an S.P.D.T. switch which facilitates the immediate selection of operation from the detector stage of any radio set or tuner or from a microphone, a phonograph pick-up, or from a control board.

The volume control consists of a dual potentiometer, D1, connected in the input circuit of the push-pull '37 tubes. The center tap of these two potentiometers, in reality, connects to the center tap of CH1, thus satisfying prerequisites for push-pull operation.

The 250,000 ohm resistor, R3, is merely a bleeder resistor for the power unit and prevents rupturing the filter condensers if the tubes should be removed from their sockets while the power is on.

The heaters of the six tubes used in the amplifier proper are connected in parallel. One leg of these filament terminals is labeled "A" and the other "B." The values of all parts are shown on the diagram. The tone control consists of a number of condensers connected in multiple by means of a switch. As more bass is desired, more and more of the condensers are cut in the circuit across the secondary of the push-pull input transformer, A.F.T.1.

Six-volt D.C. field horn or cone type dynamic speakers are recommended. Said speakers obtain their D.C. field excitation from a car storage battery. Where any other type D.C. speaker is employed, the necessary field excitation would have to be supplied indirectly by the A.C. power unit. This would cause a larger drain from the storage battery too; no advantage would be gained therefrom.

When operated directly from a 110-volt A.C. main, the speaker field must receive its excitation from a separate dry rectifier and condenser unit, as shown in Fig. 2B. The output of this unit supplies 6-volts, D.C. for the field. When in mobile service (or operated from a storage battery) the 6 volts for the field is secured directly from the storage battery which operates the Auto A.C. power unit. Of course, dynamic speakers which have a permanent magnet may be used, and they do not require a field supply. This would obviate the necessity for the separate rectifier circuit.

The Auto A.C. Power Unit

Figure 2B is a schematic circuit of the A.C. power unit. It consists of a rotating armature having a commutator mounted on its shaft with a single brush making contact. In other words, the rotating device is merely a chopper which breaks up the D.C. from the storage battery and feeds it to the primary of a transformer, the output of which delivers 110 to 115 volts A.C. It is because the output of this device is 110 volts that the amplifier may be plugged either into the "B" unit or into a wall socket, at will. In this manner, the universal feature is achieved. It might be well to mention that the efficiency of the entire system is relatively high and is but 6½ by 7¼ by ins., in size.

This unit may easily be constructed at home if the wiring diagram is followed and the photograph referred to. It might be well to mention, at this time, that all condensers, resistors, etc., are mounted under the baseboard. The only parts mounted above are marked on the photograph.

In view of the fact that the Auto A.C. power unit is rated at but 65 watts and is designed to merely supply plate and screen requirements, plus the filament power of the 82, a total of approximately 13 amperes is consumed from the storage battery (the additional three amperes being consumed by the tube filaments). As an added precaution, therefore, it would be well to use several storage batteries in parallel so that each one supplies but a fraction of the 13 amperes.

Special Beginner's Number

GREATEST MAGAZINE

ON Short Waves

NOW 25c A COPY

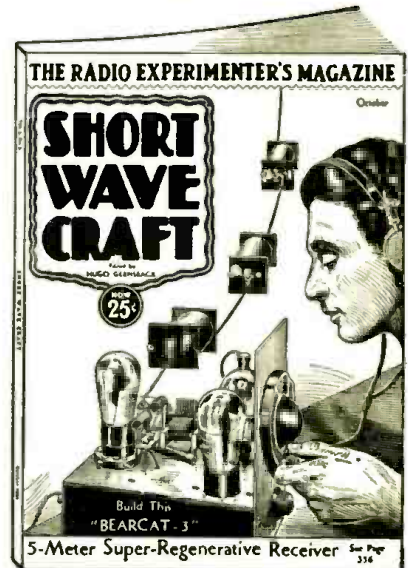

At All Large Newsstands

4-Color Cover 9"x12" in Size Over 200 Illustrations

RAPIDLY increasing each day are the number of experiments in the Short Wave field—developments which are bringing to this branch of radio thousands of new "thrill seekers." Experimenters, as in the early days of Radio, again have the opportunity to bring about stirring new inventions. Read in **SHORT WAVE CRAFT**, the *Experimenter's Magazine*, how you can build your own Short Wave Sets, both transmitters and receivers. **SHORT WAVE CRAFT** is exclusively a short wave magazine—the kind you have wished for so long.

Interesting Articles in the Current Issue

- One-Tube Super-Regenerator, by R. W. Tanner.
- Hear 'Em Roll In On this 1-Tube, by Clifford E. Denton.
- A 3-Tube "Signal Gripper," by Walter C. Doerle.
- Smoothing Up Regeneration Control.
- Doublet Antennas Eliminate Interference, by Everett L. Dillard.
- Prize-Winning 1 and 2-Tube Receiving Sets.
- W9ZG Saves A Life! (Short Wave "Fiction"), by A. D. Middleton, W8UC.
- Power Amplifier for S-W Receivers, by Louis Martin.
- Long Wave Receiver—How to Build—Range 150 to 3000 Meters.

SPECIAL OFFER COUPON

SHORT WAVE CRAFT RC-11
98 Park Place, New York, N. Y.

GET ACQUAINTED OFFER

- As per your Special Offer, I enclose \$1.00 (Canada and foreign \$1.20) for which enter my subscription to **SHORT WAVE CRAFT** for 8 months. (I understand that your regular rate for a year's subscription is \$2.50).
- Mail me a sample copy of **SHORT WAVE CRAFT** for which I enclose 15c (U. S. Stamps or coin accepted).

Name

Address

City..... State.....

A UNI-DIRECTIONAL LOOP ADAPTER

(Continued from page 275)

Switching is accomplished in the input unit by means of the rectifiers V1 and V2. The plates of these are supplied by alternating voltage from the transformer and consequently act as a full-wave rectifier. Since the power supply is 60 cycles, V1 acts during 1/120 second and then V2 during the other 1/120 second. While V1 is acting, the left part of the loop is functioning. During the same time, tube V4 also rectifying the output in a similar manner, is supplying the output of the set into the milliammeter in the direction shown by the arrow. During the next half cycle, input rectifier tube V2 acts and also V3. But an examination of Fig. 4 will show that during this latter half of the cycle, the signal strength is less, hence, the average, steady reading of the D.C. meter will be that governed by the direction shown by the arrow.

Elimination of the 180-Degree Error

This device, in combination with the tapped loop-aerial and the synchronous switch arrangement, also eliminates the so-called 180-degree error. In most direction finders, it is necessary to provide a special "sense" aerial to permit the operator to determine whether the station being received is before or behind him. Reference to Fig. 4 will indicate how this is accomplished in our unit.

Suppose the radio signal is coming from D1 instead of C1. In this case, the field pattern X gives the greater induced voltage and tends to deflect the meter in a corresponding direction, opposite to the direction if the signal was from the direction C1. To determine if the incoming signal is from C1 or D1 it is necessary only to rotate the loop according to a definite standard rotation, say clockwise. For direction C, the pointer of the milliammeter will swing, say, from left to zero center, then right as the loop-aerial is rotated past the general direction of the transmitter from left to right; while for direction D, the pointer will swing from right through zero center to left. If clockwise rotation of the loop is adopted as standard, it is preferable to use the orientation of the loop such that when the radio signals come from the direction C, a deviation of the loop on either side will produce a corresponding deviation of the meter to the same side. For example a motion of the loop to the left of the "dead-center" will produce a meter reading to the left.

It may be seen that this direction finder does not depend on any exact balancing of the amount of current due to the vertical effect with that due to the normal loop-aerial field-intensity pattern. As long as sufficient vertical effect is present to distort the normal figure-of-eight pattern, the unit operates satisfactorily. A further advantage of this type of direction finder is that it does not work on the minimum intensity. This makes the loop a much more efficient collecting device and permits the adaptation of the unit to the reception of broadcast signals in an efficient manner.

Description of the Equipment

Referring to the schematic circuit of the loop unit (Fig. 5), A is the input circuit and comprises the tapped loop and vacuum tube switching arrangement; B is the radio receiver used for amplifying and detecting the signal received on the loop aerial; C is the output unit which is synchronized with the input unit A; D is the synchronizing unit and supplies synchronizing voltages to the input and output units to secure the proper reversal of the field intensity pattern by switching first one side of the loop-aerial into the circuit and then the other.

In the input unit A, the loop-aerial is connected at each terminal through blocking condensers C2 and C3 to the rectifier tubes V1 and V2; the cathode circuits of which are connected together and grounded. The switching of the two parts of the loop-aerial to the receiver is accomplished by the application of a low-frequency alternating current (the frequency of the power supply) to the plates of the rectifier tubes V1 and V2.

It is well known that a vacuum tube has the ability to pass current in one direction only; and as the alternating current passes through its cycle, the current flows first in one direc-

tion through V1 and then in the other through V2. This provides a low resistance path for first one side and then the other of the loop to the receiver. Two R.F. chokes R.F.C.1 and R.F.C.2 prevent the loss of R.F. current through the switching circuit.

The tuning condenser C1 is not strictly necessary for the operation of the device, as the loop is not tuned to resonance with the incoming signal. However, as the pickup would not be equal over the broadcast band without some shifting of the resonant frequency of the loop, the condenser is merely tuned roughly to increase the signal strength on the two ends of the band. The loop is not tuned to resonance, as this would prevent the correct operation of the direction indicating instrument.

The radio receiver, B, requires no explanation, being any of the usual types comprising an R.F. amplifier, a detector and an audio amplifier. Of course it must be capable of picking up signals with a loop-aerial.

The circuit arrangement of the output unit is shown at C of the schematic diagram. C4 and C5 are two equal condensers, one terminal of each being connected to the output of the radio receiver, and the other terminal of each being connected to the plate circuits of the two tubes V3 and V4 which switch the current from one circuit to the other alternately as the alternating current reverses. As the same current is used in these rectifier circuits as in the others (V1 and V2), these circuits are obviously changed back and forth at the same time or in synchronism. The cathode terminals of these two tubes are connected to the ends of a potentiometer P, and then to the terminals of the zero-center milliammeter. The center tap of the potentiometer is connected to ground and each side of the resistor is shunted by a condenser C6 and C7. The audio frequency choke coils C11.3 and C11.4 prevent the A.F. signals from being grounded.

The synchronizing unit consists of a transformer with a center-tapped secondary for correct phasing of the current. This transformer may be supplied with any source of low, audio frequency such as the light-current supply or an A.F. oscillator. In the case of our unit, for operation with a broadcast set, the light-line supply is the most convenient. However, as the 60-cycle supply may be picked up when a carrier wave is received, a filter in the lead from the loop-aerial to the receiver may be necessary. This consists of an A.F. choke and a small, fixed condenser connected as shown in Fig. 6. The choke holds back the low frequency current and the small condenser carries the radio frequency current. The capacity of this condenser is too small to pass the audio currents.

The shields for the unit consist of a sub-panel made of aluminum with corner posts for supporting the sides and separators which divide it into three compartments. The base is drilled to support all the parts except the meter and the variable condenser. The photographs clearly indicate the positions of the parts. The front panel is equipped with two slotted posts to support the partitions. It is drilled to mount the meter which is of the flat panel mounting type. For this purpose, a hole of 2 3/4 inches in diameter is required. The most practical way to drill this hole is to mark the circumference with a compass and then drill a number of small holes close together around this line. The piece in the center can then be cut out with a hammer and chisel.

The variable condenser must be insulated from the metal panel, and for this purpose, a strip of bakelite 1 x 4 x 3/16 inches is drilled to fit the mounting holes of the condenser; the mounting screws are countersunk so that they do not touch the panel. Then the bakelite strip is mounted with two screws to the panel. The hole for the condenser shaft must be made sufficiently large so that it does not touch as this would short one side of the condenser to ground.

As the photographs show, the parts are all mounted above the sub-panel, except the condensers. The wiring is carried below the sub-panel for neatness and the parts are arranged so that the wiring is as short as possible. The wires from the power transformer pass through

Cash in with Newest Most Reliable Method of Set Analysis



Readrite

No. 1000 Tester

Tests—Volts, Milliamperes, Point-to-point Resistances, Continuities, Short Circuits, Capacities.

\$33 Net to Dealer

TWO cable plugs connect set sockets through selector switch to the precision volt-milliamper-ohmmeter . . . an exclusive Readrite feature. Speeds up tests without removing chassis. Measures resistances up to three megohms—D.C. Volts up to 600 and milliamperes up to 300. Also A.C. line volts and capacity of dry and electrolytic condensers.

A fine instrument in leatherette case. Complete with batteries, test cords and full instructions.

READRITE METER WORKS
17 College Ave. Bluffton, Ohio

MAIL TODAY!

READRITE METER WORKS,
17 College Ave., Bluffton, Ohio.

Gentlemen:

Please send me information about Readrite No. 1000 Resistance Continuity and Capacity Tester. Also Catalog of other servicing instruments.

Name _____

Street Address _____

City _____

State _____

Train Now for New RADIO Opportunities

Get Into a Line Where There's Action—
Every Day—And a Pay-day Each Week — You Be the Boss!

Right now while hundreds are looking for work where there isn't any, the radio service field can use trained men. With the proper training and the necessary equipment you can enter this field and make a comfortable living. We include with our course this modern set analyzer and trouble shooter without any extra charge. This piece of equipment has proved to be a valuable help to our members. After a brief period of training, you can take the set analyzer out on service calls and really compete with "old timers." We show you how to wire rooms for radio—install auto sets—build and install short-wave receivers—analyze and repair all types of radio sets—and many other profitable jobs can be yours. Teaching you this interesting work is our business and we have provided ourselves with every facility to help you learn quickly yet thoroughly. If you possess average intelligence and the desire to make real progress on your own merits, you will be interested.

YOURS without extra cost. This excellent set analyzer and trouble shooter included with our course of training.

ACT NOW—MAIL COUPON

Start this very minute! Send for full details of our plan and free booklet that explains how easily you can now cash in on radio quickly. Don't put it off! Write today! Send now!

RADIO TRAINING ASSN. of AMERICA
Dept. RCA-11, 4513 Ravenswood Ave., Chicago, Ill.
Gentlemen: Send me details of your Enrollment Plan and information on how to learn to make real money in radio quick.

Name

Address

City..... State.....

LYNCH

Noise-Reducing Antenna Products Solve the Interference Problem!



Practically noise-free results on all waves, long and short alike. For the broadcast listener, the short wave and television experimenter and the "amateur." No serviceman should be without these LYNCH Antenna Products which have proved their ability, by test, to eliminate background racket. Ideal for suburbs as well as the most congested city areas. Very simple to "hook-up" to any receiver, better performance assured.

- (A) **LYNCH Transposition Blocks**
Extremely durable. Made of "Lynchite," a new material, recognized for its great resistance and natural freedom from electrical losses.
Handy Complete Kit of 10 Blocks.....\$2.50
- (B) **LYNCH Case-Aerial Spreaders**
For making non-directional and high-gain aerials. Also made of "Lynchite."
Handy Complete Kit of 10.....\$2.50
- (C) **LYNCH "U. S. Navy Standard" Antenna Insulators**
Prevent electrical loss or leakage across the antenna insulators. Kit of 8.....\$3.00
- (D) **LYNCH "All-Wave" Antenna Coupler**
Secure best possible results with any of the noise reducing antenna systems recommended by us.....\$1.50

LYNCH RESISTORS

METALLIZED		PRECISION WIRE WOUND	
1/2 Watt 30e List	•	1 Watt Rating	1% Tolerance
1 " 30e "		Values from 1 ohm	
2 " 40e "		to 500,000 ohms	
3 " 50e "		Write for Prices	
POWER WIRE WOUND		AUTO RADIO SUPPRESSORS	
3 Watt 50e List		Spark Plug Type	
5 " 50e "		Distributor Type	
10 " 65e "		Cable Type	
15 " 70e "		All Types.....List \$5.00	

SERVICEMEN—Discount of 40% from above List Prices
Send order TODAY or write for new, illustrated and descriptive folder.
LYNCH MFG. CO., Inc., 1755RC B'way., N.Y.

holes in the sub-panel. The transformer is designed to supply filament current to the four 27 tubes and is equipped with three 2.5 volt windings for this purpose. It also supplies the switching current and for this purpose it has a 200-volt center tapped winding. While it is not necessary to use a very high voltage for the switching circuit, the resistance of the path for the high frequency current is less under these conditions than with a low potential.

The loop is made in the form of an oblong, with the wires spaced on spreaders—this type of loop is often referred to as the box type. It may be purchased, or may be made at home. Fig. 7 shows how a suitable loop may be constructed. No. 18 wire is used, and 16 turns are wound, with a tap at the 8th turn. The wire is spaced 3/8 inches between turns. As the illustration shows, the frame for the aerial is 3 feet high by 2 feet wide and the spacers are 6 1/2 inches wide.

Adjustment and Operation

The adjustment and operation of the unit is very simple for the purpose of radio reception. First, the potentiometer contact arm should be placed about half way around the resistance strip. Then, the output unit should be connected, with a wire to that loudspeaker terminal that is directly connected to the plate of the power tube in the set. If this cannot be located easily, the contact can be made to the plate prong on the power tube. The ground should also be connected. The receiver is then turned on using an outdoor aerial. The volume control of the set should be turned down temporarily and a station tuned in. It will be found that the needle of the meter jumps to one side. The potentiometer must then be readjusted until the needle remains practically stationary.

The meter circuit is now balanced and the loop-aerial can be connected to the input unit with a wire running from the center loop terminal to the aerial binding post on the receiver. If a hum is heard in the loudspeaker when a station is tuned in, the hum filter must be connected in the lead to the aerial post on the set. In extreme cases, it may be necessary to connect a 100,000-ohm variable resistor across the aerial and ground binding posts of the receiver, and adjust it until the hum is reduced sufficiently. However this should be done only in case of necessity, as it will reduce the signal strength somewhat.

Do not let these hints disturb you though, as a well shielded set and loop unit will introduce no noticeable hum.

The next step is to turn the loop in the general direction of the station to be received, following the directions previously given for tuning the loop in a clockwise direction. Tune the receiver to the wavelength of the station and when signals are heard, readjust the loop, watching the meter until the needle registers zero. The loop is then centered on the station and a possible final rough adjustment of the loop condenser for greatest volume is all that is necessary. The latter adjustment is only needed if the station is a long-wave one and the condenser happens to be turned to the minimum capacity. Otherwise, it need not be touched.

Uses

While the original direction finder was designed for airplane direction finding, the adaptation described here is a useful addition to the broadcast set. A direct current model of the unit is invaluable for the location of sources of interference.

List of Parts

- The parts required for the construction of the Air-Loop Unit are listed below:
- One Loop—center tapped—to cover the broadcast band with a .00035-mf. variable condenser;
- One Hammarlund .00035-mf. variable condenser, type ML-17, C1;
- Two Hammarlund 85 mh. R.F. chokes, type RF-C85, R.F. C1, R.F. C2;
- Four 1-inch 5-pfing tube sockets type 15G;
- Four Triad 27 tubes—V1, V2, V3, V4;
- Two Aerovox .25-mf. bypass condensers, type 260, C2, C3;

(Continued on page 311)



MILE'S Amplifier and Power Equipment
Lapel Mikes:
1 Button Type, \$5.00 and \$10.00
2 Button Mike, \$10.00 and \$15.00
Professional Mikes, \$15.00 up
Any Mike rebuilt, repaired, up to \$10.00.
Mike Preamplifier, \$29.50
Power Amplifiers, battery operated; also 110 V., 50-60 Cycles—All types
5 Types Miles Giant Units
10 Types Miles Horns and Trampets
Miles Exciters for Horn Units
Diaphragms & Voice Coils for Horn Units.
Input, Output and Power Transformers.
Write for Catalogue RC
MILES REPRODUCER CO., Inc.
Dept. RC, Miles Repro. Bldg., 244 W. 23rd St., N.Y.C.

FREE Amateur and Servicemen's Wholesale Guide

Hot off the press! Chock full of the latest of everything for the Radio Serviceman, Amateur, Experimenter. Detailed illustrations; vital and interesting facts. Valuable tips that mean money in your pocket.
Astounding Low Wholesale Prices
Hundreds of "Hot Shot" bargains at deep cut prices that challenge all America.
WRITE TODAY—A free copy of this record smashing book is ready for you. Write for it today!
BURSTEIN-APPLEBEE COMPANY
1408D McGee St., Kansas City, Missouri

SERVICEMEN

MAKE MORE MONEY
Don't throw away your old Volume Controls. Have them REBUILT. Save up to 50%. Any graphite resistance.
Save Money on Your Transformers
Standard Volume Controls, only 50c.
Specials and Tandem Controls, only \$1.00.
Have us rewind your old coils. You stack the laminations. Simply send coil with one lamination. Special coil data, or complete transformer. Transformer and speaker field coils rewind—\$1.00 and up.
F. W. PEMBLETON
17 years experience in the design of coils and transformers up to 1 K.V.A.
921 Parkview Ave., Dept. C., Fort Wayne, Indiana

TRICKS WITH ELECTRICITY

Make electric lights obey voice, make things run, jump, kick, spin, vibrate, buzz, sizzle, shock, flash, mystify—all by electricity. Make window novelties, tick lights, floating rings, spirit rapping—all kinds amusing, practical devices at home. Book tells how to do 200 stunts with 100 volts A.C. Postpaid \$1.00.
CUTTING & SONS, 11-L-St., Campbell, Cal.

Knowledge Pays Big

We teach you how to build and operate Radio Treasure Finders and how to locate Metals Underground. Fascinating, Scientific, Accurate. Full details for 3c stamp—Write TODAY.
Exchange, P. O. Box 607-W El Monte, Calif.

Autocrat Auto Radio \$17.45

6 TUBE
175 to 550 Meters
Complete less "B" Batteries But Plus Tax
Complete accessories include mounting brackets, illuminated dial, lock switch, remote control, dynamic speaker, 6 RCA (Disc.) Tubes, spark suppressors, and antenna. Everything except "B" Batteries. Small and compact 5 1/2" x 6 1/2" x 8 1/2". Distance range 100 to 1000 miles. No catalog available. Send \$2.00 deposit. Balance C.O.D.
AUTOCRAT RADIO CO., Dept. R.C.
3855 N. Hamilton Ave. Chicago, Ill.

It's The "New Thing" In Pens

EVERY school boy and girl will find a new thrill and a new inspiration in the Conklin Nozac (no sack)—"The Pen That Winds Like A Watch." You fill and empty this amazing pen by turning the knurled end of the barrel—like one winds a watch.



This new filling device eliminates the conventional rubber sack inside the barrel and gives the Conklin Nozac 35% more ink capacity.

You can see at all times how much ink is in the pen through a transparent section in the barrel.

And it's built like a watch too, of finest materials careful workmanship, absolute precision in every detail. Priced right down within reach of everybody at \$5.00 and more. Pens to match \$3.50 and more. Many beautiful new colors. Ultra-modern shapes. Ask your dealer to show you a Conklin Nozac.

Another outstanding pen is the Conklin Endura at \$5.00 and more—the peer of the best of all pens employing the familiar rubber sack ink reservoir. Other Conklins \$2.75 and more.

THE CONKLIN PEN COMPANY
Toledo Chicago San Francisco



THE SPECIALTY TESTER

(Continued from page 277)

case, as may be seen from the following description: The low-capacity circuit of Fig. 1 has a safety resistance (R9) fixed at 75,000 ohms to limit the voltage to 75, the variable resistance RV-3 controls about 50 volts, thus allowing for variations of high- or low-line voltages. If the entire resistance were variable, it would be possible to impress 100 or more volts on a 1 ma. meter—when all the resistance is cut out—and good-bye meter! The same idea applies to the other capacity ranges.

The shunts are designed for a 5-volt drop, therefore the compensating resistance R12 was placed in series with the rectifier, to facilitate the use of these shunts. On the high-capacity range, it was impossible to purchase a variable resistance of small dimensions that was rated at 500 ma., therefore, resistance R14 was placed in parallel to divide the load. Resistors R7, R8, and R14 should be rated at 20 watts.

To take readings on the capacity meter, two leads must be connected from the tip jacks marked "line" to an A.C. outlet. Do not plug into A.C. line first. Select the required scale reading from the chart shown elsewhere in this article, press down on the momentary switch SW, and vary the adjuster for the range selected until the indicator on the meter reads full-scale the 1000 range. (All capacity readings are calibrated to this scale.) Then pull the plug out of the A.C. socket, use two other test leads from tip jacks marked "CAP," connect these leads to the condenser to be tested, put the plug back into the A.C. socket and read the capacity. If the indicator on the meter does not move, then the condenser is open; if the indicator shows a full-scale deflection, then the condenser is shorted.

The following chart has been prepared for convenient readings on the 1,000 scale:

Low Capacity Range		Med. Capacity Range		High Capacity Range	
Reading on 1000 sc.	Scale	Reading on 1000 sc.	Scale	Reading on 1000 sc.	Scale
.0025	10	.1	10	4	235
.0045	20	.25	50	5	290
.007	45	.5	110	6	345
.012	70	1.0	210	8	410
.02	125	2.0	525	10	540
.03	180	4.0	800	12	650
.05	220			14	700
.07	260				
.1	290				
.15	435				
.2	580				
.3	780				
.5	910				

As an added precaution, when testing condensers a fused A.C. plug, with space for two fuses, is recommended when making up leads for the A.C. line. The fuses used are rated at 1 ampere. When condensers are to be tested in quantity, a switch is recommended in one of the A.C. leads. This will eliminate the necessity of pulling the plug out of the A.C. socket.

The Ohms Locator

The ohms locator is a new and novel feature in testers. The purpose of the ohms locator is to determine the values of resistors suitable in various circuits. The maximum range is 100,000 ohms, and is only recommended for use in circuits where the power requirements do not exceed 5 watts. To find the maximum values of resistance required in a circuit, connect two leads from the tip jacks marked "O.L." to the circuit where the resistance is to be measured, then vary the "O.L. Adj." until best results are obtained. Disconnect the lead from the second tip jack from the left, as shown in the diagram of Fig. 1 and place the tip of the first lead into tip jack No. 3 on the left of the diagram. Set the selector switch to the "I.L.O." position and if the reading is low, set the selector switch on "M.O.", etc. The object is to try to read the value of resistance in the middle of the scale as that is the most convenient part of the meter to read.

(Continued on following pages)

Start Your Career Today

In the world's fastest-growing industry—

You can, if you will, start your career today in the world's healthiest and fastest-growing industry—RADIO. The biggest and most talked of building project in the world—RADIO CITY—is but an advance sign of the future this industry holds for the man who gets started in it today, while the industry is still young. The first move is up to you. Read this advertisement carefully and then send in the attached coupon. But do it now. Get started.



The three volumes of this library cover the entire field of building, repairing and "trouble-shooting" on modern radio receivers. The Library is up-to-the-minute in every respect and is based on the very latest developments in the design and manufacture of equipment. The rapidly-growing interest in short-wave and television reception is thoroughly covered in a complete section which deals with the construction of this type of apparatus.

Radio Construction Library

INCLUDING CONSTRUCTION OF SHORT-WAVE AND TELEVISION RECEIVERS

By JAMES A. MOYER and JOHN F. WOSTREL

Faculty, University Extension, Massachusetts Department of Education

Three Volumes — 1087 Pages, 6x9
605 Illustrations

VOLUME I: presents the fundamental principles of radio so clearly and simply that anyone of average training will be able to read, understand and apply them. It gives actual working drawings and lists of materials for the construction of many typical sets.

VOLUME II: fully discusses all of the elementary principles of radio construction and repair. An explanation of the necessary steps for "trouble-shooting," repairing, servicing and constructing radio sets successfully. Practical data is also given on antenna systems, battery eliminators, loud speakers, chargers, etc. This volume includes complete instructions for the construction and operation of short-wave and television receivers.

VOLUME III: covers the essential principles underlying the operation of vacuum tubes in a non-technical manner as is consistent with accuracy. It discusses the construction, action, reactivation, testing and use of vacuum tubes; and an interesting section is devoted to remote control of industrial processes; and precision measurements.

EXAMINE these books for 10 days FREE

This Library is not only a thorough home-study course, but a handy means of reference for the more experienced radio experimenter, repair man, and radio shop-owner. To these men, as well as to those who desire to advance in the radio profession, this offer of a 10 days' Free Examination is made.

Simply clip, fill in, and mail this coupon

McGRAW-HILL FREE EXAMINATION COUPON

McGRAW-HILL BOOK COMPANY, INC.
330 W. 42nd Street, New York.

Gentlemen—Send me the new RADIO CONSTRUCTION LIBRARY, all charges prepaid, for 10 days' Free Examination. If satisfactory I will send \$1.50 in 10 days, and \$2.00 a month until \$7.50 has been paid. If not wanted I will return the set at your expense.

Name

Home Address

City and State

Position

Name of Company..... 2

(WRITE PLAINLY AND FILL IN ALL LINES)

(Books sent on approval in U. S. and Canada only.)

Are You Ready For an ENGINEERING COURSE IN RADIO??

An advanced course in Radio and Television Engineering is a NECESSITY for the radio man who is ambitious! One thing is certain—when EXPERIENCE has carried you part of the way—higher technical knowledge is necessary for further advancement!

It's An Advanced Course For The Man Who Is Already In Radio!

We're not trying to OVERCROWD the radio profession—it's the object of this course to HELP THOSE WHO ARE ALREADY IN IT!

MAIL TODAY!

Capitol Radio Engineering Institute, Inc.
14th and Park Road, N.W.
Washington, D.C.

Please mail me, without obligation, your new booklet on "Practical Radio Engineering."

Name

Address

City and State.....

RC-11

Your Copy is Ready



Service Men—
Write for your
FREE Copy
of our 1933
Radio Catalog

LOWEST WHOLESALE PRICES

80 Pages of everything you need in Radio. Complete stocks of the highest quality replacement parts, tubes, test equipment, and accessories at the lowest wholesale prices.

UP-TO-THE-MINUTE SERVICE

Our tremendous stocks and efficient organization are waiting to serve you promptly, courteously, and efficiently. Write today for your FREE COPY of our 1933 Service Men's Radio Catalog.

Allied Radio Corporation

835 W. Jackson Blvd. Chicago

BACK ISSUES

of RADIO-CRAFT can be had at the price of 25c each. Address

RADIO-CRAFT
98 Park Place New York, N. Y.

We have all parts in stock for Jack Grand's
SPECIALTY TESTER
described in this issue
At Lowest Wholesale Prices

SUN RADIO CO.
64 VESEY ST., N. Y.

List of Parts

Although other parts made by good manufacturers may be substituted, the following parts were used in the construction of the Specialty Tester and have been found satisfactory:

- One Weston, Model 301, 1. ma. Meter, M;
- One Taurex rectifier, RX;
- One Lynch, 4,000-ohm resistor, R1;
- One Van, 10 ma. shunt (D.C.), R2;
- One Van, 100 ma. shunt (D.C.), R3;
- One Lynch, 100,000-ohm resistor, R4;
- One Lynch, 10,000-ohm resistor, R5;
- One Lynch, 500-ohm resistor, R6;
- One Electrad, 150-ohm resistor, R7;
- One Electrad, 750-ohm resistor, R8;
- One Lynch, 75,000-ohm resistor, R9;
- One Van, 100 ma. shunt (A.C.), R10;
- One Van, 500 ma. shunt (A.C.), R11;
- One Clarostat, 50-ohm resistor, R12;
- One Lynch, 4,500-ohm resistor, R13;
- One Electrad, 100-ohm resistor, R14;
- One Electrad, 100,000-ohm variable resistor, RV-1;
- One Electrad, 1,000-ohm variable resistor, RV-2;
- One Electrad, 50,000-ohm variable resistor, RV-3;
- Two Electrad, 400-ohm variable resistors, RV-4, RV-5;
- One momentary closing switch, SW;
- One Best type 4-NSDK switch, SB;
- Eight Inter-Air tip jacks;
- Eight Special Fuller lugs, with 1/4-inch hole to fit tip jacks;
- One United bakelite panel, 5 1/4 x 7 1/4 x 3/16-inch.

ANALYZER ADAPTER

(Continued from page 278)

way through. See Fig. 2A and 2B.

These handles are to be fitted with their heavy end into the tube bases for a length of 3/8 inch and fastened with three small wood screws. On the other end secure the tube caps by means of small wood screws.

The remaining ends of the cables receive the multi-plugs having a corresponding number of prongs. See Figs. 3A, 3B, and 3C.

As a final check-up, plug one cable into the adapter box and with a continuity tester, probe between the socket on the box and the prongs on the other end of the cable. When reading plate current, for instance, place the two milliammeter prods on the two tip jacks connected with a switch, in this case, on No. 4 and No. 11. No. 11 being red, receives the positive prod. Then open switch C and plate current will be read.

Filament voltage will be read across Nos. 13 and 14; and filament current will be read across Nos. 6 and 12. All switches should normally be left closed, to be opened only when reading current or when using the outfit as a tube tester.

In the latter case, open switch II and insert one or two "C" batteries in connection with a S.P.D.T. switch, according to Fig. 3D, into Nos. 5 and 12; No. 5 receiving the negative wire. A milliammeter is placed in the plate circuit (between Nos. 4 and 11) and the deflection noted.

In testing tubes, a number of them known to be good should be tested first, in order that some idea as to the proper deflection may be gained.

Various other uses will suggest themselves as the Service Man becomes used to the adapter, such as cathode leakage test, using a 2.5-volt filament transformer, a 45-volt "B" battery and a microammeter. Tubes may also be tested for gas with a microammeter in the grid circuit. Resistance measurements may be taken between the various jacks and the chassis of receiver.

List of Parts

- One five-wire cable, 4 feet long;
- One six-wire cable, 4 feet long;
- One seven-wire cable, 4 feet long;
- One International Air multiplying No. 84, with five plugs;
- One International Air multiplying No. 85, with six plugs;
- One International Air multiplying No. 86, with seven plugs;
- Three hardwood file handles, at least 1 1/4 inches in diameter;
- One four-prong tube base;

(Continued on page 311)

The **TRANSMITTER UNIT**
with 100 Uses ~ **95c**

The Skinderviken
Microphone Button

MAKE YOUR OWN LAPEL MIKE

OTHER USES:

RADIO AMPLIFIER PHONOGRAPH AMPLIFIER
DETECTOGRAPH TELEPHONE AMPLIFIER
(Dictograph) LOUD SPEAKER AMPLIFIER
STETHOSCOPE CRYSTAL SET AMPLIFIER
HOME RECORDING OUTFITS

One Unit 95c; two for \$1.75
12-PAGE INSTRUCTION BOOKLET
containing suggestions and diagrams for innumerable uses, furnished with each Skinderviken Button.

This is the smallest microphone made, measuring only 1/4 inches in diameter. It is fitted with the finest polished carbon grains obtainable.

— ULTRA SENSITIVE —

EVERY AMATEUR SHOULD HAVE TWO OR THREE OF THESE MICROPHONE-AMPLIFIERS IN HIS LABORATORY

SEND NO MONEY

When the postman delivers your order you pay him for whatever you have ordered, plus postage.

PRESS GUILD, Inc. RC-11-32
16 Murray St., New York, N. Y.

Please mail me at once as many of the following Skinderviken Microphone Buttons as I have indicated.

One for 95c; Two for \$1.75;

Three for \$2.50; Four for \$3.20

I will pay the postman the cost of the items as specified, plus postage.

Name

Address

City..... State.....



96 PAGES
OF NEW DATA
HAVE BEEN
ADDED TO THE

OFFICIAL REFRIGERATION SERVICE MANUAL

To bring this useful service manual right up-to-date, Mr. L. K. Wright, the editor of the OFFICIAL REFRIGERATION SERVICE MANUAL, has added a wealth of material on new electric refrigerators, and older models as well, which are on the market. As usual every refrigerator has been accurately described from the viewpoint of servicing—diagrams to illustrate the essential parts, so simplified that repairs can easily be made. The addition of these new pages will not increase the cost of the book to those who order their copy now.

Here Are Some Of The Important Chapters:

- Introduction to the Refrigeration Servicing Business
- History of Refrigeration Fundamentals of Refrigeration
- Description of All Known Types of Refrigeration
- Motors
- Trouble Shooting
- Unit Parts, Valves and Automatic Equipment
- Makes and Specifications of Units
- Manufacturers of Cabinets
- Refrigerants and Automatic Equipment and Many Other Important Chapters

GERNSBACK PUBLICATIONS, Inc. RC-11
96-98 Park Place, New York, N. Y.

I enclose herewith my remittance for \$5.00 (check, stamps or Money Order accepted) for which you are to send me, postage prepaid, one copy of the OFFICIAL REFRIGERATION SERVICE MANUAL, together with the extra 96 pages of new material at no extra cost.

Name

Address

City..... State.....

CRAFTSMAN'S PAGE

(Continued from page 290)

tion as to the origin of the A.V.C. circuit in question.

I am sorry that the enclosed page from the April issue of RADIO BROADCAST (now deceased) containing this circuit is not marked as to the year, but am quite sure it was 1930. The article is entitled, "Automatic Volume Control," by A. C. Matthews, Jr.

You see, I have a sort of weakness for saving magazine material which looks especially good, and this one sure appealed to me as very interesting; I intended doing some experimental work with it, but for some reason or other just shelved it. I might mention that I am suffering from this same "saving weakness" in connection with RADIO-CRAFT.

GARTH OLER,
950 So. 22nd St.,
New Castle, Ind.

(Enclosed with Mr. Oler's letter was the page, from RADIO BROADCAST, to which he refers. (This page also was sent to us by other contributors.) In the article, the author quotes as his bibliography the January 1928, March 1928, and the March 1929 Proc. I.R.E.

Two final comments are printed below.—
Editor.)

Editor, RADIO-CRAFT:

The July, 1932 issue of RADIO-CRAFT contained letters by Mr. Nason and Mr. Goditus, both of these gentlemen handling a verbal spanking to Mr. Hryzink for his article on automobile volume control.

Mr. Goditus gives all the credit to Mr. Cherardi, while Mr. Cherardi, on page 561 of his "Radio Physics Course," credits Mr. A. C. Matthews, Jr., as having devised this control circuit; the diagram printed on page 562 originally appeared in RADIO BROADCAST magazine.

Mr. Nason admits that, "the material was not original with me," and therefore should not condemn Mr. Hryzink.

Mr. Nason's article, "A Simple Service Oscillator," on page 35 of the July issue looks familiar. Just open the O.R.S.M., Vol. II, to pages 22 and 113, and O.R.S.M., Vol. I, to page 76K and you will find the material to be the same as that used by Mr. Nason. Why doesn't Mr. Nason "donate a substantial portion of his award to the relief of indigent and broken-down Service Men"?

On page 30 of this same issue, Mr. Sayre enters an article on, "Improving the A.K. 35." This material also appears in the 1930 edition of Radio-News' "101 Hookups," page 15.

A previous winner in this contest, name unknown, took the prize money on an article showing how an A.C. "B" eliminator could be used in D.C. districts. I have before me a clipping from an old N. Y. Six radio section showing an identical diagram.

However, the above-mentioned articles, even though they have appeared before, are interesting enough to merit re-publication.

GEO. JEHL,
55 Osborne Ter.,
Newark, N. J.

Editor, RADIO-CRAFT:

The writer wishes to make the following comment regarding the letter of Mr. Jehl.

If he will examine the title page of the O.R.S.M., Vol. II, he will find that I was an Associate Editor of that publication. If the publishers of RADIO-CRAFT deem it advisable to pass on this information to those readers who have not purchased the Manual, I see no reason for complaint on that score.

My complaint was based on the fact that the exact values of resistors, etc., which were employed in my article were employed in Mr. Hryzink's entry—my notes, in turn, were taken from my memorandums on A.V.C. circuits. My own material came from RCA and Philco and was not original in entirety save insofar as my explanation of the properties of the circuits were concerned.

There seems to be a slight difference between a technical dissertation which attempts to cover the entire field of A.V.C. methods, and a simple contest entry which, moreover, is material drawn directly from the same publication.

C. H. W. NASON.

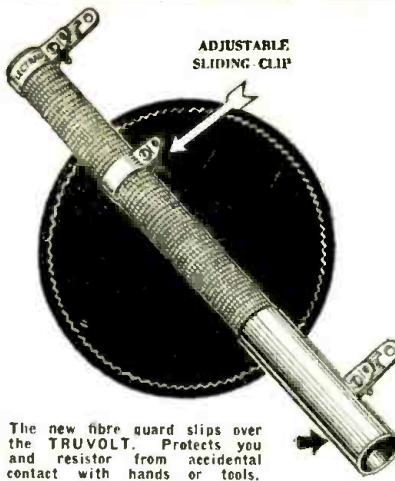

The new fibre guard slips over the TRUVOLT. Protects you and resistor from accidental contact with hands or tools.

IMPROVED! for Greater CONVENIENCE

- TRUVOLT Resistors offer several *exclusive* advantages:
- 1—Patented construction permits larger wire, giving longer life and greater heat radiation.
 - 2—TRUVOLT construction gives better electrical contact.
 - 3—TRUVOLT spiral winding of the resistance wire provides finer adjustment.
 - 4—Adjustable sliding clips may be added, removed or set for any desired voltages.
 - 5—Every TRUVOLT Resistor has a full-length fibre guard. Prevents injury from tools.
 - 6—TRUVOLTS are the most economical and adaptable of all resistors.

STANDARD VOLUME CONTROLS

Instantly Changed to Use Power-Switch

All ELECTRAD STANDARD VOLUME CONTROLS are now instantly convertible to use a power-switch, merely by removing the end cover and snapping the cover, with switch attached, in its place. All ELECTRAD STANDARD VOLUME CONTROLS are now equipped with long aluminum shafts—easy to cut to any desired length—less time; less trouble.

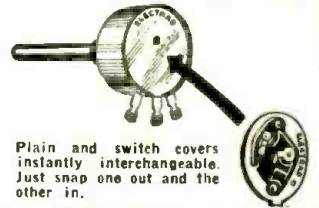

Plain and switch covers instantly interchangeable. Just snap one out and the other in.

RESISTOR REPLACEMENT HAND BOOK

The most valuable resistor replacement guide ever compiled for service men and experimenters. Accurate, loose-leaf information on resistor values for all receivers. Kept up-to-date by four supplements a year. Sold on a 10-day trial, money-back guarantee.



\$1.00
a year,
with 4
supplements.

Write
Dept. RC-11
for Complete
New Catalog.

175 Varick St., New York, N.Y.

ELECTRAD
INC.

BOOK BARGAIN

Special Sale of
2000
S. GERNSBACK'S
RADIO ENCYCLOPEDIA
1st Edition

WE have on hand 2000 UNBOUND copies of this valuable book, and we are disposing of same at a price which does not even cover the cost of the paper and printing. The books are in first-class condition, sewed and stitched but unbound. You can put a cover on yourself or your bookbinder can do it at a very small expense.

This indispensable radio reference book contains over 1,930 definitions, 549 photo reproductions, drawings, and diagrams. The size of the book is 9 by 12 inches. It contains 168 pages, and is printed on the finest book paper obtainable. Practically every definition in the book is illustrated, and all the subjects are arranged in alphabetical order with numerous tables and charts distributed throughout the text.

PRICE PER BOOK, 69 CENTS

Do not send any money. We will send you the book and you pay the postman 69c plus postage. Cut out coupon, paste on postal card, and mail to:

ISKOR PRESS, Inc., 19 Park Place
New York, N. Y.

BARGAIN ORDER BLANK

ISKOR PRESS, Inc.
19 Park Place
New York, N. Y.

Please mail me S. Gernsback's Radio Encyclopedia, 1st Edition; Unbound. I will pay Postman 69c plus postage.

Name
Address
City State

ATTENTION!

Servicemen! - Amateurs!

Don't waste your money on surplus radio parts when we can supply you with NEW and Nationally known makes at lower prices and guaranteed. You save money by buying from us.

R.C.A. Single Button Hand-mike—with cord \$2.95
Elkon dry electrolytic condenser 8 mfd.39
Sprague wet electrolytic conds. 8 mfd.39
Potter .25 mfd. By-pass conds.17
1grad .25 mfd. conds. for Sparton radios43
1grad 1.0 mfd. conds. for Sparton radios69
Mershon electrolytic conds. wet type—lowest prices!

5-prong wafer type sockets..... .09

Clarostat, Electrad, Centralab, Weston, Jewell, Readrite, Supreme, Shallcross, Hammarlund, Cardwell, Pilot, Speed, IRC Resistors, Aerovox, De Forest, RCA, Thordarson, Jefferson, Littlefuse, Universal Microphones, Signal Keys, Sangamo, Bradlevstat, REL, Silver-Marshall, Remler, Ward-Leonard, Olmitte resistors, Escoc Generators, Flechtheim, Dubilier, Tobe, etc.

We also stock a complete line of Power Transformers, Condenser Blocks, Public Address Systems, and other replacement parts for all radios. Our prices are lowest!

Write for Free Bulletin.

20% deposit with all orders—balance, C. O. D. Postage extra. Any size order accepted. Shipments made to all parts of the world.

MAURICE SCHWARTZ & SON

710-12 Broadway Schenectady, N.Y.

Announcing the



1933 Official Radio Service Manual

\$5.00

OVER 2,000
ILLUSTRATIONS

OVER 700 PAGES

9 x 12 INCHES

FLEXIBLE
LOOSELEAF
LEATHERETTE
COVER

The importance of the last two OFFICIAL RADIO SERVICE MANUALS to those engaged in the Radio Industry has been shown by the fact that over 52,000 copies of both editions have been purchased and are in use by manufacturers, jobbers, dealers, Service Men and experimenters. Incessant demands have encouraged us to publish a new and bigger *Service Manual* for 1933.

The new manual will not contain so many full-page illustrations as in the past for the reason that not as many new sets are being put out at present, but will have in its contents important information that has not yet appeared in print. This new "dope" is invaluable to radio men. Stress has been emphasized on giving only practical material, not complicated theory. It is bound to save time and money for everyone.

The simplicity in the makeup of the 1933 Manual makes information easy to find, accurately and quickly. As in the past the size will be 9 x 12 inches, with flexible, looseleaf leatherette cover.

Many additional features will be included in the new manual. The FREE QUESTION AND ANSWER SERVICE which was extremely popular in the previous edition will also be maintained. We assure you that the 1933 OFFICIAL RADIO SERVICE MANUAL will be a revelation in radio literature.

Advance orders are now being accepted at the price of \$5.00. Take advantage of this low price—send your order today. Be among the early ones to get a copy from the first printing. Checks or money orders accepted—register letter if it contains cash or unused U. S. Postage Stamps.

The following are partial contents of the 1933 Manual:

- Complete operating notes, and hints from actual experience with radio receivers in the field, collected by practical Service Men all over the country.
- Complete actual, pictorial views of hundreds of commercial receivers with additional schematic diagrams. Location of parts on the chassis are shown, and where important adjustments must be made. This section alone is worth the price of the book.
- Values of all intermediate frequencies used in superheterodynes, and a complete section of valuable service data on superheterodynes.
- Values of resistors and condensers, to aid in replacement work.
- Latest information on combination long- and short-wave receivers, short-wave adapters and converters.
- How to tune and service short-wave receivers for best results.
- How to use the most modern servicing instruments.
- Complete section showing how the Service Man can build himself service instruments, oscillators, etc., at very low cost.
- Complete section on the construction of all test equipment, including high- and low-frequency oscillators, tube checkers, ohmmeters, etc.
- Tube-chart information on all new and old tubes, in handy form for quick reference; indicating socket connections and operating values, thereby preventing confusion.
- An entire section on money-making suggestions for Service Men, written by the Service Men themselves who have made a success of the business; giving you short cuts and commercial information on how to get the most out of the servicing game.
- Service information on interference elimination, with practical data and many examples of interference prevention.
- Automobile radio installation and servicing—hints on automobile radio in general.
- Complete data on servicing all known, commercial, automobile receivers with short cuts to get quickly at the seat of the trouble.
- Service kinks, servicing short cuts, and miscellaneous servicing information.
- A complete section of various radio tables of every imaginable kind, in constant use by up-to-date Service Men.
- A large section giving complete technical data on meters of every kind pertaining to servicing in general.
- Complete index and cross-index to make it easy for you to find almost anything pertaining to service *instantly*.

FREE
QUESTION
AND
ANSWER
SERVICE

In every copy of the 1933 Manual, 24 coupons will be found, which will entitle you to 24 thorough and complete answers by mail on servicing and operating on any of the sets or circuits mentioned in the manual, as well as any others not mentioned, for which you might have need. This service alone is worth \$6.00. But it is absolutely free to manual owners.

GERNSBACK PUBLICATIONS, Inc.
96-98 Park Place, New York, N. Y.

I am enclosing herewith my remittance of \$5.00 for which you are to send me one copy of the 1933 OFFICIAL RADIO SERVICE MANUAL at the price of \$5.00 each. Checks or money orders accepted. Register letter if it contains cash or unused U. S. postage stamps.

Name

Address

City..... State..... RC-1132

THE OFFICIAL RADIO SERVICE MANUAL
FOR 1933 COMES TO YOU COMPLETE
THIS YEAR—NO SUPPLEMENTS
MAIL COUPON NOW

MORE CRYSTAL SPEAKER INFORMATION

In the July issue of this magazine there appeared a description of a crystal reproducer having very unique and desirable characteristics. Because of the excellent response received, the author, Mr. C. B. Scott, presents below some additional material. Refer to the figures in the article.

Recently, radio manufacturers have recognized the fact that there are certain advantages to be had from the use of two reproducers of slightly different characteristics, operating from the same source. This has come to be known as the "dual speaker" system.

The "crystal" reproducer, which is a capacitive type of unit, is now being used in conjunction with dynamic or inductive types to increase the acoustical range, improve the power factor, and help to keep the load impedance constant at all frequencies.

Reproducer (mounted on a 44 x 44 in. baffle, Fig. 2, shows the output curve obtained when using one "crystal" and one dynamic unit, in dual-combination. When used in this way, it is only necessary to connect the "crystal" reproducer across the primary of the output transformer T.

When the two reproducers are used in this manner, a phase displacement occurs between them which has been found to improve the quality of reproduction. Of course it makes a difference in which way the two reproducers are connected ("phased") with respect to each other, but the best method can easily be found by reversing the leads. If it is necessary to change the frequency characteristics of the "crystal" unit, a small condenser in series will cut the low frequency response, or used in parallel will cut the response at high fre-

quencies.

Theatre Reproducers

In some cases such as in theatre work, it has been found desirable to add a second "crystal" reproducer with a special hard cone in order to extend far enough into the higher frequencies to reproduce various over-tones which the sound film can produce better than the ordinary radio set. This means that the customary dip, which occurs with the use of dynamics alone between one and two thousand cycles, is completely smoothed out. Fig. 4 shows results obtained by the use of one dynamic and two "crystal" units.

The combination of such "inductive" and "capacitive" reproducers has another very desirable characteristic when used in connection with pentode-type tubes. These have a high percentage of second and third harmonics, unless worked at a "constant output." Therefore, the use of the speaker combination mentioned entirely does away with the objectionable content of this type of tube.

For the amateur, it is entirely possible to construct a reproducer with the same motor element which is used in the Type R 95 ensemble, and it will be found, when connecting the electrodes of the crystal element to the correct output hookup, that the crystal in itself forms a small speaker! It is only necessary then to provide the proper mechanical amplification of the vibration of the crystal and a reasonable amount of baffle (for bass reproduction) to construct a good experimental reproducer. These elements can likewise be used for reproducing supersonic frequencies for various purposes.

SERVICING AVIATION RECEIVERS

Additional information concerning the article "Servicing Aviation Receivers," which appeared in the July issue of RADIO-CRAFT is appended below in response to a great many readers who have read the article and desired to more fully acquaint themselves.

As for adjustments to control elements:

Do not attempt to make an adjustment on the contact gap of the *cutout*, because there is no adjustment. (The *cutout* is shown on the right hand side of Fig. C.)

You can adjust the gap on the *voltage regulator contact* by means of an adjusting screw, on which the fixed contact is held. Merely loosen the locknut and set the clearance at from .03- to .04-in. by screwing the contact screw in or out as necessary. And don't forget to set up on the locknut afterwards. (The voltage regulator is shown on the left-hand side of Fig. C.)

Adjusting the "current limiter" is about the last thing you will be called on to do, but if this should become necessary run the generator at approximately 2,200 R.P.M. The voltage regulator contact should then be kept closed by pressure of the finger (to prevent it from operating), and the charging rate of the generator observed. This rate should be equivalent to the full rated capacity of the generator when the limiter is correctly adjusted. If you want to increase the output, turn the adjustment ratchet to the right; to decrease, turn it to the left. This adjustment should also be securely locked so that the setting will remain permanent. (The current limiter is shown in the center of the control box, Fig. C.)

So much for the more superficial servicing work. Before proceeding with any trouble shooting, be sure that all wiring connections are properly made and that the circuits are intact, the generator line switch and generator field switch both closed. Particular attention should be paid to the battery connections as these are the ones which are most likely to become corroded in service.

Suppose that the generator fails to supply voltage. First notice the voltmeter reading with the generator running at its normal operating speed. The voltmeter should show from 14 to 15 volts. If it does, it is O.K. and the trouble is in the *cutout*. Look for dirty or oxidized contact points in the control box. If and when they are O.K., determine whether the *cutout* setting is too high. The

correct value should be 13½ volts. Test the *cutout* shunt winding for open circuits.

If your voltmeter only shows about 2 volts output—and sometimes it does—there may be one or more of the following defects present: (1) dirty regulator contact points; (2) worn brushes; (3) loose connections; (4) brushes binding in brush boxes; (5) dirty commutator. The remedy for these conditions is fairly obvious and can undoubtedly be successfully undertaken by the average Service Man.

Generator as Motor

If trouble still exists, run the generator as a motor. To do this connect a jumper between the plus armature and plus field connection, and then connect the plus generator terminal to the positive, and the minus terminal to the negative post, respectively, of a 12-volt storage battery. The generator should draw 25 amperes and run freely. If it will not perform, you may proceed to test for open field circuit, grounded field circuit, open armature.

To test for open field, connect the two terminals of a battery and light circuit to the two generator field terminals. The lamp should light if there is no open circuit. To test for a grounded field, disconnect the field terminal from the A terminal post and connect one end of a lamp-and-battery circuit either to this loose field terminal or else the F terminal post. Then connect the other end of the lamp and battery circuit to the generator frame. If the fields are grounded, the lamp will light.

An open armature is rarely found to be the trouble and when this trouble does develop, it is usually discovered that the solder which holds the armature wires in place on the commutator has been melted by excessive heat. If the generator pulls more than 25 amperes while being run as a motor, and groans considerably, it is a pretty good sign that the armature is shorted.

The propeller, of course, is turned over by the impact of air due to the plane being in flight. Note in Fig. 4 that the propeller is held in position by the spring D. The centrifugal force due to the propeller revolving, carries the flyweights C out from the center, until they act as a governor. The governor spring adjustment is provided to increase the tension of the governor spring for each desired R.P.M., maintaining the generator speed constant throughout extreme fluctuations in



Order a Set of Centralab Motor Radio Noise Suppressors



	Retail Price	Your Price
Set of 5 for 4 cylinder car	\$2.00	\$1.10 net
Set of 7 for 6 cylinder car	2.75	1.50 net
Set of 9 for 8 cylinder car	3.50	1.90 net

They're 50% to 500% more efficient in reducing spark noises. We're having a real job keeping up on production! They must be good... that's the only way we can explain their increasing popularity.

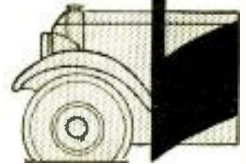

Centralab

CENTRAL RADIO LABORATORIES

930 E. Keefe Ave. Milwaukee, Wis.

Coat Lapel Microphone Micromike*



Front View

The ideal microphone for all types of Public Address Systems or any acoustical application such as broadcasting or home recording. Described in previous issues of Radio-Craft by Dr. Saxl.

Small in Size—Light in Weight

Perfect Reproduction

Introductory Price.....\$10.00

Bulletins on request

RADIO RECEPTOR CO., Inc.

Sole Manufacturers

110-7th Avenue New York, N. Y.

*Registered U. S. Patent Office.

TEST ALL THE NEW TUBES

with the RADIO CITY MULTIDAPTER



and your present tube checker or analyzer. All of the new 5-6- and 7-prong tubes may be tested, as well as new tubes that will be brought out in the future.

Brings your obsolete equipment up to date. It provides for the future. It is in one. Test the second plate of '80, etc.

One MULTIDAPTER does all—permits many miscellaneous tests—simple to use.

Sent complete with instructions and tube testing information service for \$2.75 or
SEND NO MONEY—Simply mail coupon and pay postman upon delivery.

RADIO CITY PRODUCTS COMPANY Dept. RC 11
48 West Broadway, New York, N. Y.

Please send me one MULTIDAPTER complete with tube testing information service coupon. I will pay the postman upon delivery.

NAME _____
ADDRESS _____
CITY _____ STATE _____

CHEMISTRY

A New Plan to Become a TRAINED CHEMIST

\$6.25

By taking only one step at a time—as your means permit—you can give yourself the benefit of the most complete, thorough-going, up-to-the-minute education for skilled well-paying professional work, in the most fascinating of all scientific fields, through our famous

COURSE IN PRACTICAL CHEMISTRY

Write TODAY For Information
CHEMICAL INSTITUTE OF
NEW YORK, Inc.

Founded 1921

HOME EXTENSION DIVISION
19RC Park Place New York, N. Y.

\$5,000 WILL BE PAID TO ANYONE WHO PROVES THAT THIS IS NOT THE ACTUAL PHOTO OF MYSELF SHOWING MY SUPERB PHYSIQUE AND HOW THE ROSS SYSTEM HAS INCREASED MY OWN HEIGHT TO 6 FT. 3 3/4 INCHES. HUNDREDS OF TESTIMONIALS. CLIENTS UP TO 45 YEARS OLD GAIN FROM 1 TO 6 INCHES IN A FEW WEEKS!

No Appliances—No Drugs—No Dieting. ROSS SYSTEM NEVER FAILS. Fee Ten Dollars Complete. Convince Testimony and Particulars 5 cent stamp. Allow time for return mails across the Atlantic. G. MALCOLM ROSS, Height Specialist, Scarborough, England, (P. O. Box 15).

First in 1907
First To-day

FREE! The RADOLEK CO

**111 Canal Station
Chicago, Ill.**

Our new 1932 Radio Serviceman's Wholesale Price Guide will be sent to you upon request. Write, using your letter-head or business card. Send for it today.

KEEP UP WITH RADIO

NEW General course at New York Resident School. Includes all branches of radio, as well as Broadcasting, Sound Pictures, Servicing, Aviation and Marine Operating. Also specialized courses at New York and Chicago schools. Catalog on request.

RCA INSTITUTES, Inc.
Dept. RT-11 75 Varick St., New York



SERVICEMEN-DEALERS

Write for our Catalogue
Complete Stock of NEW
Radio Replacement Parts
Hard to Get Parts—We have them. Send us your repair work for estimate.

Grant Radio Laboratories
6521-C South Halsted St., Chicago, Ill.

the air speed of the plane in flight. For this reason, it is not necessary to have a voltage regulator device such as was explained for use with the engine driven generator.

If the generator runs either too fast or too slow, thus delivering voltage that is too high or too low, adjust the governor spring adjustment at E, Fig. 4. That is all you have to remember about the Deslauriers "head."

It is not uncommon for noise to develop as the filter sometimes leaks or opens, causing receiver noises to develop. Therefore, when receiver "noise" is the complaint, the Service Man should check the filter circuit of the dynamotor.

Which brings us back to receivers. To locate troubles in aviation receivers, the circuits should be known. There are only three receivers that are widely used in aviation and these receivers will be described in a forth-

coming issue of RADIO-CRAFT. If you want to learn more about servicing aviation radio sets, look for this article.

In the meantime, do not balk at any aviation servicing work that comes your way. Tackle any job you can get and don't look for heavy trouble because the faults that develop in airplane radio installations are likely to be superficial.—troubles that you, as a "broadcast" radio Service Man, can easily discover and correct.

Remember the case of the Lindberghs. When they first took off, on their flight across the United States and the Pacific, they had to turn back because "the radio set wouldn't work." It was a borrowed set. A switch was open where the Lindberghs didn't know there was a switch—and here they couldn't see it. A Service Man pointed this out and a few other things to Mrs. Lindbergh and after that the set stood up fine all the way to Japan.

HOW TO USE A SET ANALYZER

In the first part of a series of articles "How to Use a Set Analyzer," by F. L. Sprayberry, which appeared in the July issue of RADIO-CRAFT, advice was given as to the theory of set analyzers. Some additional data appears below.

After seeing that low plate voltage is not due to tube elements being shorted, you are ready to investigate the circuit further for possible defects.

For instance, the plate voltage may be low and yet not be due to shorted tube elements. There usually are one or more bypass condensers associated with the plate circuit, either in the receiver proper or across the voltage divider in the power pack, and as these often puncture or break down (particularly in the early makes of sets), the result will be a reduction in the value of the applied voltage.

Then again, a resistor is always used to reduce the plate voltage to the correct value, and if this becomes grounded, the voltage will be lowered.

We do not always find the trouble in the stage under test. In most receivers, several tube circuits are "common" with respect to their connection to a source of voltage; consequently, a ground or short in another stage common to the one under test may be causing the trouble in that stage.

High Plate Voltage

High plate voltage may be caused by one or more weak tubes, or an open in the plate circuit proper or the plate-return circuit to the cathode. If in Fig. 1E, resistor R becomes open, plate voltage will not be measured by the analyzer. However, if the external test leads of the voltmeter are used, one lead being on the plate of the tube and the other on the chassis of the receiver, high plate voltage will be indicated.

If the plate circuit is open, no plate current will be indicated on the milliammeter. The open may be in the cathode resistor or its circuit, while continuity test will show whether it is between the power pack and the tube socket. If the cathode and plate circuits are O. K. from tube socket to power-pack terminals, then the trouble must be in the power pack.

If voltage cannot be measured on any of the tubes, examine the center-tap to the high-voltage winding, and the lead to the rectifier filament circuit. Either one of these connections may be poorly made; or the circuit may be entirely open. (Directions for test of the power pack will be given later.)

If condenser C in Fig. 1F becomes shorted, the resistor R will probably burn out due to the high current which then will flow through it.

Many T.R.F. receivers using screen-grid tubes have the volume controlled by varying the screen-grid voltage; therefore, always have the volume turned on full when making measurements. If there is little or no screen-grid voltage, the plate current will be low, the plate voltage will be high, and the control-grid voltage will be low or entirely lacking. It is easy to see that abnormal conditions in one circuit cause abnormal conditions in other circuits to which it is related. However, if measurements are made on all the circuits of

a tube it is generally possible to determine the cause of the trouble; and when this is eliminated abnormal conditions in other circuits automatically adjust themselves to normalcy.

What has been said about control-grid circuits is applicable whether the tube is of the three-element "general purpose" type, a four-element "screen-grid," or a five-element "pentode."

Although the variable-mu type of screen-grid tube ordinarily requires a circuit design which will permit a high, adjustable voltage to be applied to the control-grid-return circuit, the tube test procedure is the same as for regular screen-grid tubes.

The screen-grid element in pentodes of the '47 type is connected to what is ordinarily the cathode terminal of a five-hole socket, which makes it difficult to measure on an ordinary set analyzer the pentode screen-grid potential of 250 volts. However, although most set analyzers are not equipped to measure 250 volts positive at the cathode terminal, this is taken care of nicely on the Jewell 444, as it will measure both negative and positive values at the cathode terminal.

Generally speaking the circuits of the pentode tube are subject to the same troubles as are other tubes. Shorted tube elements will cause high plate current and low voltage. Grounds or shorts external to the tube circuits will cause abnormal measurements and by making continuity tests on the circuit and individual parts of the circuit having abnormal measurements, the trouble will be located. The screen-grid of a pentode tube has high current compared to other types of tubes incorporating a screen-grid and may run as high as ten or twelve milliamperes. In a screen-grid tube this would indicate a shorted screen grid element, but in the pentode it is a normal condition.

Relation of One Circuit to Another

Particular attention should be given to the dependence of the screen-grid, cathode and control-grid voltages, on the primary source of voltage; and to the fact that an abnormal potential in any circuit will always show up, one way or another in the other circuit with which it is interconnected.

It is the Service Man's job to be able to recognize these peculiarities and take advantage of them, thereby saving time. A Service Man who knows his set analyzer and circuits will rarely run into trouble that he cannot correct. If these fundamental principles are followed by the average Service Man, when testing a faulty receiver he will in 99 cases out of 100 be successful with his jobs.

(If this article by Mr. Sprayberry has been not merely read, but studied, the technician will find that the information is readily adaptable to newer tubes, since these fundamental principles of testing apply to vacuum tubes of practically every type. Thus, it should be convenient to test receivers incorporating the '41, 41, 46, 57, 58, 82, G-2-S diodiode, '95, and the '34 type tubes—note in some instances, the absence of the apostrophe which denotes an additional letter, or letter and number prefix—recently described in RADIO-CRAFT, merely by comparing the electrical

(Continued on page 311)

BOOK REVIEW

N.R.I. ADVANCED AIR CRAFT RADIO COURSE

The advanced air craft radio course offered by the National Radio Institute is intended for experienced radio technicians who desire specialized training in this interesting field. It is divided into twelve lessons, several of which are devoted to aeronautics in general. The student is thus enabled to speak the language of the flier, an advantage that he will find very valuable in any airplane radio work that he will undertake.

The individual texts are arranged as follows:
 1 VA: *The Application of Radio to Air Craft*: The first book of the series covers the use and importance of radio in air craft and, the duties of aircraft radio men. The back part gives a few fundamental facts about flying machines, defines important terms, describes the operation of the commercial radio beacon and lists the requirements for approved types of airports.

2 VA: *Airplane Radio Equipment*: The rigid requirements for airplane radio equipment are covered in this text. Detailed descriptions of each element in the installation are given, with the means used to gain maximum effectiveness under the strict space and weight limitations naturally imposed on the apparatus. The importance of thorough bonding of all the metal parts of the plane, to eliminate local noise and interference, is especially emphasized. Installation methods are also discussed.

3 VA: *Air Craft Radio Power Supplies*: The third lesson is devoted exclusively to power supply equipment, the design of which has been more of a problem than the radio receiving and transmitting sets themselves. Power units of four types are described: batteries, dry and storage; generators, wind and engine driven; dynamotors; rectifier. The last named type is particularly interesting, and is finding increased use for high power transmitters.

4 VA: *Fundamental Air Craft Radio Transmitter Circuits*; 5 VA: *Air Craft Radio Telephone Transmitters*; 6 VA: *Air Craft Radio Telephone and Radio Telegraph Transmitters*: These three lessons consider the basic nature of present day air craft radio transmitters, and treat in considerable detail with the actual design, circuit arrangement and construction of commercial equipment in common use on the civil airways of the United States. In the interest of completeness they also describe ground station equipment for communicating with planes in flight. While these two types of equipment are employed in the same service, the conditions of their use are so different as to require entirely different design considerations. The sections covering commercial equipment are particularly valuable because they include schematic wiring diagrams and practical data that the radio man will find highly useful.

7 VA: *Fundamental Air Craft Receiver Circuits*; 8 VA: *Air Craft Radio Receivers*: These two texts cover receivers with the same thoroughness that the three preceding lessons cover transmitters. The different phenomena encountered on the long and short wavelengths assigned to air craft are treated at length, as are the aural and visual methods of reception employed on the extensive radio beacon systems. Several of the most widely used commercial receivers are described in detail.

The last four texts are essentially aeronautical in nature. No. 9 VX: *Flight Principles*, is intended to give the student some idea, in a non-technical way, of why an airplane flies. It does not go into the subject very deeply, but is at least a beginning for the student aviator. No. 10 VX: *Air Craft Instruments*, describes the multitude of indicating devices that clutter up the control compartment. No. 11 VX: *Aerology and Meteorology*, deals with the general subject of the weather and its highly important relationship to flying. The title of No. 12 VX, *Air Traffic Rules*, is self-explanatory.

HOME EXPERIMENTS

(Continued from page 295)

photolytic cell and circuits showing various hookups, etc., the reader is referred to the booklet published by the manufacturers of this tube. The Arceturus Tube Company.

Looking for a GOOD S. W. Receiver?

Read This Buy This

Time tried and proven OK! Accepted as the OUTSTANDING VALUE today! Consistent reception of stations in all parts of the world. Quiet, ECONOMICAL, powerful, simple to operate, and INEXPENSIVE!

Higher priced receivers? They can give you no more! Cheaper sets? They simply can't be compared to ROYAL! We guarantee these ROYAL receivers to outperform any other set. Order your ROYAL today and if you are not entirely satisfied we will promptly refund your money. What could be more convincing!

Beautiful crackle finished metal cabinet—heavy metal chassis—full-vision ultra vernier dial—smooth regeneration control—single control tuning—for 20, 40, and 80 meter bands or from 14 to 200 meters (state choice.) The use of a 232 screen grid detector and a 233 power pentode amplifier gives extreme sensitivity and extraordinary volume with low filament and plate consumption.



The ROYAL STAR

(The famous model RP)
 A two tube unit with an enviable reputation! Uses a 232 super sensitive detector and a 233 power pentode..... **\$14.70**
 Set of Tubes \$2.55
COMPLETE KIT \$11.76

The ROYAL CHIEF

A three tube set embodying all of the well known superior features of the ROYAL STAR plus a stage of high gain screen grid radio frequency amplifier..... **\$17.64**
 Set of Tubes \$3.75
COMPLETE KIT \$17.64

The ROYAL OLYMPIC

The ROYAL CHIEF with an additional stage of audio amplification for super-dynamic power. THE ROYAL OLYMPIC makes new records!..... **\$20.58**
 Set of Tubes \$4.75
COMPLETE KIT \$17.64

HERE'S WHAT USERS OF ROYAL SAY: It's the sweetest little receiver I have ever used, barring none!... "I have different makes of SW sets, but the ROYAL Model RP gets more stations than any other set and with more pep!... "Received Spain and several VK's and ZL's through strong interference... "and have now heard broadcast stations in every continent... "I certainly congratulate you for putting the best little DX hound on the market within the reach of any ham."
 (Names on request)

HARRISON RADIO CO. Dept. R-11, 142 Liberty St., New York City

ADAPTERS

(Continued from page 281)

in the '26 checker socket. This adapter has a filament series resistor of proper value.

No. 972RI, Fig. 56, checks the Western Electric type 215A peanut tube in the above models of Jewell checkers. Provision is made for obtaining the proper filament voltage with this adapter.

No. 944IS, Fig. 44, is used in Jewell models 210, 214, 533, 534, 535, 536, 538, 540, and 675 to check the overhead heater type tubes. No. 429, Fig. 40, is used on any Jewell checker for checking the UV199 tube.

No. 979WE, Fig. 57, is used above with Jewell models 210, 214, 538 and 540 for checking the Western Electric 205D tubes. When used with the No. 954 this adapter will check the 205D tube in Jewell models 209, 533, 534, 535, 536 and 675.

No. 967, Fig. 43, is used with any Jewell checker for checking UV-200A and UV201A tubes.

No. 954KPC, Fig. 15, is used with models 209, 210, 533, 534, 535, 536 and 675 for checking the GA 5-volt pentode.

No. 954, Fig. 58, is used with Jewell model 209 to check the '36, '37, '38, '39, 44, '64 '65 and '68 tubes and in the 210 checker to check the above tubes excepting the '37 and '67 which do not need an adapter.

No. 964KGG, Fig. 59, is used with Jewell model 209 checker for testing the Wunderlich "B" tubes and the 69. Use in '71 socket.

No. 964KSP, Fig. 60, is used with Jewell model 209 checker for testing the 41, 42, PA and 1P2II tubes.

No. 965CG, Fig. 14, is used with Jewell models 210, 214, 533, 534, 535, 536, 538, 540 and 675 for checking the 41, 42, PA and 1P2II tubes.

No. 964KSI, Fig. 61, is used with Jewell model 209 to check the 89 tube.

No. 965KS, Fig. 16, checks the 89 in Jewell models 210, 214, 533, 534, 535, 536, 538, 540 and 675.

No. 944GL, Fig. 62, checks the 865 tube in Jewell models 210, 533, 534, 535, 536 and 675.

No. 975KP, Fig. 33, checks the new seven-prong power amplifier with any Jewell tube checker.

SERVICE FORUM

(Continued from page 285)

specified when connected across the circuit to be measured; note that the filament current should not be turned on unless the input is connected to something. (Of course, a meter of lower range would go off-scale; the input potential must not be too great; the grid leak must be approximately correct; and the tube must have normal characteristics.)

C. W. MELOTTE,
 Melotte Radio Service,
 North Lawrence, N. Y.

(This circuit is reproduced in Fig. 1.—Technical Editor.)

2 GREAT BOOKS

THAT WILL BRING YOU MORE MONEY

RADIO PHYSICS COURSE
 by A. A. Ghirardi
 Author of the famous "Radio Physics" text book
 This radio course is a complete guide for the Radio Instructor
 92 pages
 Over 100 Illustrations
\$3.50 Postpaid in U.S.

RADIO SERVICING COURSE
 by Bertram M. Freed and A. A. Ghirardi
 Practical! Valuable! Check full of the technical information which every service man needs in order to keep up to date. 192 pages, over 100 illustrations.
\$1.50 Postpaid in U.S.

MAIL THIS COUPON AT ONCE!

RADIO TECH. PUB. CO., Dept. R.C. 11
 80 Fifth Avenue, New York City.

Enclosed find check, cash or money order for.....
 copies of Radio Physics Course at \$3.50 each, and
copies of the Radio Servicing Course at \$1.50 each. Check here for FREE circular.....

NAME.....
 ADDRESS.....
 CITY..... STATE.....

MAIL THIS COUPON AT ONCE!

RADIO TECH. PUB. CO., Dept. R.C. 11
 80 Fifth Avenue, New York City.

Enclosed find check, cash or money order for.....
 copies of Radio Physics Course at \$3.50 each, and
copies of the Radio Servicing Course at \$1.50 each. Check here for FREE circular.....

NAME.....
 ADDRESS.....
 CITY..... STATE.....

Servicemen & Dealers

You need Replacement Resistors that you can depend on—not space wound!
 ATLAS Wire Pack Wound Resistors are moisture proof—noiseless and accurate.
 Send today for our Free Bulletin showing complete line and discounts—A big money saver without any risk to you.

100% Guarantee
 Write Today!

Atlas Resistor Co.
 423 Broome St. New York City

BE "IN THE KNOW" ON RADIO

New things are happening in radio! Developments! Improvements! Keep up to date! RCA Institutes Resident Schools in New York and Chicago offer the opportunity. Illustrated book free.

RCA INSTITUTES, Inc.
 Dept. RT-113
 75 Varick Street New York

10 NEW BOOKS in the Radio-Craft

Presented on these two pages are the new books of the RADIO-CRAFT LIBRARY—the most complete and authentic set of volumes treating individually, important divisions of radio. Each book has been designed to give radio men the opportunity to specialize in one or more of the popular branches of the industry. The material contained in these books will increase your

knowledge; you will find them a real help in your work and they will contribute to your money earning capacity. Read these books during your spare time at home.

The authors of these books are well-known to everybody. Each one is an expert radio man; an authority on the subject—each is thoroughly familiar with the field which he represents.

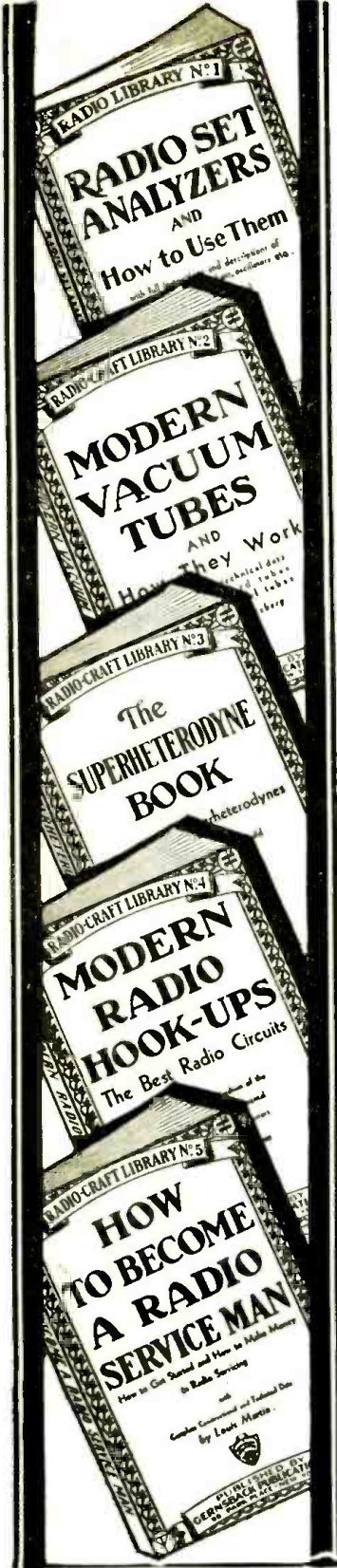

Book No. 1
RADIO SET ANALYZERS
And How To Use Them
With Full Instructions and Descriptions of Set Analyzers, Tube Checkers, Oscillators, Etc.

By **L. VAN DER MEL**
This book explains thoroughly the operation of set analyzers, tube checkers, oscillators and other testing equipment. For every radio man this book is extremely helpful. It covers every phase of testing and gives you valuable short cuts; completely illustrated with photographs and diagrams to facilitate the use of modern testers.

The following chapters briefly outline the contents: INTRODUCTION; THE ANALYZER; Fundamentals, Switches, A.C. and D.C. Voltmeters, Calibration and Design; TROUBLE SHOOTING WITH THE ANALYZER; Classification of Various Analyzers; Care and Maintenance; CONCLUSION.

Book No. 2
MODERN VACUUM TUBES
And How They Work
With Complete Technical Data on All Standard and Many Special Tubes

By **ROBERT HERTZBERG**
MODERN VACUUM TUBES describes the fundamental electron theory which is the basis of all vacuum tube operation, and goes progressively from the simplest two-element tubes right up to the latest pentodes and thyratrons. It is written in clear, simple language and is devoid of the mathematics which is usually so confusing. Valuable reference charts and characteristic curves of standard and special tubes are to be found, also diagrams of sockets and pin connections. Here are some of the chapters: The Edison Effect and The Electron Theory; Electron Emitters and the Ionization Effect; The Three-Electrode Tube; Vacuum Tube Characteristics; Four- and Five-Element Tubes; Light Sensitive Cells and Other Special Tubes.

Book No. 3
THE SUPERHETERODYNE BOOK
All About Superheterodynes
How They Work, How to Build and How to Service Them

By **CLYDE FITCH**
There is no more fascinating a subject in the large array of radio circuits than the famous superheterodyne circuit. Whether you are a Service Man or experimenter, first-hand knowledge about the construction of superheterodyne receivers is very important. The book on Superheterodynes gives underlying principles of their construction, right from the very first set made. The following is a short list of contents: Basic Principles of the Superheterodyne; The Oscillator; First Detector; Single Dial Tuning Systems; Intermediate Amplifier; Second Detector; Audio Amplifier and Power Supply; Commercial Superheterodyne Receivers; Servicing Superheterodynes.

Book No. 4
MODERN RADIO HOOK-UPS
The Best Radio Circuits
A Complete Compendium of the Most Important Experimental and Custom-Built Receivers

By **R. D. WASHBURNE**
It is fascinating to the experimenter, or even to the up-to-date Service Man, to take a commercial set and to change it into one using a famous hookup that is not found in any manufactured set. Many excellent circuits have never been commercialized, but limited only to home-set builders. Thousands of these popular circuits have been requested from time to time, and in this book we have included over 150 circuits, which include the famous Perdyne, Cash-Box A.C.-D.C. Set and others.

The circuits cover the following: Broad-band Receivers, All-Wave Receivers, Short-Wave Receivers, Converters and Adapters, Television Receivers, Home Recording Apparatus, Automobile Receivers, Audio and Power Amplifiers, Power Units and Miscellaneous Equipment.

Book No. 5
HOW TO BECOME A RADIO SERVICE MAN
How To Get Started and How To Make Money in Radio Servicing

By **LOUIS MARTIN**
The ambition of many men in radio today is to become a first-grade Service Man. It is not as difficult as one might believe, but it cannot be done in a few short months. Following very carefully the advice of Mr. Martin, who has dealt with the problems of thousands of Service Men, this book deals very carefully with the essential stages in the preparation for qualifying as a Service Man.

Here are the chapters: The Small Independent Service Man; Advanced Commercial Aspects; The Radio Set; Semi-Technical Considerations; Advanced Service Data. Each chapter is again subdivided to bring out in minute detail every point of importance.

Book No. 6
BRINGING ELECTRIC SETS UP TO DATE
With Pentodes, Multi-Mus., Dynamic Speakers—Complete Information How to Modernize A.C., D.C. and Battery Operated Receivers

By **CLIFFORD E. DENTON**
In this country there are over ten million electrically operated receivers that could be modernized—by placing in them new type tubes, new speaker equipment and other modern improvements. This business of improving old sets can go to the experimenters and Service Men if they will quickly jump into action.

Read in this book by Mr. Denton, how easily you can modernize any obsolete set, and with little additional costs. Here are the high lights of this book: Tubes Available for Replacements; Electrifying Battery Receivers; Use of the New 2- and 6-Volt Tubes; Operating Sets with Single Control; Conversion of A.C. Sets into D.C. and D.C. into A.C.; Replacing Output Tubes with Higher Output Tubes; Improving Old Supers; Loftin-White Amplifiers; Adapters and Their Use.

Book No. 7
RADIO KINKS AND WRINKLES
For Service Men and Experimenters
A Complete Compendium on the Latest Radio Short-Cuts and Money-Savers

By **C. W. PALMER**
It often becomes necessary for experimenters and Service Men to call upon their memory for some short cut or radio wrinkle that will solve a problem quickly. In business, "short cuts" mean time and money saved, and to the Service Man "time saved" means money earned. This book is a compilation of important radio kinks and wrinkles and discusses only such items as are constantly used today.

Here are some of the more important chapters: Introduction; Servicing Short-Cuts; Testing Equipment and Meters; Vacuum Tubes and Circuits; Volume-Control Methods; Amplifiers and Phonograph Reproducers; Power Supply Equipment; Coils and Tuning Circuits; Short Waves; Loud Speakers; Tools and Accessories.

Book No. 8
RADIO QUESTIONS AND ANSWERS
A Selection of the Most Important of 5,000 Questions Submitted by Radio Men During the Course of One Year

By **R. D. WASHBURNE**
There have been collected a wide variety of questions which have come into our editorial offices during the past two years, and only those whose answers would benefit the majority of men engaged in radio have been incorporated in this amazing question and answer book.

The tremendously long list of topics better explains the subjects which are treated. Here are the titles:

Radio Servicing; Receiver Design; Home Recording; Television; Sound Equipment; Short Waves; Antennas; Operating Notes; Test Equipment; Tubes; Ultra-Short-Waves; Police Radio; Reproducers; Superheterodynes; Automobile Sets; Power Parks; Automatic and Remote Control Devices; Aiding Procedure; Photoelectricity; Adapters; Measuring Apparatus; Band-Selectors; Converters; Public Address Equipment; Midjet Sets; Oscillators; Phonograph Pickups.

Book No. 9
AUTOMOBILE RADIO AND SERVICING
A Complete Treatise on the Subject Covering All Phases from Installing to Servicing and Maintenance

By **LOUIS MARTIN**
Automobile radios are up and coming, and someone has to service them properly. It therefore behooves you to read this immensely important new book on the art of Automobile Radio. The book is concise, and full of illustrations, photographs, diagrams and hookups.

Here are only a few of some of the really interesting chapters: Introduction; Automotive Radio Installations; Complete Descriptions of Commercial Automotive Receivers; Servicing Automotive Receivers; The Ignition System; General Service Considerations; Effects of Temperature on Power Supply; Conclusion.

Clip Coupon and MAIL!

GERNSBACK PUBLICATIONS, INC. 96-98 Park Place, New York, N. Y.

I have circled below the numbers of books in the RADIO-CRAFT LIBRARY, which you are to send me, and have deducted 20% for ordering five (5) books or more. I have included my remittance in full, at the price of 50c each, when less than five books are ordered. The amount of my remittance is..... (Stamps, checks or money orders accepted.)

Circle numbers wanted: 1 2 3 4 5 6 7 8 9 10

Name Address

City State RC-11-32



Library

This is perhaps the first real opportunity that you have ever had to build a radio library of books that are authentic, right-up-to-the-minute and written so that they are easily digested and clearly understood. Mail coupon on the opposite page for your books.

Book No. 10

HOME RECORDING AND ALL ABOUT IT

A Complete Treatise on Instantaneous Recordings, Microphones, Recorders, Amplifiers, Commercial Machines, Servicing, etc.

By GEORGE J. SALIBA

If there is one subject that is fascinating to every radio man, it is that of Home Recording. Of course, this volume is not all on "Home" recording, but the information contained therein is important to commercial radio men, studio operators, engineers and others interested in this phase of radio.

The art of recording and reproducing broadcast selections is becoming more important every day to radio men, experimenters and Service Men. Equipping dance halls, auditoriums, churches, restaurants and homes with public address and amplifiers brings many extra dollars and often an excellent income.

In this book are found such topics as: Short History of the Art; Microphones; Recording Amplifiers; Cutting Heads; Types of Records; Commercial Machines; Adding Records to Receivers; Studio Layouts; Mechanical Filters for Turntables.

BIG DISCOUNT OFFERED

In order to make it possible for everyone to buy these books, the fifty (50) cents price has been made uniform for all volumes. You can buy these books separately, but you should take advantage of our special offer:

When Five (5) Books or More Are Ordered Deduct 20% from Your Remittance

Simply fill in the coupon below, and mail it to us together with your remittance. Checks, stamps or money orders accepted.

All Books Uniform

The books in the new RADIO-CRAFT LIBRARY are all strictly up-to-date, and written by men who know their subjects. The volumes are all uniform size, 4 x 9 inches, and contain an average of 50 to 125 illustrations. Each book is printed on fine book paper, and no expense has been spared to make it an outstanding value, for its editorial contents as well as from the mechanical standpoint.



OPERATING NOTES

(Continued from page 284)

quite a substantial profit by revamping them in accordance with the circuit at B, in Fig. 5. The procedure is simple: The "antenna clarifier" is done away with, and a "tone control" is substituted in its place. The volume control, R, which fortunately has a value of 10,000 ohms, is shunted across the antenna and ground, and the center arm connected to the control-grid of the first tube, thus making that tube an untuned input unit. This system greatly increases the volume and eliminates one tuning control. We have remodeled quite a number of these sets in this manner and the owners have been more than satisfied with the results.

VELOCITY MICROPHONE

(Continued from page 299)

Convenience

The Velocity Microphone does not require a built-in or closely linked amplifier. Its output may be fed to an amplifier located several hundred feet away in the control room. Moreover, mixing of the outputs of several of these microphones is entirely practical. Such a low-level switching arrangement reduces the number of amplifiers required with consequent economies in speech input cost.

Since it requires no field or polarizing supply, the connections from microphone to control room are extremely simple—only a two-wire cable being required. The unit itself is relatively light. It may be quickly and easily removed from the stand and carried to another position. As the unit has mounted on it a receptacle into which the cable plug fits, it is unnecessary to drag the cable around with the unit.

LOOP ADAPTER

(Continued from page 302)

- Four Aerovox 1, mf. bypass condensers, type 261, C1, C5, C6, C7;
- Two Kenyon 300 henry audio chokes, type BC-3000—C11,3, C11,4;
- One Centralab 500-ohm potentiometer, P;
- One Kenyon power transformer, type B-4311—1T,—T;
- One Weston galvanometer, zero center, type 30-0-30 milliamperes;
- One Blau set of special aluminum shields;
- Five binding posts;
- Necessary wire, screws, etc.

The parts for the hum filter, if needed, consist of the following:

- One Kenyon 300 henry audio choke—type BC-3000;
- One Aerovox .00005-mf. fixed condenser.

SET ANALYZER

(Continued from page 308)

characteristics of these tubes, as indicated on a table of tube characteristics, and comparing these figures with the values indicated on the meters in the set analyzer; this will be true whether these figures are obtained directly, or through the use of special adapters designed to accommodate to the analyzer the particular connections of the tube under test. *Technical Editor.*

Now that we have covered the connection of meters to fundamental circuits,—just as the modern set analyzer connects them—the author will proceed to describe, in a forthcoming issue of RADIO-CRAFT, the quickest and most efficient manner of operating this up-to-date test instrument.

ANALYZER ADAPTER

(Continued from page 304)

- One five-prong tube base;
- One six-prong tube base;
- Three screen-grid caps;
- One box, about 7 x 6 x 1 inch;
- One panel, about 7 x 6 inches;
- One International Air plug extension No. 95, seven connections;
- Seven pair Yaxley insulated tip jacks, Nos. 1 to 14;
- Six toggle switches, D, E, F, G, H, I;
- One four-prong tube socket, A;
- One five-prong tube socket, B;
- One six-prong tube socket, C.

SAY!

If you service men haven't got around to handling Amplifiers and making Amplifier installations, you are passing up easy money! Take, for instance, your 50-year-old friend, the SAMSON ELECTRIC COMPANY, and its PAM-110, the marvel of all Class B Amplifiers. Here is the lowest priced unit judged by the amount of power (26 watts) per dollar cost.

Yes, sir, SAMSON has given you a fast one in the PAM-110—for 110 volt current, 50-60 cycles, with variable output impedance for voice coil, to line or to magnetic speakers and designed for operation with the SAMSON MIK-110 . . . a combined input mixer, input coupling device, and tone modifier.

Here's a chance to add to your line profit-making items which are gaining widespread attention.

SPECIAL OFFER: Our Bulletin RC1 covers the theoretical and practical uses of Class B Amplification and the complete story of the PAM-110 and the MIK-110. Send stamps, totaling 15c to cover the cost, and address:

R. W. COTTON

Samson Electric Co., Canton, Mass.
Member R.M.A. Mfrs. Since 1882

The New
SHALLCROSS
General Purpose Meter
No. 610

provides facilities for a wide range of electrical measurements not usually possible in one instrument. Employing a No. 610 Shallcross Resistor Kit and the Weston Model 301 Universal Meter, this combination meter measures:

- 4 D.C. Voltage Ranges
- 4 D.C. Current Ranges
- 4 A.C. Voltage Ranges
- 4 A.C. Current Ranges
- Resistance Measurements of 1 ohm to 3 megohms
- Inductance measurements, 1 to 10,000 henrys
- Capacity measurements, .001 to 10 mfd.
- Output Meter

Send 6c in stamps for Bulletin 152-P which contains a diagram of this circuit and information on its construction.

Super **Shallcross Mfg. Company** **RELIABLE**
ELECTRICAL SPECIALTIES
700 PARKER AVENUE
Collingdale, Pa.

Measuring Soldering Iron Temperature

By ARTHUR VAUGHN

Knowledge of the temperature of a soldering iron is useful in a number of ways. Using an iron of correct temperature for a given job results in more uniform work; the iron need be neither too hot nor too cold. After the iron has been cooled by being used, it can be re-heated to the correct temperature with the least loss of time. Solders, fluxes and methods of heating the iron can be compared and evaluated. The iron may be kept in better condition. When an electric iron is used, a line-voltage regulator may be used to keep the tool at the constant, predetermined temperature.

It is a generally known fact that when two wires of dissimilar metals are connected together at one end and heated, a very low voltage is generated. If the other ends of the two wires are connected to a millivoltmeter a deflection will be obtained.

Although a copper-and-constantan couple does not give the highest E. M. F., it is about the most suitable on the points of reproducibility, low electrical resistance, high resistance to deterioration, and low cost. The temperature/E. M. F. data is given in Table I. In all cases the temperature of the cold end must be subtracted from the temperature indicated.

The millivoltmeter is generally a high-sensitivity, high-resistance instrument having a range of, for example, 25 or 50 millivolts. The scale is figured directly in millivolts. The temperature is read from the table of temperature/E. M. F. figures.

Many electrical instrument manufacturers now make a pyromillivoltmeter, (essentially, a millivoltmeter adjusted for the E. M. F. in mv. at a definite temperature of a given type of couple, with allowance for the resistance of the couple and leads); the scale is calibrated directly in degrees.

Thoroughly clean the two wires for the thermo-couple, twist as shown in Fig. 1A, and hard-solder or silver solder them. Then bend the couple into a circle and flatten it with a hammer. Use No. 18 or 20 B. & S. gauge wire.

Drill and tap for a No. 6-32 screw, as near to the tip as it is possible to place it without having the screw interfere with the work when using the iron; assembly then proceeds as shown in Fig. 1B.

Use thin asbestos paper to insulate the wires from each other and from the iron. A clamping strip made of sheet copper is used to hold the couple firmly against the iron by means of the screw, and the wire leads in place so that they will not break or become damaged.

When heating the iron over a gas burner the flame should not be allowed to play on the couple, as this would result in a false indication and also decrease the life of the couple.

If an electric stove of the type that has a hole in it to slide the iron into is used, the iron may not fit after the couple is installed. In this case it is necessary to "bury" the couple, and possibly the leads. This may be accomplished as shown in Fig. 10. Drill a hole and countersink it to accommodate the screw head, two small washers and the couple loop. Fasten the couple very firmly. Cut a slot from this hole to the back of the iron to hold the leads; insulate these with as-

bestos paper. Place a strap near the back of the iron to hold the leads in the slot.

A thermocouple can be installed on an electric iron, placing it on the soldering tip. The leads should be fastened to the stem and handle by wrapping at intervals with asbestos paper and copper wire. They can be taken off at the end of the handle in the same way the cord is removed from an electric iron.

The benefits derived from this installation in a short time would more than repay any expense or time expended in its installation.

TABLE I

Deg. Fah.	E. M. F. Milliv.
50	1.11
100	2.23
150	3.40
200	4.65
250	5.93
300	7.23
350	8.60
400	9.99
450	11.40
500	12.87
550	14.42
600	16.03

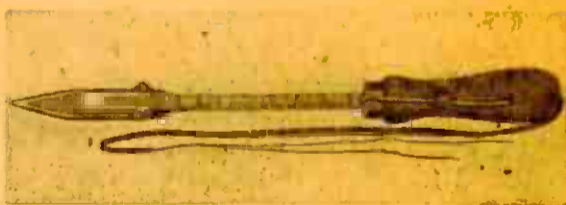

Fig. A. The completed iron.

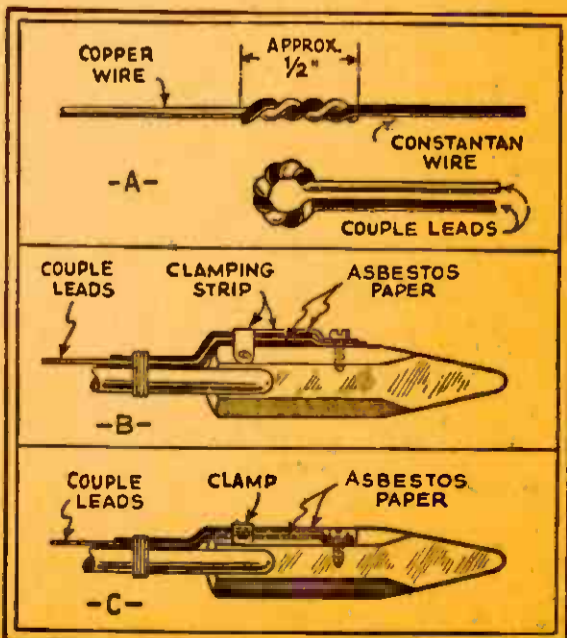

Fig. 1. Testing an iron's heat.

"Potentiometer Shunt" Resistance Tester

By H. HARRISON

This method of resistance testing is incorporated in the writer's article, "A Portable Short-wave Laboratory," which appeared in the October, 1932, issue of the RADIO-CRAFT. The analysis of the theory and design will be of service to those who may desire to build only the resistance test unit.

The usual "series" type of resistance tester, A, Fig. 1, (To cover the range of 25 ohms to 1 meg. would require several batteries, and resistors R.); also, scale-crowding occurs.

The "potentiometer" shunt test system, Fig. 1B, permits a range of 0 to 2 megs.; also, correct selection of resistors eliminates scale-crowding.

To more completely understand the "why" of this device a thorough understanding of its voltage and current distribution is essential. This is illustrated in Fig. 1C and will be analyzed in two separate setups.

Short terminals 13 and 15, and plug in for the desired range: R1, 1 V.; R2, 5 V.; R3, 10 V.; R4, 20 V. Vary potentiometer P for full-scale deflection of meter Ma., and leave the potentiometer in this position; do not vary it as long as any particular range is in use. The unit is now ready.

The potentiometer P can be considered as two resistors in series, A, B, as shown at C, Fig. 1; for a given range these are fixed. If P equals 20,000 ohms the battery current I2, which is constant for all ranges, is 1.125 ma.

Meter Ma., X and R are in series with each other; this combination is in parallel with B. Therefore the meter acts to indicate the voltage across B, or E2.

This voltage is determined by (1), the value of R, and; (2), the adjustment of P to full-scale deflection of the meter Ma. This is the first step. The total current I equals I1 plus I2; voltage E equals E' plus E2.

It will be necessary to find A for any particular range. The formula indicates A equals E' divided by I; and that E' equals E minus E2. In the first step E2 is determined. Assuming the R2 range, E' equals 22.5 minus 5, or 17.5 V. If I equals I2 plus I1, I2 is 1.125 ma.; and I1, from the first step is 1 ma. If I is 2.125 ma., A therefore is 8,250 ohms, for the 5 volt range.

The second step is to test resistor X. Assume current I1 indicated by Ma. is .85-ma. Now, I equals 1.125 plus .85-ma., or 1,975 ma. Hence, E' equals A times I, or 8,250 times 1.975 ma.; E' is 16.262V.; E2 becomes 22.5 minus 16.3 or 6.238 V. Unit X equals E2 divided by I1, minus R2. That is, X equals 6.238, divided by 0.85 times 10-3 or 5,000. Therefore, X equals 7,340 minus 5,000 or 2,340 ohms. And so on for the other resistors.

The same procedure holds for every battery and potentiometer combination.

Table 1 has been computed on the basis of a 22.5 V. battery and a 20,000 ohm potentiometer. Table 2 is for the usual series-type resistance tester or ohmmeter.

TABLE I (Potentiometer Shunt Method)

Ma.	1 V. "X"	5 V. "X"	10 V. "X"	20 V. "X"
.01	1,098,000	1,311,000	1,572,000	2,096,200
.02	547,750	649,000	778,000	1,057,500
.05	211,000	252,000	302,000	402,100
.10	100,000	119,200	140,290	190,600
.15	63,000	75,200	90,000	120,000
.20	44,400	53,000	73,500	64,700
.25	33,300	39,600	56,675	63,650
.30	25,900	30,900	37,150	49,500
.35	20,600	24,600	29,500	39,200
.40	16,650	19,850	23,900	31,250
.45	13,550	16,200	19,700	25,900
.50	11,100	13,225	15,900	21,150
.55	9,600	10,850	13,000	17,225
.60	7,400	8,800	10,600	13,175
.65	5,980	7,125	8,575	11,400
.70	4,760	5,700	6,800	9,100
.75	3,700	4,400	5,375	7,100
.80	2,780	3,310	3,900	5,275
.85	1,960	2,340	2,800	3,700
.90	1,240	1,480	1,750	2,400
.95	585	700	810	1,100
.98	225	280	300	410
.99	20	140	150	100

TABLE 2 (Series Type)

Ma.	22.5 V. "X"	4.5 V. "X"	Ma.	22.5 V. "X"	4.5 V. "X"
.01	2,247,500	445,500	.55	18,400	3,690
.02	1,102,500	220,500	.60	15,000	3,000
.05	427,500	85,500	.65	12,100	2,325
.10	192,500	40,500	.70	9,700	1,940
.15	137,500	29,500	.75	7,500	1,500
.20	90,000	18,000	.80	5,600	1,125
.25	67,500	13,500	.85	4,000	800
.30	55,500	10,500	.90	2,500	500
.35	42,000	8,350	.95	2,200	240
.40	33,750	6,750	.98	450	100
.45	27,500	5,500	.99	250	50
.50	22,500	4,500	R,	22,500	R, 4,500

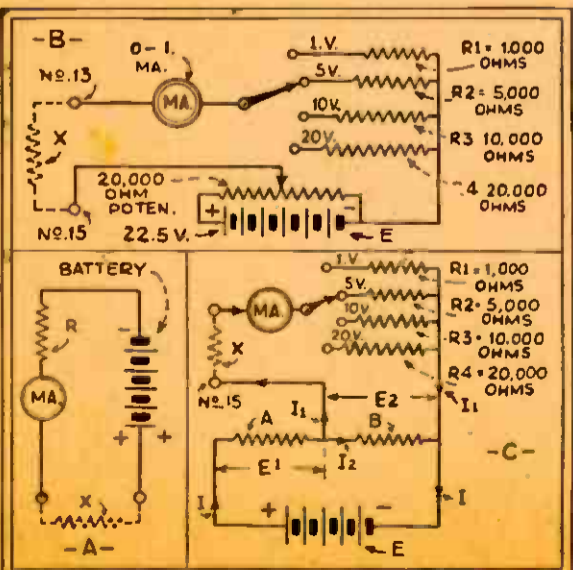

Fig. 1. Ohmmeter circuits.

Library

This is perhaps the first real opportunity that you have ever had to build a radio library of books that are authentic, right-up-to-the-minute and written so that they are easily digested and clearly understood. Mail coupon on the opposite page for your books.

Book No. 10

HOME RECORDING AND ALL ABOUT IT

A Complete Treatise on Instantaneous Recordings, Microphones, Recorders, Amplifiers, Commercial Machines, Servicing, etc.

By GEORGE J. SALIBA

If there is one subject that is fascinating to every radio man, it is that of Home Recording. Of course, this volume is not all on "Home" recording, but the information contained therein is important to commercial radio men, studio operators, engineers and others interested in this phase of radio.

The art of recording and reproducing broadcast selections is becoming more important every day to radio men, experimenters and Service Men. Equipping dance halls, auditoriums, churches, restaurants and homes with public address and amplifiers brings many extra dollars and often an excellent income.

In this book are found such topics as: Short History of the Art; Microphones; Recording Amplifiers; Cutting Heads; Types of Records; Commercial Machines; Adding Records to Receivers; Studio Layouts; Mechanical Filters for Turntables.

BIG DISCOUNT OFFERED

In order to make it possible for everyone to buy these books, the fifty (50) cents price has been made uniform for all volumes. You can buy these books separately, but you should take advantage of our special offer:

When Five (5) Books or More Are Ordered Deduct 20% from Your Remittance

Simply fill in the coupon below, and mail it to us together with your remittance. Checks, stamps or money orders accepted.

All Books Uniform

The books in the new RADIO-CRAFT LIBRARY are all strictly up-to-date, and written by men who know their subjects.

The volumes are all uniform size, 6 x 9 inches, and contain on an average of 50 to 120 illustrations. Each book is printed on fine book paper, and no expense has been spared to make it an outstanding value for its editorial contents as well as from the mechanical standpoint.



OPERATING NOTES

(Continued from page 284)

quite a substantial profit by revamping them in accordance with the circuit at B, in Fig. 5. The procedure is simple: The "antenna clarifier" is done away with, and a "tone control" is substituted in its place. The volume control, R, which fortunately has a value of 10,000 ohms, is shunted across the antenna and ground, and the center arm connected to the control-grid of the first tube, thus making that tube an untuned input unit. This system greatly increases the volume and eliminates one tuning control. We have remodeled quite a number of these sets in this manner and the owners have been more than satisfied with the results.

VELOCITY MICROPHONE

(Continued from page 299)

Convenience

The Velocity Microphone does not require a built-in or closely linked amplifier. Its output may be fed to an amplifier located several hundred feet away in the control room. Moreover, mixing of the outputs of several of these microphones is entirely practical. Such a low-level switching arrangement reduces the number of amplifiers required with consequent economies in speech input cost.

Since it requires no field or polarizing supply, the connections from microphone to control room are extremely simple—only a two-wire cable being required. The unit itself is relatively light. It may be quickly and easily removed from the stand and carried to another position. As the unit has mounted on it a receptacle into which the cable plug fits, it is unnecessary to drag the cable around with the unit.

LOOP ADAPTER

(Continued from page 302)

- Four Aerovox 1, mf. bypass condensers, type 261, C4, C5, C6, C7;
- Two Kenyon 300 henry audio chokes, type BC-3000—C113, C114;
- One Centralab 500-ohm potentiometer, P;
- One Kenyon power transformer, type B-4311—PT—T;
- One Weston galvanometer, zero center, type 30-0-30 milliamperes;
- One Blau set of special aluminum shields;
- Five binding posts;
- Necessary wire, screws, etc.

The parts for the hum filter, if needed, consist of the following:

- One Kenyon 300 henry audio choke—type BC-3000;
- One Aerovox .00005-mf. fixed condenser.

SET ANALYZER

(Continued from page 308)

characteristics of these tubes, as indicated on a table of tube characteristics, and comparing these figures with the values indicated on the meters in the set analyzer; this will be true whether these figures are obtained directly, or through the use of special adapters designed to accommodate to the analyzer the particular connections of the tube under test. *Technical Editor.*

Now that we have covered the connection of meters to fundamental circuits,—just as the modern set analyzer connects them—the author will proceed to describe, in a forthcoming issue of RADIO-CRAFT, the quickest and most efficient manner of operating this up-to-date test instrument.

ANALYZER ADAPTER

(Continued from page 304)

- One five-prong tube base;
- One six-prong tube base;
- Three screen-grid cups;
- One box, about 7 x 6 x 1 inch;
- One panel, about 7 x 6 inches;
- One International Air plug extension No. 95, seven connections;
- Seven pair Yaxley insulated tip jacks, Nos. 1 to 14;
- Six toggle switches, D, E, F, G, H, I;
- One four-prong tube socket, A;
- One five-prong tube socket, B;
- One six-prong tube socket, C.

SAY!

If you service men haven't got around to handling Amplifiers and making Amplifier installations, you are passing up easy money! Take, for instance, your 50-year-old friend, the SAMSON ELECTRIC COMPANY, and its PAM-110, the marvel of all Class B Amplifiers. Here is the lowest priced unit judged by the amount of power (26 watts) per dollar cost.

Yes, sir, SAMSON has given you a fast one in the PAM-110—for 110 volt current, 50-60 cycles, with variable output impedance for voice coil, to line or to magnetic speakers and designed for operation with the SAMSON MIK-110 . . . a combined input mixer, input coupling device, and tone modifier.

Here's a chance to add to your line profit-making items which are gaining widespread attention.

SPECIAL OFFER: Our Bulletin RC1 covers the theoretical and practical uses of Class B Amplification and the complete story of the PAM-110 and the MIK-110. Send stamps, totaling 15c to cover the cost, and address:

R. W. COTTON

Samson Electric Co., Canton, Mass.
Member R.M.A. Mfrs. Since 1882

The New

SHALLCROSS

General Purpose Meter
No. 610

provides facilities for a wide range of electrical measurements not usually possible in one instrument. Employing a No. 610 Shallcross Resistor Kit and the Weston Model 301 Universal Meter, this combination meter measures:

- 4 D.C. Voltage Ranges
- 4 D.C. Current Ranges
- 4 A.C. Voltage Ranges
- 4 A.C. Current Ranges
- Resistance Measurements of 1 ohm to 3 megohms
- Inductance measurements, 1 to 10,000 henrys
- Capacity measurements, .001 to 10 mfd.
- Output Meter

Send 6c in stamps for Bulletin 152-P which contains a diagram of this circuit and information on its construction.

Shallcross Mfg. Company
ELECTRICAL SPECIALTIES
700 PARKER AVENUE
Collingdale, Pa.

HEADQUARTERS
FOR MATERIALS
AND PARTS
FOR BUILDING
Electrical and Radio
**TREASURE
LOCATORS**

Radio, Audio, Ground Potential measurements, Hughes Induction Balances and other types; Oscillators and amplifying systems included.

We supply all materials needed for building and operating any of the recognized treasure finders.

The following standard circuits are described in our bulletin:

Mail Coupon TODAY!

GREN PARK COMPANY Dept. RC-11
245 Greenwich St., New York, N. Y.

Enclosed find 10c for which kindly send me pamphlet on Treasure Finders.

Name

Address

City and State



- No. 1. Ground Potential, Leap-Frog Method.
- No. 2. Hughes Induction Balance Type A
- No. 3. Hughes Induction Balance Type B
- No. 4. Sensitive Hughes Induction Balance
- No. 5. Simple Super-Sensitive Hughes Balance Circuit
- No. 6. Radio Frequency Oscillator Circuit
- No. 7. Audio Oscillator Circuit
- No. 8. Single Search Coil Hughes Induction Balance with Audio Amplifiers
- No. 9. Combination Radio Transmitter and Receiver circuit.

Also accessories such as High Frequency Buzzers, Audio Oscillators, Differential Current Transformers, Two Stage Audio Amplifiers, etc.

With all this apparatus you can locate buried treasures, metal war relics, mineral deposits, subterranean water veins, buried gas and water pipes, and lost objects, tools and treasures sunken in water, etc.

Write for pamphlet giving history and theory on this interesting subject. All above circuits are described and explained. List of parts and prices included. (Price of pamphlet 10c.)

**SERVICING MODERN
SUPERHETERODYNES**

WE are in receipt of the following additional data concerning the article entitled "Servicing Modern Supers," which appeared in the May 1932 issue of RADIO-CRAFT, page 670. In interpreting the data appended below, refer all figure references to the article referred to above.

**Adjusting the Zenith Model 103,
14-Tube "Hyperheterodyne"**

In spite of the fact that this receiver possesses a plurality of tuned circuits, its adjustment presents no difficulties to the Service Man equipped with a good service oscillator. The circuit of another superheterodyne of particular interest to the Service Man is that of the Zenith model 103 receiver; reference should be made to this diagram, which was published in the March, 1932 issue of RADIO-CRAFT, page 61.

In re-aligning this receiver, it is possible to use the oscillator without an output meter, since the tuning meter on the set is connected to show variations during all adjustments of R.F. and I.F. circuits; the greatest swing to the right representing maximum output. However, if the output meter is available with the oscillator, this should be used, since it is more accurate.

The six tuned I.F. circuits are adjusted as follows: Remove the clip from the control-grid of the first-detector; and then connect the service oscillator to the control grid cap of the first-detector (through a .00025-mf. condenser), and to the chassis. The set oscillator tube is to be removed for this test. The first-detector plate screw, which will require adjustment, is the one furthest to the left when viewing the chassis from underneath (with the control shafts at the top); this is the adjuster of condenser C5.

The Hyperheterodyne is easily adjusted for ordinary 10 kc. selectivity in the I.F. circuit; or for 5 kc. band-pass, if exceptional selectivity is desired to reduce or eliminate whistles due to two stations heterodyning.

The first inductance (primary of L5) is tuned for maximum deflection of the output meter at 175 kc.; the secondary is also tuned to 175 kc.

Next, the primary of L6 is tuned to 170 kc. when 10 kc. in band-pass is desired, or to 172.5 kc. if 5 kc. band-pass is wanted. The secondary is next tuned to 180 kc. for 10 kc. band-pass, or to 177.5 kc. if 5 kc. is desired.

The balancing of L7 is exactly the same for both primary and secondary as L6.

This procedure completes the I.F. adjustments for 10 kc. or 5 kc. band-pass, as desired. The I.F. amplifier may be balanced at 7 1/2 kc. in cases where the decrements or resistances of the tuned circuits are such that they are naturally broad. The service oscillator connections are removed from tube V3 and normal connections are restored.

Next, the set's R.F. and oscillator tuned circuits are adjusted. The service oscillator is connected across aerial and ground of the receiver, and is to be adjusted to 550 kc. The high-frequency trimmer condensers for the input band-selector, the R.F. secondary, and the first-detector secondary, are now tuned for maximum deflection on the output meter. The set oscillator high-frequency trimmer is next adjusted for maximum indication. It may be necessary to change the adjustment of the other trimmers in order that the signal from the service oscillator may be observed (or heard in headphones).

To effect the concluding adjustment of the oscillator section, it is necessary that the low-frequency padding condenser C8 be adjusted for the greatest swing of the meter while rocking the dial back and forth "across the signal." The service oscillator is still tuned to 550, the same as when the high-frequency trimmers are being resonated at the low-frequency end of the tuning scale.

These steps are followed not only with the Zenith model 103, but also with any other superheterodyne of the same general design.

In adjusting superheterodynes having a special oscillator-condenser designed to track 175 kc. above the antenna signal without the use

(Continued on page 314)

HERE IT IS!

HOW TO BECOME AN

AMATEUR RADIO OPERATOR

We commissioned Lieut. Myron P. Eddy, U. S. Navy, Retired, to write a book on this subject that would answer EVERY possible question in such a way as has never been done before. We chose Lieut. Eddy because his long years of experience in the amateur field have made him pre-eminent in this line. For many years he was instructor of radio telegraphy at the R.C.A. Institutes, and in this capacity he obtained a vast knowledge and insight on the subject. He is a member of the I.R.E. (Institute of Radio Engineers), also the Veteran Wireless Operators' Association. If you intend to become a licensed code operator, if you wish to take up phone work eventually, if you wish to prepare yourself for this important subject—this is the book you must get. This book covers literally everything from "soup to nuts" on the subject, in such a clear and lucid manner that it will be of great value to every student.

50c THE COPY

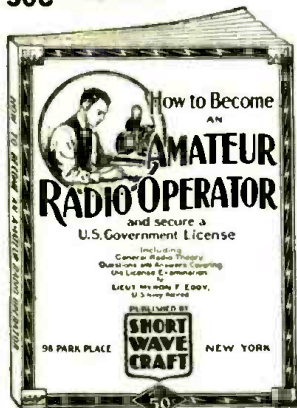

72
Pages
Over 150
Illustrations
Not
Sold
on
News-
stands

Partial List of Contents

CHAPTER 1. Ways and means of learning the code. A system of sending and receiving with necessary drill words is supplied so that you may go right to work on approved methods.

CHAPTER 2. Concise, authoritative definitions of radio terms, units and laws, brief descriptions of commonly used pieces of radio equipment. This chapter gives the working terminology of the radio operator. All graphic symbols used to indicate the various parts of radio circuits are shown so that they may be readily recognized when studied in the following chapters.

CHAPTER 3. General radio theory particularly as it applies to the beginner. The electron theory is briefly given, then waves—their creation, propagation and reception. Fundamental laws of electric circuits, particularly those used in radio, are explained next and typical basic circuits are analyzed.

CHAPTER 4. Descriptions of modern receivers that are being used with success by amateurs. You are told how to build and operate these sets, and how they work.

CHAPTER 5. Amateur transmitters. Diagrams with specifications are furnished so construction is made easy.

CHAPTER 6. Power equipment that may be used with transmitters and receivers, rectifiers, filters, batteries, etc.

CHAPTER 7. Regulations that apply to amateur operators.

CHAPTER 8. Appendix, which contains the international "Q" signals, conversion tables for reference purposes, etc.

Aero International All Wave II Tube Super-Hetrodyne *DeLuxe*

15 to 550 METERS \$29.75

The greatest radio value ever offered. Explore the world with the Aero International. At last! World Wide Loud Speaker Reception at a Sane Price. One-dial control. No plug-in coils. Designed so any novice can get maximum results on both short and broadcast bands. This is not a converter and broadcast chassis. It is one receiver covering all wave lengths. 2 Sets in 1. Besides your regular broadcast band, also receives Foreign Programs, Amateurs, Police, Ships at Sea and Aeroplanes. Employs the latest type Super-Phonic Tubes. Completely assembled with 2 matched full Dynamic Speakers (less tubes) . . \$29.75

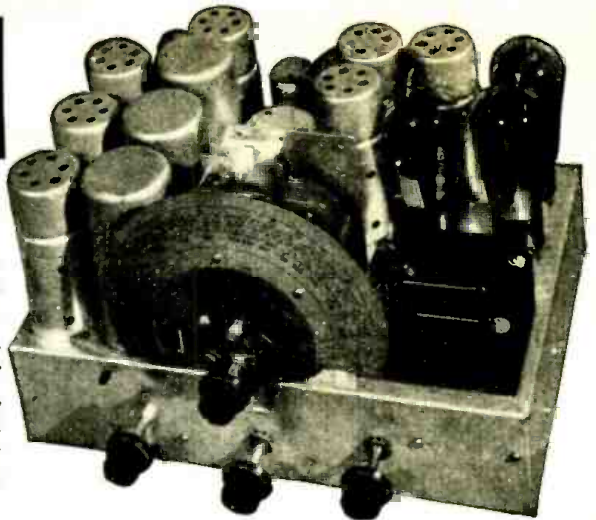

AERO 4 TUBE

The lowest priced quality Midget Receiver on the market today.

PRICE \$10.95
(Less tubes)

Complete set of the New Super-Phonic Tubes \$2.95

This wonderful distance getter is equal in performance to last season's 5 Tube Pentode Sets.



AERO 6 TUBE

Super - Heterodyne Automatic Volume Control

Price of Set \$18.50
(Less tubes)

Complete set of Tubes \$4.50

Split Hair Selectivity, Phono Jack, Guaranteed Coast-to-Coast Reception. Seven Tuned Circuits. Composite First Detector and Oscillator followed by 2 stages of 175 D.C. Intermediate.



AERO 5 TUBE

Employs the latest type Super - Phonic Tubes. Guaranteed Coast-to-Coast Reception. Split Hair Selectivity Phonograph Pick-up connection. Single illuminated Full Vision Traveling Spot Light Dial. Mellow Toned Full Dynamic Speaker.

Price \$11.90
Tubes . . . \$3.75

AERO PENTODE AUTO RADIO SUPER-HETERODYNE



6 TUBE SET
New 1933 Model. Automatic Volume Control. Employs

the latest Super-Phonic tubes. At last! The perfect Auto Radio. Take your favorite stations with you while you travel along.

Price of set with Matched Dynamic Speaker and Remote Control (less tubes) . . . \$19.75

Price Complete with all accessories, ready to install . . . \$31.90

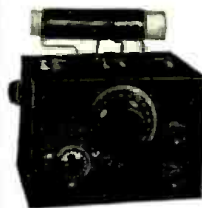

AERO World - Wide 1-Tube Short Wave Set

For Headphone Operation
PRICE \$5.95

Listen in DIRECT to London, Paris, Berlin, Buenos Aires and other broadcasting stations throughout the world via short waves. Your ordinary receiver cannot tune in these low wave stations. WORLD-WIDE RECEIVER gets 14 to 550 meters. AERO 2 Tube Short Wave Set \$8.75. The same as above set but has 1 stage of Audio Frequency added to it.

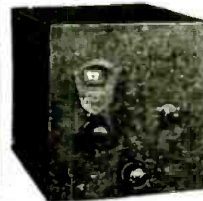

AERO SHORT WAVE SUPER- HETERODYNE CONVERTER

Convert your A.C. Radio Set into a Short Wave Super-Heterodyne. 15 to 550 Meters.

PRICE \$12.50

AERO PENTODE POWER AMPLIFIER

PRICE \$9.85

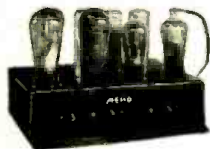

Employing the New Super-Phonic tubes. Designed to supply the need for a rea-

sonable priced amplifier for sound trucks and public address systems.

AERO BATTERY SUPER-HETERODYNE 6 TUBE SET

Employing Latest Air Cell Tubes. Price in Midget Cabinet with Electro Magnetic Speaker . . . \$14.50

Send for Catalog of Sets and Parts

AERO B ELIMINATOR

180-volt Bone dry. Supplies B current for sets using up to 9 tubes.

PRICE including 280 tube \$6.75

AERO A.B.C. AC POWER PACKS

For Sets Using Up to 12 Tubes

Type No. 10—Supplies filament and B power to six 227 or six 224 tubes. Also six 235 tubes and two 247 or 245 tubes.

PRICE \$9.75

Type No. 12—For sets using up to 9 tubes, using 226, 227, 271 and 280 tubes.

PRICE \$8.75

CHAS. HOODWIN CO.

4240 LINCOLN AVE.

Dept. Y-15

CHICAGO, ILLINOIS

3 New 50c Books



No. 1. FORMULAS AND RECIPES For the Practical Man By S. GERNSBACK

An extremely helpful book showing you how to save money by making in your own home, at a fraction of the regular cost, the hundred and one preparations which you now buy for use at home or business.

PARTIAL CONTENTS:

1. Adhesives; Glues, Cements. 2. Cleansing; Stain Removers, Bleaches. 3. Metal Craft; Coloring, Oxidizing, Plating, Polishes. 4. Paints; Colors, Stains, Varnishes. 5. Glass-Working; Cutting, Drilling, Boring, Etching, Engraving. 6. Wood-Craft; Finishing, Acid-proofing, Waterproofing, Furniture Polishes. 7. Inks; Sympathetic, Invisible, Hectograph. 8. Photography; Developers, Emulsions, Fixers. 9. Antidotes for Poisons, Remedies for Burns and Scalds, Disinfectants. 10. Preparation, Manipulation, Handling, Mixing, Tables of Weights and Measures, Useful Tables.

No. 2. FUNDAMENTAL PRINCIPLES OF RADIO Radio Simply Explained—Its Origin, Nature and Functions

By LOUIS MARTIN



Prepared with special consideration given to young members in the radio profession, and those who have gained their experience in a haphazard fashion. This radio primer is a handy fundamental aid for "checking up" and systematizing your knowledge of radio. Regardless of how much you know about the subject, you should read this book.

PARTIAL CONTENTS:

Chapter I—Fundamentals of Radio: Electricity, Resistance, Batteries, The Magnetic Circuit, The Magnetic Field, Inductance, Condensers, A.C. Circuits, Propagation of Radio Waves; Chapter II—The Simple Radio Set, Single, Two, and Three-Circuit Tuners, The Battery Set, Vacuum Tubes, Electric Sets, Loud Speakers; Chapter III—Diagrams, How to Read Them; Chapter IV—Amateurs and Broadcast Stations, Talking Pictures, Television.

No. 3. ELEMENTARY MATHEMATICS for the Technician and Craftsman By C. SHAINMARK

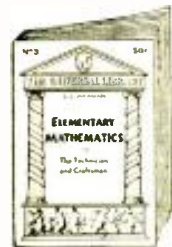

This manual has been especially prepared for the man who wishes to acquire a working knowledge of the elementary principles of mathematics. A complete treatment of the subject is given by the author, Mr. C. Shainmark, with special attention to the use of mathematics in Radio and other technical work for those who employ its formulas daily.

PARTIAL CONTENTS:

I—Arithmetic: Addition, Multiplication, Subtraction, Division, How to Use Decimals; II—Fractions, Percentages, Ratio and Proportions; III—Powers and Roots; IV—The Metric System; V—How to Measure Surfaces and Volumes; VI—Mathematics for the Manual and Technical Craftsman; VII—Special Mathematics for the Radio Technician; VIII—Commercial Calculations, Short-cut Arithmetic, Interest Calculation, Discounts; IX—Weights and Measures; X—Useful Tables.

All our books are of uniform size, 6 x 9 inches, and contain 64 pages. The books are printed on strong paper with stiff colored covers.

ROSS GUILD INC., 16 Murray St., New York City. RC-11
Enclosed find \$.....for which mail me postpaid the following books:

No. 1 No. 2 No. 3
50c each, Postpaid.

Name
Address
City and State.....

SERVICING SUPERS

(Continued from page 312)

of a padding condenser, the R.F. section is tuned to maximum deflection after the condenser has been adjusted to the number of dial degrees for the particular antenna signal, which in this case is generated by the oscillator. After the R.F. sections have been adjusted, it is then only necessary to adjust the trimming condenser of the oscillator to maximum swing on the output meter.

MEASURING SMALL RESISTORS

Mr. S. H. Burns, in the February issue of this magazine described a "Resistance Calculator." Additional information is given below. An additional panel layout is shown in the sketch below.

To measure resistors that are less than 1000 ohms, the switch is opened, cutting the 2500 ohms into the measured circuit. With the unknown resistance connected to terminals 3 and 4, set the voltage at 10 volts. Assuming that the current indicated by the milliammeter is 3.7 ma., it will be found that this corresponds to 2700 ohms. Now deducting the 2500 ohms, the actual resistance is 200 ohms.

On a 0-10 ma. scale, tenths are easily and fairly accurately ascertained, especially when the divisions represent one-half ma. After the device has been used once or twice, the time consumed in measuring a resistance is almost "nil." Where a tap or several taps are to be placed upon a wire-wound resistance strip, this device is particularly useful. It is always good practice when doing this to check the over-all resistance after each tap has been measured.

To enable the experimenter to check plate-coupling resistors, the curve has been extended to the 25,000-ohm value. This portion of the curve is dotted. From 10,000 ohms up, each horizontal division or line indicates 500 ohms. Also, it must be used with a voltage of 100 to give a reading on the milliammeter so that actually the 10,000 line means that the resistance is 100,000 ohms. These are the reasons for dotting this line. Plate resistance up to 50,000 ohms can be checked within the allowable limits of accuracy.

A Mounting Panel

The experimenter may find this device so useful that he will want to have it intact and available for use at a moment's notice. A suggested panel layout is given in Fig. 4. The parts to be mounted underneath are outlined by dotted lines.

This panel can be made of 1/4-in. bakelite or plywood and a shallow box made of the same material will protect the parts from injury or short circuit. The two binding posts, 1 and 2, are terminals for the 110-volt input and the terminals 3 and 4 are used for connecting the unknown resistance. For convenience, these two can be replaced with short leads terminating in a snap clip. This is more convenient in making contact with the ends of resistors. Also, at times it may be convenient to measure some resistor in its place in the set. These leads will make it possible to do this.

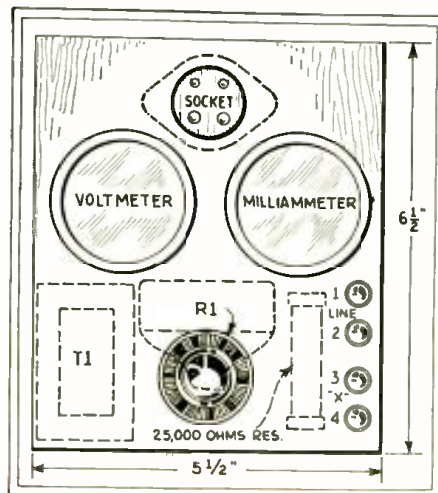

CLASSIFIED ADVERTISEMENTS

CHEMISTRY

BECOME A TRAINED CHEMIST. Thousands of opportunities—fascinating career. Learn at home. Complete experimental laboratory outfit given. Write for big free book. Chemical Institute, 19 Park Place, Dept. RC, New York.

INVENTORS

PATENT YOUR INVENTION: Send for FREE book "How to Obtain a Patent," and "Record of Invention" Blank. Ask us about how to protect your ideas. Deferred payment. Victor J. Evans & Co., 6201 Victor Bldg., Washington, D. C.

MISCELLANEOUS

WESTINGHOUSE oil tank static condensers. Maximum operating voltage 2300, 60 cycle. \$4.75 each. Maynard Miller, 938 North Homan Avenue, Chicago, Illinois.

RADIO

GUARANTEED MICROPHONE REPAIRS—Any make or model—24 hour service. Stretched diaphragm double button repairs, \$7.50. Others, \$3.00. Single button repairs, \$1.50. Write for 1933 Catalog with diagrams. Universal Microphone Co., Ltd., Inglewood, Calif.

TRANSFORMERS REWOUND, varnished, baked, guaranteed, reasonable cost. SPEAKER REPAIRING, magnetic \$2.00-\$2.50; dynamic, voice coils, fields, etc., reasonable charges. Clark Bros. Radio Co., Albia, Iowa.

RADIO Service Men Attention—Power transformers, rewound or rebuilt, to your requirements. Meyke Radio Service, 2624 Margaretta, Maplewood, Mo.

WANTED—Cheap, slightly used Hickok analyzer. Write, G. Shuey, Talmage, Kansas.

S. GERNSBACK'S RADIO ENCYCLOPEDIA

2nd EDITION

This New Second Edition gives you an explanation of every word used in radio

2,201 RADIO DEFINITIONS
1,253 TECHNICAL ILLUSTRATIONS
34 TABLES AND CHARTS
24 PAGES OF APPENDIX
Red Morocco-Keratol Flexible Binding
Printed on strong ledger paper, Loose-Leaf Arrangement

352 pages
9 x 12 inches
Weight 3 lbs.



\$3.98

S. GERNSBACK CORPORATION,
98 Park Place, New York, N. Y.

Send me one copy of the new Second Edition S. Gernsback's Radio Encyclopedia. I enclose herewith \$3.98, check or money order, preferred. (Foreign and Canada, add 35c extra for postage.) Money refunded in full if not satisfactory.

Name
Address
City..... State.....
RC-11-32

Powertone Push-Pull Direct Coupled Amplifiers

For use with any receiver (detector plate lead clips to input post on this amplifier) can be used as a phonograph amplifier or with any suitable microphone arrangement. Will operate one or more dynamic speakers. External field current is required to operate. Volume is exceptionally great, no distortion at all. Three-position toggle switch enables proper line voltage adjustments. Compact and durably constructed. For operation on 110-120 volts A.C., 50-60 cycles. Shipping weight, 30 lbs. Regular list price, \$100.00.



P.P. Model 245 uses 1—224, 2—245's and 1—280.
No. RC 251—Our Price \$16.95 (less tubes)
P.P. Model 247 uses 1—224, 2—247's and 1—280.
No. RC 252—Our Price \$17.95 (less tubes)

OXFORD DYNAMIC SPEAKER CHASSIS



Oxford Speakers are constructed to give reproduction as near perfect as possible—they have long been known to give radio's finest tone qualities. The most advanced principles of speaker design for dynamics have been incorporated in Oxford Speakers. Those that bear recognition are: the three-point suspension balance; permanentized controlled diaphragm; moisture-proof coil mountings; and inertia counteracted construction.

A.C. Models—14" Auditorium Speaker, using 280 rectifier, No. RC 177—\$10.00
12" Concert Dynamic, using 280 rectifier, No. RC 178— 8.50
9" Midget Dynamic, using 280 rectifier, No. RC 179— 7.50
D.C. Models — 14" Speaker, 5000 ohm field, No. RC 180— 8.95
11" Speaker, 2500 ohm field, No. RC 181— 4.95
9" Speaker, 2500 ohm field, No. RC 181— 2.45
All 9" Midgets are supplied with hum balancer.

BALDWIN DYNAMIC CHASSIS

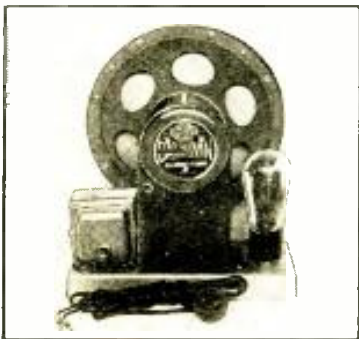

The introduction of the BALDWIN name need not be further discussed.

From the beginning of Radio, Baldwin has been a pioneer in radio reproducing equipment. We need no further praise in recommending a Baldwin Speaker for any purpose in regard to radio.

A.C. using 280 Tube Rect., No. RC 410—Our Price \$6.95
D.C. 2500 Ohm—110 Volts, No. RC 411—Our Price \$4.95
D.C. 2500 Ohm—110 Volts Field, Less Stand, No. RC 412—Our Price \$4.00
D.C. 2500 Ohm—110 Volts Field, Less Output Trans., No. RC 413—Our Price \$3.25

POWERTONE DIRECT COUPLED AMPLIFIERS



All the latest features in amplifier design have been incorporated in this direct coupled amplifier. Input terminals for permitting phonograph attachment, and in addition, by attaching the proper microphone transformer, also dry cell batteries, a microphone may be used for public address work. Any type of receiver can be connected to the input terminals without fear of loss of energy. These amplifiers are for use with dynamic speakers.

Amplifiers supply field current of 2500 ohms to dynamic speakers. Resistors are furnished when D.C. speakers are used. Amplifiers operate on 110 volts, A.C., 60 cycles.

Model RC 245 uses 1—224, 1—245 and 1—280
Output is rated at 3 watts.

No. RC 245—Our Price \$10.95 (less tubes)
Exactly the same amplifier, but employs a power pentode in place of the 245 tube. Output is rated at 2.5 watts.

No. RC 246—Our Price \$12.95 (less tubes)
Model RC 250 uses 1—224, 1—250 and 1—281.
Consumption is 85 watts; maximum undistorted output, 6 watts. Gain rated at 100 cycles, 55db; gain at 1000 cycles, 52.5 db; gain at 10,000 cycles, 51.5. Input direct to 224 control grid; output direct from 250 plate.
No. RC 250—Our Price \$15.25 (less tubes)

R.C.A. VICTOR HAND MICROPHONE



This microphone is furnished with the latest model Radiola 86 Home recording Super-Heterodyne Receiver and Amplifier. Do not confuse this microphone with the "toy" type as it can be used for many professional and commercial uses. It is a single button "mike" with a gun metal finish. Its total length is 6 1/2" and has as standard equipment a four foot cord.

No. RC 417—Our Price \$2.75

Franklin Transmitting Keys and Buzzers Practice Set



For those who want to practice code, sending and receiving, this small practice set is recommended. A small dry cell is required to operate buzzer, otherwise it is complete.

No. RC 300—Key only, 95c
No. RC 301—Buzzer only, 69c

JENSEN DYNAMIC SPEAKER CHASSIS

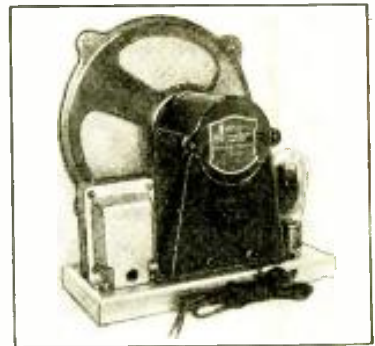

The tone and quality of these reproducers are unsurpassed. Will reproduce faithfully under the most trying conditions. These speaker outputs are available for all new type tubes as well as the old.

A.C. Types, D-7 Jr. Auditorium (as pictured) uses 280 rectifying tube in conjunction with 8 mfd. electrolytic condenser which insures minimum hum.

JENSEN—
A-7—1.8 Dry Rectifier.....No. R 184—\$14.95
A-7—D-7 Jr. Audit. Tube Rectifier.....No. R 185— 9.95
A-7—D-15 Concert Jr. Tube Rect.....No. R 186— 7.50
D-9—2500 Ohm D.C. Field.....No. R 187— 6.95
D-7—2500 Ohm D.C. Field.....No. R 188— 7.50
D-15—Midget, 2500 Ohms.....No. R 189— 4.75

FARRAND INDUCTOR DYNAMICS

Farrand Inductor dynamic, the finest speaker available anywhere for A.C., D.C., or battery operated sets.

Will take as much power and reproduce in tone and quality as the finest dynamic speaker will.

In buying a FARRAND INDUCTOR DYNAMIC you are making a safe investment, because these speakers will match any of the new output tubes as well as all the old type output tubes.

A special feature of the FARRAND INDUCTOR DYNAMIC is that it has a freefloating cone, which tends to bring forth the speech and music with true fidelity. Absolutely will not blast or rattle.

Please state type of power or power tubes when ordering.
9 inch model.....No. RC 192—\$5.95
12 inch model.....No. RC 193— 5.95



T.C.A. "OVER-SIZE" INPUT PUSH-PULL AUDIO TRANSFORMER

Enclosed in a fully shielded, highly attractive cadmium plated steel case. Ideal for sub-panel structure mounting, by virtue of the protruding solder lug terminals—by employing mounting collars, this unit can also be used for "bread-board" style installation.

A master unit—measuring 3 1/2 inches x 2 1/2 inches x 3 inches tall. Actually weighs 2 1/2 pounds!

Windings are rendered impervious to moisture. This unit can also be used as an excellent conventional all-stage A.F. transformer.

We highly recommend the use of this highly efficient transformer in public address amplifiers as well as for GENERAL REPLACEMENT PURPOSES!

No. RC 900—Our Price—\$1.35

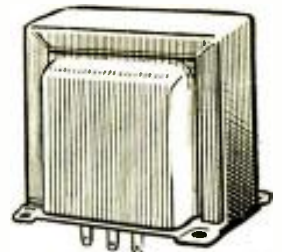

All offers are F.O.B. New York, and subject to prior sale. Terms: A deposit of 20% is required with every order. Balance may be paid on delivery. Or, deduct 2% if full amount is sent with order. Mention catalog number when ordering.

GRENPARK CO., Dept. RC., 245 GREENWICH STREET, NEW YORK, N. Y.

SEND NO MONEY--

Clip and mail to us coupon below. We will send you either one or both books through the Express Company for your inspection. You have the privilege of keeping or returning them.

If you want to have a complete set of all Radio Diagrams, both manuals should be in your file.



Volume I, 1931 Edition

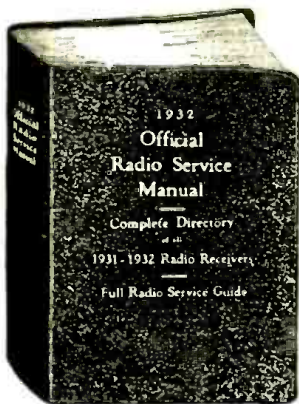

Volume II, 1932 Edition

Both volumes of the OFFICIAL RADIO SERVICE MANUAL will give you the most complete set of circuit diagrams ever published for the Radio Industry. Every Radio Service Man and Dealer should have them available for immediate use in his business. Professional set-builders and amateurs will find them instructive and helpful.

Briefly outlined below are the "high spots" that are to be found in the 1931 Manual—the first complete radio service manual ever to be published. Over twenty-seven thousand copies of this edition were sold to members of the radio industry. This assures you of its importance to those engaged in radio and how valuable it is to them.

Partial Contents

Wiring diagrams of radio sets manufactured since 1927, and many earlier ones of which there is any record elsewhere.

650 pages of radio-servicing material. Complete course of instruction for Radio Service Men, dealers, manufacturers, jobbers, set builders and amateurs.

(Here are but a few of the subjects covered in the special course of instruction).

Amplifiers	Power-Supply Systems
Antennae	Radio Phonograph
Automotive Radio	Equipment
Condensers	Resistors
Detectors	Short-Wave Sets
Eliminators	Speakers
Meters	Tubes

\$4.50 Complete with Supplements

650 PAGES

(Complete with Supplements)

Over 1,500 Diagrams, Charts and Illustrations

Get Supplements FREE with the NEW 1932 MANUAL

There is so much new material in this Manual, that a Service Man or dealer would be lost without it when called to service a set. Information about new models which have been on the market only a few weeks are contained in this book. The 1932 Manual makes the service kit complete.

The 1932 Manual contains a Full Radio Service Guide and a Complete Directory of all 1931-1932 Radio Diagrams, also models of older design. Everyone in the Radio business should have a copy. Send for yours today!

Partial Contents of Volume II

A step-by-step analysis in servicing a receiver which embodies in its design every possible combination of modern radio practice; it is fully illustrated and thoroughly explained. It is the greatest contribution to the radio service field.

Chart showing the operation of all types of vacuum tubes, whether new, old or obsolete. An exclusive resume of the uses of the Pentode and Variable-Mu Tubes and their characteristics.

Complete discussion of the superheterodyne and its inherent peculiarities. Also a special chapter on tools used on superheterodyne circuits. Schematic diagrams and circuits complete with color codings.

Important chapters on commercial aircraft radio equipment; new data on commercial short-wave receivers and converters.

Servicing and installation of public address systems and talking machine equipment.

Standardized color-codings for resistors.

Operation of old and new testing equipment; tube voltmeters, output meters, oscillators and aligning tools.

A full section on Midget radios—their design, circuits, and types. How to service them most economically.

Hundreds of schematic diagrams of older radio receivers which have never been published.

Blank pages for recording notes, diagrams and sketches; these pages are transferable to any part of the book.

Coupon page for free questions and answers.

\$5.00 Complete with Supplements

OVER 1,000 PAGES

(Including Supplements)

Over 2,000 Diagrams, Charts and Illustrations

Flexible, Looseleaf Binder, 9 x 12 inches.

CLIP COUPON AND MAIL TODAY!

GERNSBACK PUBLICATIONS, Inc.
96-98 Park Place, New York, N. Y.

10C-11

Please send me for FREE inspection, the books I have checked below. I understand I may examine them carefully, and should I decide to keep them, I will pay the full cost, plus the few cents for carrying charges. This offer is good only in the U.S.A.

Volume I, 1931 Manual, with Supplement, \$4.50.

Volume II, 1932 Manual, with Supplements to be mailed Free every 60 days, \$5.00

BOTH BOOKS FOR \$9.00.

Name

Address

City State

Flexible

Looseleaf

Binder,

9 x 12 inches.

NOT ONE OF THE DIAGRAMS PUBLISHED IN VOLUME NUMBER I OF THE OFFICIAL RADIO SERVICE MANUAL IS REPEATED IN VOLUME NUMBER II.

JUST OFF THE PRESS!

Free

RADIO'S MOST COMPLETE CATALOG - 1933 EDITION



The latest, greatest edition of radio's bargain book, featuring radios newest developments, is here. 1933 Lafayette receivers, Trutest parts, Tubes, Speakers, Kits, Accessories, Short Wave Sets and Apparatus, Amplifiers, Public Address Systems and Replacements Parts. Everything brand new . . . at the lowest wholesale prices in all our history.

RADIO SERVICE MEN. Wholesale Radio Service Co. carries a tremendous stock of replacement parts for all sets. What you need when you

need it . . . at wholesale prices. Buy with confidence and safety from the largest institution of its kind in the world.

Write for a free copy of our new 1933 catalog today and bring the world's largest radio selection to your home.

Mail Coupon in lower right hand corner of this page.

LAFAYETTE DUAL WAVE CHASSIS 15-550 METERS

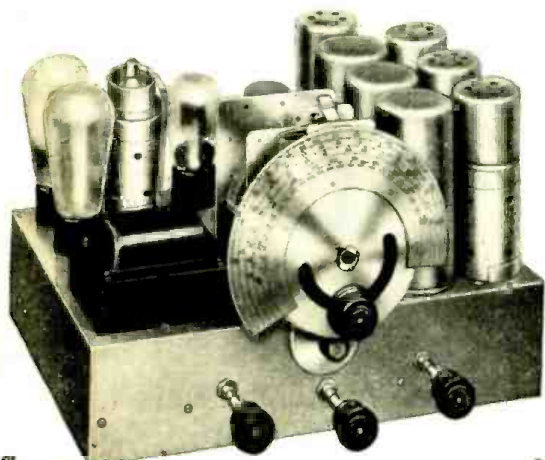

FOUR DIFFERENT FREQUENCY BANDS

Band No. 1: 194 to 555 meters covering general Broadcast wave. Band No. 2: 72.4 to 216 Meters. Band No. 3: 32.3 to 96.2 Meters and Band No. 4: 12 to 33 Meters. These bands afford coverage of Foreign Shortwave Stations, Radio Amateur Broadcasting, Aircraft and Police Calls.

This chassis designed around the NEW TYPE TUBES. A Superheterodyne circuit which minimizes the difficulties of short wave reception. The Automatic Volume Control maintains the volume of all stations received at a constant level, practically eliminating station fading.

The Tuning Control has two speeds, producing both a normal ratio and a high ratio, which is especially useful for tuning in short waves. See our catalog for full description and wholesale price.

RCA VICTOR END TABLE ELECTROLA



The R.C.A. Victor Electrola incorporates an R.C.A. Victor electric pickup, G.E. motor and automatic stop. See our catalog for full description.

YOUR COST..... **\$1250**

TRUTEST POWER TRANSFORMER

Designed to operate three or four 2.5 volt Heater tubes, one 2.5 volt power tube and one 280 or 282 rectifier. Has 700 volt C.T. 70 M.A. plate voltage. Size 3 1/8 x 3 3/4 inches. Primary: 110 volts. 50-60 cycles. Mounting dimensions 2 1/2" x 3 1/8". Specify whether 280 or 282 Rectifier is desired.

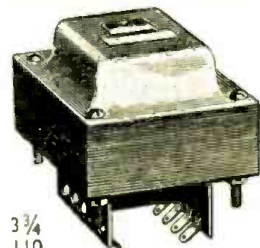

YOUR COST **\$138**

TRUTEST DRY ELECTROLYTIC CONDENSER



Trutest dry electrolytic condenser in aluminum can. Insulated single hole mounting. Capacity 8 mfd.

YOUR COST **54c**

Wholesale Radio Service Co.,
100 Sixth Ave., New York City

Please send me your New 136 page
1933 FREE CATALOGUE

NAME

ADDRESS

CITY STATE

G53

WHOLESALE RADIO SERVICE CO., Inc.

100 SIXTH AVENUE Just North of Canal St. NEW YORK, N. Y.

**STOP
HERE!**

Service Men--

An Entirely New Service for Radio Service Men

HERE is big news for every Radio Service Man. If you want a radio diagram of any commercial radio receiver ever manufactured, we are now prepared to give you

RUSH SERVICE

In the three Official Radio Service Manuals published by us so far, we are listing almost 5,000 diagrams of commercial radio sets manufactured in America.

Heretofore, you could only get these diagrams by buying our OFFICIAL RADIO MANUALS.

We have, however, had an increasing demand of late, whereby Radio Service Men who are not necessarily owners of any of the MANUALS wish to get one or more diagrams either published by us or unpublished as yet. We are now prepared to send you such diagrams on a rush order plan. We

realize that if you want one of these diagrams you want it quick. For that reason, we now have a special staff to send any special diagram out to you the same day your order is received.

If you live a distance away from us, and cannot wait for the regular mail send us 8 cents extra, and the diagram will be sent to you by air mail.

These diagrams come to you on heavy bond paper, size 9 x 12. We are prepared to furnish you every diagram you possibly can ask for with practically no exceptions, IMMEDIATELY.

HOW TO ORDER

Just tell us what diagram you want, giving us the name of the radio set, the serial number of the set, and any other information you may wish to give us. We will immediately mail you the diagram the same day your order is received.

We have a uniform charge for this service and that is **25c** for each radio diagram.

If you wish more than one diagram the price will be 25c each, but if you order six at one time, the price will be \$1.00 for the six, providing all are ordered at one time.

GERNSBACK PUBLICATIONS, INC.

(Special Diagram Department)

96-98 PARK PLACE

NEW YORK, N. Y.

Hotel Directory of the Radio Trade

The Hotels on this page are patronized by the Radio Trade. Make them your Headquarters.



In Chicago

the BISMARCK is nearest to the Merchandise Mart and the wholesale district . . . on La Salle Street, the financial center . . . the theatre district . . . and close to State Street Stores.

Large, light rooms . . . super-comfort beds . . . soft water for your bath . . . silent mail signal in each room . . . four distinctive dining rooms . . . nationally known for Good Food.

Send for Booklet with Downtown Map. Rooms with Bath, \$3.50, \$4, \$4.50, \$5, and \$6. Rooms without Bath, \$2.50.

OTTO K. EITEL, Manager

**BISMARCK
HOTEL-CHICAGO**

RANDOLPH AT LA SALLE

In ST. LOUIS



THE AMERICAN HOTEL
275 ROOMS WITH BATH
\$2.00 UP

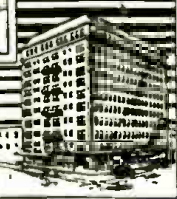

THE ANNEX
226 ROOMS WITH BATH
\$1.50 UP

The **AMERICAN HOTEL**
MARKET AT SEVENTH

The **AMERICAN ANNEX**
MARKET AT SIXTH

Our Food has made our Reputation.
COFFEE SHOP OPEN UNTIL MIDNIGHT

NASSAU · MIAMI HAVANA · CRUISES

\$115 . . . 12 3/4 DAYS

Sight-seeing trips at each port, 3 days in Nassau, 2 days in Miami, 2 1/2 days in Havana. Or take round-trip to Nassau only and stay 7 days at the Royal Victoria hotel for

\$145

FORTNIGHTLY
SAILINGS BY
S.S. MUNARGO
ON SATURDAYS

BERMUDA

\$45 ROUND TRIP

Twice weekly sailings, 21,000-ton S.S. Pan America and sister-ships, all airy, outside rooms mostly with beds and private baths. 5 days, including day at hotel in Bermuda, \$61; 7 days \$73. S.S. Pan America goes direct to dock at Hamilton.

For Information on the Free Trip Slogan Contest, see any Tourist Agent or write the Munson Lines.

All Sailings from Pier 64, N.R., New York

For further information see local tourist agent or

**MUNSON
S. S. LINES**

67 Wall St. New York
Bowling Green 9-3300

NOVEMBER SPECIALS!!

EVERY month we list on this page certain **STAR** items, which are **NOT LISTED IN OUR CATALOG**. These are all specials of which the quantities on hand are not sufficient to catalog them. **Once sold out, no more can be had.** First come, first served. **ORDER NOW, TODAY.**

STOP SHOPPING. The lowest prices are right on this page. **No one undercuts us.** We meet any price on ANY NEW Merchandise. Order direct from this page and save money. 100% satisfaction on every transaction. Take advantage of these special offers. **ORDER NOW, TODAY.**

G-M PHOTO-RELAY SWITCH For 110-20 Volts 60 Cycle A.C.

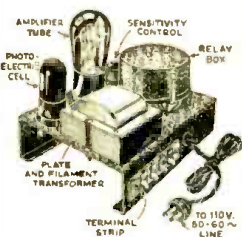

This new unit is an actual Photoelectric Relay containing all the principal parts used in the more costly industrial units. It is fully equipped with a VISTRON Type B Caesium Cell, Magnetic Relay with special winding and silver contacts.

Transformer of large capacity, Amplifier Tube, Wire-Wound Potentiometer, Condensers, Terminal Strip, Sockets, Chassis, etc. This unit can be made the foundation of such photoelectric applications as burglar alarms, door-opening equipment, illumination control, race timing, counting, control of window displays and illumination, and myriad other installations. The Photo-Switch No. 1222A—Photo-Switch. **Your Price \$15.00**

"MEGADYNE" ONE-TUBE PENTODE LOUDSPEAKER RECEIVER KIT

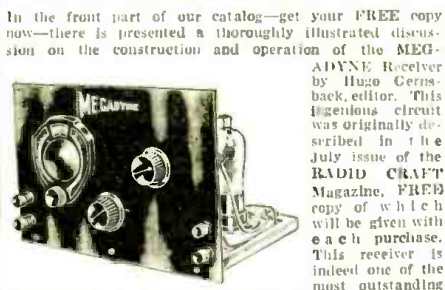

In the front part of our catalog—get your FREE copy now—there is presented a thoroughly illustrated discussion on the construction and operation of the MEGADYNE Receiver by Hugo Gernsback, editor. This ingenious circuit was originally described in the July issue of the **RADIO CRAFT** Magazine, FREE copy of which will be given with each purchase. This receiver is indeed one of the most outstanding developments in the radio industry. It is the first real one-tube receiver which will actually operate a loudspeaker. Thousands of experimenters and radio fans will want to build this remarkable receiver. For their convenience, we have compiled a complete list of parts required for its construction. These parts are of the highest quality and are exactly as specified by the author. The following parts comprise the complete kit.

1 B.M.S. Fixed Crystal Detector; 1 6-ohm Filament Rheostat; 1 3-circuit tuner for use with a .0005 mf. tuning condenser; 1 Na-ald type 481 V 5-prong socket; 1 Hammarlund Type ML-23 Variable Condenser; 2 sets of Cluch double binding posts; 1 Polymet .00025 mf. fixed condenser; 1 N-L Variocoupler; 1 Polymet .00025 mf. fixed condenser; or 1 Polymet .0005 mf. fixed condenser. (NOTE: Only one of the latter two condensers is actually employed in the circuit); 5 Fahnestock binding posts; 1 25-ft. roll of hook-up wire; 2 black Bakelite 1/2" knobs; 1 Kurz-Kasch variable reading clockwork; 1 type 38 pentode tube, "Triad" or "Speed"; 1 Bakelite panel already drilled with all holes, size 7 x 10 x 3 1/8 inch; 1 hardware assortment. The wooden base is not included.

No. 2545—Megadyne Receiver Kit. **Your Price \$10.25**

ELIMINATES NOISE AND CROSS-TALK

Service men throughout the world are beginning to realize the importance as well as the advantages obtained through the use of a shielded lead-in wire from antenna to radio receiver. More than 75 per cent of the complaints of "noisy" and "inselective" receivers may be eliminated by merely replacing the old, unshielded wire which leads from the aerial on the roof to the radio set with this new type of wire. Not only does it help to clear radio noises but to a certain extent, it makes the receiver more selective due to the capacity effect between the wire core and the metal shield. Easily installed. The wire core is connected between aerial on the roof and antenna post on receiver. The outer shield is connected to ground. Every service man should carry at least one spare roll of shielded wire in his service kit. No. 1665, 50 Ft. Roll **\$.85**
No. 1668, 100 Ft. Roll **1.60**
Shielded Lead-in Wire
Shielded Lead-in Wire



* "PEERLESS" DIRECT COUPLED AMPLIFIERS

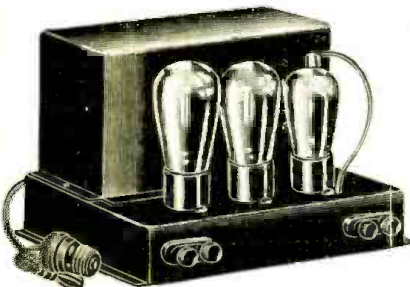

All the latest features in amplifier design have been incorporated in this direct coupled amplifier. Input terminals for permitting phonograph attachment, and in addition, by attaching the proper microphone transformer, also dry cell batteries, a microphone may be used for public address work. Any type of receiver can be connected to the input terminals without fear of loss of energy. These amplifiers are for use with dynamic speakers.

Amplifiers supply field current of 2500 ohms to dynamic speakers. Resistors are furnished when A.C. speakers are used. Amplifiers operate on 110 volts, A. C., 60 cycles.

Model SP-5003 uses 1-224, 1-245 and 1-280. Output is rated at 3 watts.

No. SP-5003—Your Price \$10.95 (less tubes) Exactly the same amplifier, but employs a power pentode in place of the 245 tube. Output 3.5 watts.

No. SP-5004—Your Price \$12.95 (less tubes) Model SP-5005 uses 1-224, 1-250 and 1-281. Consumption is 85 watts; maximum undistorted output, 6 watts. Gain rated at 1000 cycles, 55db; gain at 10,000 cycles, 51.5. Input direct to 224 control grid; output direct from 250 plate.

No. SP-5005—Your Price \$15.25 (less tubes)

* SYNCHROMATIC ELECTRIC CLOCK

Never was such a first class electric clock sold at such a ridiculously low price. An electric clock using the famous synchromatic movement. Naval observatory time right from your light socket! No spring to wind, no batteries. Never out of order. Lubricated for a life-time at the factory. Enclosed in a dust-proof and shockproof genuine molded Bakelite case. The case is of walnut-brown finish with simple but catching design. For 110 volts, 60 cycle A.C. operation only. Complete with cord and attachment plug. Size 3 3/4" x 1 3/4" x 1 1/2". Weight 1 lb. Service men now sell these fine clocks by the hundreds. Be the first in your locality to handle them.

List Price \$3.00

No. 1689—Synchromatic Electric Clock. **Your Price \$1.00**



FREE RADIO AND SHORT WAVE TREATISE



100 New Hook-Ups, Etc.
1000 Illustrations.

The new and enlarged Summer edition of our Radio and Short Wave Treatise, No. 25, has just come off the press—100 solid pages of useful information, radio items, diagrams and illustrations. Positively the greatest book in print. NOT JUST ANOTHER CATALOG. Contains a large editorial section with valuable information not found anywhere else. Considerable space is devoted to a TREATISE ON SHORT WAVES for both beginners and regular "hams." Among the new technical information listed are the following: Modernizing old radio sets—repairing speakers and headsets—making superhets out of old sets—data on constructing two-volt battery and automobile receivers—circuit of the famous Gernsback Megadyne One-Tube Loudspeaker Set—short wave coil winding data—discussion on S.W. adapters, converters and receivers, etc., etc.

WRITE TODAY. Enclose 4 cents for postage. Treatise sent by return mail.

* SILVER-MARSHALL AUDITORIUM AMPLIFIER

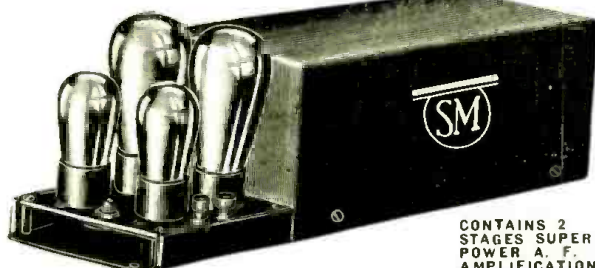

CONTAINS 2 STAGES SUPER POWER A. F. AMPLIFICATION

Ideal for theatres seating approximately 3,000 people, dance halls, schools, lectures, hospitals, auditoriums, outdoor gatherings, etc., etc. The gigantic power is at all times within control—for that matter it can be used in any home, as the volume can be regulated down to a whisper!

Supplies all necessary A, B and C, power to its own tubes. Operation requires one type X250 power tube, one X226 A.C. tube and two type X281 rectifier tubes. Attractive crystalline finish metal cabinet. 21x33x9 1/2 in. Shipping weight, 38 lbs.

No. SP-5006—Your Price \$12.75

* METALLIZED PICTAL RESISTORS AT ROCK BOTTOM PRICES

A very fortunate purchase enables us to offer these fine resistors at prices which surprise even ourselves—prices more than three times lower than in our own catalog. Resistors are guaranteed to maintain their ohmage under even adverse operating conditions. The resistance element is based on the famous metallized principle which has proven its superiority wherever accuracy and uniformity are paramount requisites. The special ceramic casing of these resistors is of sturdy construction and affords maximum heat dissipation. A feature of these resistors is their molded end-caps, tapered so they can be mounted in all standard resistor mounts. By means of their pictails, they may also be soldered in any convenient position. Available in the following sizes—all rated at one watt: 300, 450, 600, 8,000, 10,000, 12,000, 370,000. Act fast to take advantage of this offer, as the supply is limited. Sold only in lots of six or more.



Values Clearly Marked on Each Unit

No. SP2226, Metallized Resistors, NOW YOUR PRICE 6c EACH only in lots of six or more.

* PORTABLE PUBLIC ADDRESS SYSTEM

Comprises Microphone Loftin-White Amplifier and Dynamic Speaker. A recently completed all-electric A.C. development incorporating all the features and advantages of the direct-coupled Loftin-White Amplifier principle. The amplifier is a high quality two stage job, having some RADICALLY NEW IDEAS IN AUDIO FREQUENCY AMPLIFICATION and embodying a 25, 1.25 power tube and 1 300 full-wave rectifier. It is remarkably free from A.C. hum.

The design is adaptable to all purposes, i.e., microphone, radio and phonograph. Has an undistorted power output of approximately 3.5 watts; SUFFICIENT TO OPERATE FROM 2 TO 4 ADDITIONAL DYNAMIC SPEAKERS.

The portable address system is sold COMPLETE WITH THE NEW R.C.A. VICTOR HAND MICROPHONE.

Put up in a single compact and perfectly balanced carrying case, the front of which is utilized as a handle for the self-contained dynamic speaker. Complete with microphone and accessories the weight is only 30 pounds. For 50-60 cycles, 110-120 volts A.C. operation, Shipping weight, 38 pounds.

List Price, \$75.00
No. SP-5011—Versatile Portable Address System. Your Price, complete with microphone... **\$24.95**

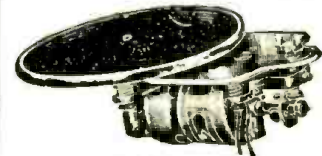

* PRIME "GREEN GIANT" Electric Phonograph Motor

Induction type model with newly improved, humpless motor. Equipped with speed regulator, also "on and off" switch. Completely equipped with large turn-table—takes records up to 12" in diameter. An ideal motor for electrifying the old phonograph. When used in conjunction with any amplifier on this page superb electrical reproduction is obtained.

No. 100—Your Price \$7.50

WE ARE A WHOLESALE HOUSE AND CANNOT ACCEPT ORDERS FOR LESS THAN \$3.00.

If C. O. D. shipment is desired, please remit 20% remittance, which must accompany all orders.

If full cash accompanies order, deduct 2% discount. Send money order—certified check—U. S. stamps.

Radio Trading Co.
23 West Broadway
New York, N. Y.

ORDER FROM THIS PAGE. You will find special prices from time to time in this magazine. Get our big FREE catalog for the greatest Radio Bargains.

Should you wish goods shipped by parcel post, be sure to include sufficient extra remittance for same. Any excess will be refunded.

WRITE TO-DAY FOR FREE 100 PAGE CATALOG Fall Edition

Our New WHOLESALE CATALOG is highly treasured by all P.A. men, Servicemen, Experimenters, Institutions, Dealers, Etc. It contains listings of thousands of items... all BIG BARGAINS and fully guaranteed! The variety of our listings embraces everything of genuine merit

and value, from a lowly lug or screw to a 100 WATT Double Channel Rack and Panel P.A. Amplifier. Our Catalogs have often been referred to as a MODERN ENCYCLOPEDIA OF THE RADIO INDUSTRY... they are actually a liberal Radio Education!

HEADQUARTERS for Public Address Amplifier Installations

We manufacture a wide choice of Class "A" and "B" P.A. Amplifiers producing undistorted outputs ranging from 4 to 100 WATTS! Special

models are available for SOUND TRUCKS, and for single or dual channel RACK AND PANEL SYSTEMS.

WE CANNOT BE UNDEESOLD! WE ARE MANUFACTURERS SELLING DIRECT TO YOU AND SAVE YOU BIG MONEY!

"COAST-TO-COAST" UNIVERSALLY OPERATED (FROM STORAGE BATTERY OR 110 VOLT 60 CYCLE A.C.) SOUND TRUCK, AUTOMOBILE AND AUDITORIUM PUBLIC ADDRESS 15 WATT AMPLIFIER

A SUPERB INSTRUMENT FOR PHONO, PICK-UP, RADIO TUNER OR MICROPHONE AMPLIFICATION! The "COAST-TO-COAST" Auto A.C. Power Unit illustrated is connected to your car storage battery, and the 110 Volt 60 Cycle A.C. Output of same is then fed to the amplifier. Another cable is also attached to the storage battery—this provides filament current for all the amplifier tubes, except the 82 Rectifier (which is lit from the A.C. supply furnished by the AUTO A.C. Unit.) You can use from 1 to 8 horn or cone type 6 volt D.C. Dynamic Speakers, obtaining their field excitation from the same storage battery. Operating the tube filaments and exciting the speaker field from the car storage battery considerably lessens the drain upon the Auto A.C. Power Unit, were same to furnish the necessary A.C. Filament supply and field excitation. The wisdom therefore of our system is self obvious! Assuming your daily requirements necessitate the alternate use of this Amplifier in a Sound Car, and, also possibly from a light socket (either indoors or outdoors), all you have to do is disconnect the plug leading to the AUTO A.C. Power Unit, and insert it into a 110 Volt A.C. 50-60 cycle socket, at the same time throwing a switch (located on the amplifier chassis), which disconnects the filaments from the car battery and connects them instead to a self-contained separate 6.3 volt secondary on the Amplifier's A.C. Power Transformer. An A.C. Rectifier can be provided to use the self-same 6 volt D.C. Dynamic Speaker on an A.C. installation, without any further changes.

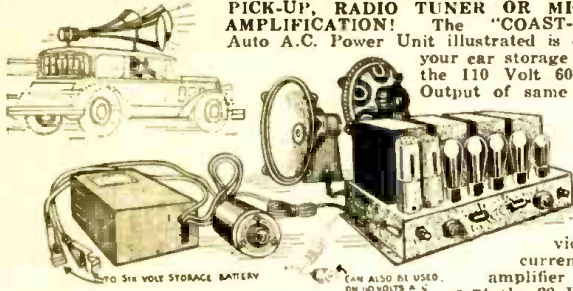

Incorporates Valuable Electrical and Mechanical Features
Built upon a heavy attractive black shrieved Steel Chassis, 17 1/2 in. long, 9 in. wide, 8 1/2 in. high. The Power Transformer is air-cooled, and is designed to carry its full load, without overloading or overheating. A Multiple Choke Filtering System employed assures Hum-Free operation and reproduction, even if a Radio Tuner is used with this Superb Amplifier. The audio stages are designed to give a flat frequency response curve from 30 cycles up to 10,000 cycles. A pleasingly effective Tone Control and smoothly graduated Universal Input Volume Control serves a much needed purpose indeed. Three separate Twin Jacks are provided: one for additional speakers, one for Phono-Pick-Up or Microphone (or Control Panel), and the other for Radio Tuner Input. Switches are also provided for the power line, and one for Phono-Radio. Provision is made on the rear of the chassis for the installation of up to 7 UY Sockets, to serve as Speaker terminals. A 100% Protection fuse block is self-contained. If more than one speaker will be used, you will require a suitable output coupling transformer, \$8.75 additional. On 110 Volt Public Utility A.C. Socket power installations—you will require a Special FIELD CURRENT EXCITER that provides the necessary 6 volt D.C. field current, figured at the rate of \$7.50 per speaker to be excited.

The Auto A.C. POWER SUPPLY is furnished in two units, one, the converter mechanism itself, and two, the control unit and A.C. Voltage Outlet. The converter is enclosed in a compact steel shielded case, measuring 7 1/2 x 6 1/2 x 4 in. tall. Mounting hole provisions are furnished. The control unit can be mounted right on any automobile dash-board or steering wheel post. Heavily insulated and weather-proofed leads (45 in. long) with powerful battery clips are furnished. Can be mounted in any position, and is generally fastened within the hood, or the cowl.
Produces 110 volts, 60 cycles, A.C. at 65 watts. *Factory wired, ready for operation, \$49.50*
(This amplifier only requires 55 watts, leaving an ample 10 watt reserve.)

- 15-WATT AMPLIFIER **\$37.50**
- (KIT MODEL, assembled but unwired).....
- Set of 7 Tubes (2-237, 4-42, 1-82).....\$ 9.06
- AUTO A.C. POWER UNIT..... 27.15
- JENSEN 6 VOLT "CONCERT" DYNAMIC SPEAKER..... 6.95

T.C.A. 110 VOLT A.C. AND D.C. (2500 OHM) DYNAMIC SPEAKERS
9 1/2 in. diameter, Bortex Cloth Diaphragm. Equipped with output push-pull transformer—state power tubes employed.

110 Volt D.C. Model (2500 ohm field) **\$2.95**
110 Volt A.C. Model—equipped with 280 Rectifier tube.....\$8.95

245-247 "MIOGET" A.C. TRANSFORMER
Primary: 115 Volts, 60 cycles; Secondaries: 350-350 Volts, center tapped, at .050 amps.; 2.5 Volts, center tapped, 7 amps.; for 4 to 7 tubes; 5 volts, 2 amps., for 1-280. Mounting holes: 2 9/16 inch x 3 1/4 inch..... **\$1.65**

33 1/3 AND 78 R.P.M. DUAL SPEED ELECTRIC PHONO MOTOR
Governor controlled. Instantaneous choice of either speed. Automatic stop. 12 in. turntable and all fittings included. For 110 volt, 50-60 cycle A.C. **\$10.75**

GENERAL ELECTRIC 78 R.P.M. PHONO MOTOR
Complete with 12 in. turntable, automatic speed control, etc. Powerful torque. **\$7.95**

33 1/3 AND 78 R.P.M. PHONO PICK-UP
Ultra sensitive. Equipped with volume control. No finer pick-up available. **\$7.95**

UNIVERSAL DOUBLE BUTTON CARBON MICROPHONE
Exceptionally sensitive. Pure gold contacts. Duraluminum diaphragm. Frequency Response: 40 to 3500 cycles! Resistance: 200 ohms per button... **\$5.88**

RCA PHOTOPHONE D.C. and A.C. DYNAMIC SPEAKERS
Handles peak loads up to 15 Watts! 1 1/2 in. over-all diameter. 15 ohm voice coil. Considered the finest speaker available!

110 Volt D.C. Model, 1000-ohm Field Coil **\$6.95**
110 Volt D.C. Model, 2500-ohm Field Coil.....\$11.95
110 Volt A.C. Model, Equipped with 1-82 Mercury Vapor Rectifier Tube, 12.25
6 Volt D.C. Model (For Sound Trucks) 15.00
Cast Iron Baffle (Illustrated)..... 1.95
Output Transformer for 2-250 Tubes, 4.75
Output Transformer for 2-46 Class "B" Tubes..... 6.75

GENERAL ELECTRIC PHONO-TABLE
Contains a GE Heavy Duty, steady speed Induction Motor, and GE electric phono pick-up with Inertia Tone Arm). Speed Control, Volume Control, and Automatic Stop. A Switch is also provided for optional use of Radio or Phonograph, as well as an On-Off Switch, a Phono Pick-up Impedance matching transformer. The End Table is easily worth \$20.00 by itself! The finest of dull polished genuine walnut woods are used. Note sliding cover and amplifier shelf, 24 in. tall, 26 in. long, 15 in. wide. For 110 Volt, 50-60 cycle A.C. **\$12.95**
25 cycle.....\$15.95

4 TUBE 10-TO 200 METER SUPER-METER-DYNE A.C. OPERATED SHRT WAVE CONVERTER
Employs 1-57, 1-56, 1-58, 1-280 tubes. Plug into any 110 volt, 50-60 cycle A.C. line—attach to ANY 200 to 500 Meter broadcast receiver. Automatic wave hand switching—requires no plug-in coils. Contains valuable 200-350 meter antenna booster feature... **\$13.50**

THORARSON GIANT SIZE 200 MIL. 1400 VOLT 250 TYPE A.C. POWER TRANSFORMER
Dimensions: 6 in. tall, 4 1/2 in. long, 3 1/2 in. wide—shipping weight, 18 lbs. 1 Primary: 120 volts, tapped at 100 and 110 volts. Wattage rating: 375 watts! Secondaries: High voltage, 700-700 (at no load), 1300 volts at 200 mils., center tapped. Fil. No. 1: 7.5 volts, 2.5 amps., center tapped. Fil. No. 2: 7.5 volts, 2.5 amps., center tapped. Fil. No. 3: 2.5 volts, 11.0 amps., center tapped. Fil. No. 4: 1.5 volts, 2.0 amps., center tapped. (This latter winding does not have to be used, but is available if ever necessary.) **\$6.95**

26 WATT FOUR STAGE CLASS "B" SOUND TRUCK AND AUDITORIUM PUBLIC ADDRESS AMPLIFIER
Employs 2-56, 2-46, 1-83 Tubes. Draws 110 Watts. Ideal for sound Trucks. If desired, can furnish D.C. Field Excitation to front one to four Trucks. 1000 ohm, or from one to eight 2500 ohm horn or cone type dynamic units. Can also operate 1 to 8 A.C., or externally self rectified speakers. Contains microphone pre-amplifier stage. Excellent for amplification of Phono-Microphone or Radio Tuner inputs. Fully described in our catalog **\$59.50**

SUPER-METERODYNE I.F. AND R.F. COIL KIT
Comprises 1-1 Gang .00036 Mf. Oscillator Tracker section equipped Dejar Variable condenser, 1—Loosely coupled 175 K.C.I.F. unit; 2—Closely coupled I.F. Unit; 1-Band Pass Pre-Selector Antenna Coil; 1-Detector Oscillator and R.F. Coupling Coil; 1-22 Millihenry R.F. Choke; 2—Fully descriptive "Super-Het." Blue Print diagrams. All coils fully shielded **\$9.75**

245-247 TYPE POWER TRANSFORMER
Furnished with two 2 1/2 Volt Windings! For 7-2 1/2 Volt (1.75 amp.) or 12-1.0 amp tubes, 2-245 or 247, 1-280, 115 volt A.C. Primary, 375-375 volt, 110 M.A. high voltage secondary, center tapped, 2.5 volt, 12.25 amps., center tapped, for 7 to 12 2 1/2 volt tubes; 2.5 volt, 3.0 amps., center tapped, for 1 or 2-247's, or 247's; 5.0 volt, 2.0 amps., center tapped for 1-280. Mounting holes: 3/4 in. x 2 1/4 in. 4 1/4 in. high. **\$2.65**
Rated: 85 watts.....

WESTON METER EQUIPPED SET AND TUBE ANALYZER
Makes These Ten Vital Tests—Rivals the performance of much more costly and bulkier set analyzers and tube tester! (Employs a 1000 ohm per volt WESTON METER); TEST No. 1: D.C. Volts, 1000, 500, 250, 50, 10, 5; TEST No. 2: A.C. Volts, 1000, 500, 250, 50, 10, 5; TEST No. 3: D.C. mils, 100, 20, 5, 1; TEST No. 4: A.C. mils, 0 to 1; TEST No. 5: Ohms 5 to 10,000; TEST No. 6: Ohms 0 to 100,000; TEST No. 7: Capacity, .0001 to 6 mfd. (in two ranges); TEST No. 8: Frequency, 10 to 1000 cycles; TEST No. 9: Tube Tester (Tests ALL Tubes—including latest 7 Probe types!); TEST No. 10: COMPLETE SET ANALYZER.

Makes these following voltage readings: Plate to Filament, Plate to Cathode, Plate to Grid, Screen-Grid to Filament, Screen-Grid to Cathode, Grid to Cathode, Space Charge Grid, Pentode Grid, Filament Voltage, Rectifier Plate Voltages (A.C. and D.C.) Filament to Chassis, Grid to Chassis, Plate to Chassis, etc., etc., etc. Furnished complete with following accessories: Highly insulated Test Cables and Prods, with readily removable phono needle contacts; Seven wire extension cable with 6 prong Test Plug and 4-5-7 prong adapters; Calibration Charts; Full instructions, etc. 8 1/2 x 8 1/2 x 4 1/2. Fully assembled—ready for immediate use! **\$39.50**

ORDER FROM THIS PAGE. All prices shown on this page are subject to a 2% cash discount ONLY if a full cash remittance is sent with order. C.O.D. shipments are made on receipt of 20% deposit remittance. We accept checks, stamps, and money orders. All our merchandise is

FULLY GUARANTEED and your satisfaction is accordingly unreservedly assured. You will find it a pleasure to confine your purchases to the responsible "HOUSE OF COAST-TO-COAST." When in New York, by all means visit our SALES-ROOMS—free auto parking!

COAST-TO-COAST RADIO CORP.

123-R West 17th St., New York N.Y.

STAND BY

FOR THE "SUPREME" 1933 Service Instruments



SUPREME DIAGNOMETER
AAA1—\$147.50



SUPREME TUBE-O-METER
Model 66—\$59.75 Stand, extra \$7.50



SUPREME ANALYZER
Model 56—\$56.25

All prices net f. o. b.
Greenwood, Miss.

See these jobbers today

"SUPREME" DISTRIBUTORS

- ALABAMA**
Birmingham Birmingham Electric Battery Co.
Mobile McGowan, Lyons Hardware Co.
- ARKANSAS**
Little Rock Pones Bros. Hardware Co.
- CALIFORNIA**
Los Angeles Kierulff & Ravenscroft, Inc.
San Francisco Kierulff & Ravenscroft, Inc.
- COLORADO**
Denver Hendrie & Bolthoff Mfg. & Supply Co.
- CONNECTICUT**
Hartford Hairy & Young, Inc.
Radio Inspection Service Co.
- DISTRICT OF COLUMBIA**
Washington Capitol Radio Wholesalers
- GEORGIA**
Savannah Frank Corporation
- ILLINOIS**
Chicago Newark Electric Company
Springfield Central Auto Equipment Co.
- INDIANA**
Indianapolis Van Camp Hardware & Iron Company
- IOWA**
Dubuque Crescent Electric Supply Company
- KENTUCKY**
Louisville Harbison & Gathright, Inc.
- PADUCAH**
Rhodes-Burford Company
- LOUISIANA**
New Orleans Carline-Harang Mach. & Supply Co.
Electrical Supply Company
- MAINE**
Randolph O'Connor & Moran
- MARYLAND**
Baltimore Stewart-Warner Sales Company
- MASSACHUSETTS**
Boston Sager Electric Supply Co.
- MICHIGAN**
Lansing N. L. Offenauer

Send coupon, now, for complete catalog, showing all the new SUPREME INSTRUMENTS, kits, combinations and service-men's parts and accessories.

Now... the name "SUPREME" glows with added lustre as the most diversified service line in the industry—over thirty new instruments, combinations and kits, and myriad attractively priced parts and accessories.

Ask any of the "service-jobbers" listed on this page—get a demonstration of the instrument that every real radio-man wants—SUPREME DIAGNOMETER AAA1. Explore the pages of the interesting, new, free catalog, waiting for you. Try any and every make of instrument, but buy none until you have seen the "SUPREME" 1933 product—"Supreme by Comparison."

SUPREME INSTRUMENTS CORPORATION,
442 Supreme Bldg., Greenwood, Miss.
Send me, free of cost or obligation, the 1933 SUPREME SERVICE catalog, now ready.

Name _____
Address _____
City _____ State _____
Jobber's Name _____
Address _____

- MINNESOTA**
Minneapolis Jalsco Manufacturing Co.
Winne Sales Company
- MISSOURI**
Kansas City Sterling Radio Company, Inc.
St. Louis Van-Ashe Radio Company
Walter-Ashe Radio Company
- NEW HAMPSHIRE**
Manchester Radio Service Laboratory
- NEW YORK**
New York City Sun Radio Company
Wholesale Radio Service Co.
- Schenectady**
Maurice Schwartz & Son
- NORTH CAROLINA**
Zebulon W. B. Bunn & Company
- OHIO**
Cincinnati M. W. Fantle Co.
- Cleveland**
The M & M Company
- OKLAHOMA**
Tulsa Oklahoma Radio Manufacturing Co.
- OREGON**
Portland Wedel Company, Inc.
- PENNSYLVANIA**
Philadelphia M & H Sporting Goods Company
- TENNESSEE**
Gallatin J. A. Sloan Company
Memphis Orfill Brothers & Co.
- TEXAS**
Austin Walter Tips Company
San Antonio Southern Equipment Company
- WASHINGTON**
Seattle Wedel Company
Spokane Spokane Radio Company
- WEST VIRGINIA**
Charleston Bond-Ryder-Jackson Company
- WISCONSIN**
Milwaukee Radio Parts Company
Sheboygan J. J. Koepsell Company

SM

For the first time in history a receiver is guaranteed to outperform, on every count, any other radio right in your own home—or your money back!

McMurdo Silver
McMurdo Silver

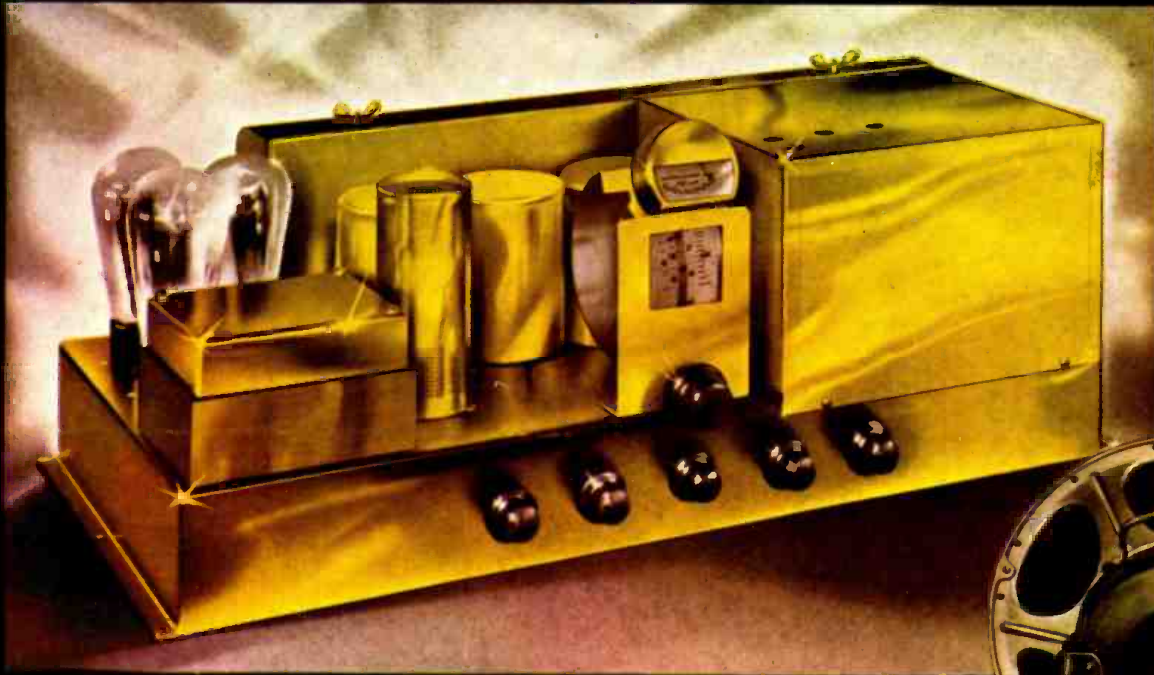

The NEW CB-1

If the finest of anything can have a price—that should be the price of the CB1. It is Silver-Marshall's *Custom-Built* sister radio to the 728SW. It has 13 tubes with "bong" enough to fill a cathedral. Its speaker is an exclusive new auditorium model that, alone, weighs 42 pounds, with a voice coil 2½ inches in diameter—equivalent to 4 ordinary speakers and an extra stage of audio. That speaker is rated at 15 watts, giving the receiver an all-wave sensitivity almost impossible to measure.

Into the CB1 has been built every feature known to the S-M Laboratories. And they have produced 39 major radio developments in the last eight years!

We could go on for pages listing its technical perfections, No wonder it is brass plated, brushed, buffed and lacquered like the finest laboratory instrument. It is a laboratory instrument. And each one personally tested and approved by McMurdo Silver.

Available both as a matched assembly installed in a beautiful accoustically selected cabinet and as a chassis.

And remember—guaranteed to outperform anything at any price—or your money back.

Why is Silver-Marshall Custom Built equipment used by the United States Navy on the Akron, the largest dirigible in the world?

Why is it used as official equipment by important airports in all parts of the country?

Why do you find it on famous sea-going private yachts?

Why is it selected by the Chief Engineers of almost every important broadcasting station?

Write for technical description, logs of world-wide reception and prices.

SILVER-MARSHALL, Inc.
6419 WEST 65th STREET " " " " CHICAGO, U. S. A.